

## ARTWORK

Master Ref: **PHL464774**  
 TR Ref: **TR2145372**  
 Brand: PHILIPS  
 Brand execution: Moodlighting  
 Product name:  
 Article Number: N/A  
 Region: Trident UK  
 Template Ref: As Previous  
 Artwork 12NC: 442294742402  
 Die cut 12NC:  
 Barcode: N/A  
 CRC Number:  
 Action: **C**  
 Date: 25/05/2021

Project Manager: Margarita Papoutsi

Trident Artist: Samantha Reilly

Technical & Non Printing Items

■ Dieline
 ■ Guides

Colours:



# PHILIPS



TRIDENT

Trident UK, Connaught House, Connaught Road,  
 Kingswood Business Park, Hull, HU7 3AP, England.  
 T: +44 (0) 01482 828100

Please note that any low resolution paper Canon colour  
 copies associated with this job should be referred to for  
 content, layout and colour separation only.

UNDER NO CIRCUMSTANCES SHOULD THIS  
 ARTWORK BE ALTERED WITHOUT PRIOR  
 PERMISSION FROM TRIDENT.



# ARTWORK

Master Ref: **PHL464774**  
TR Ref: **TR2145372**  
Brand: PHILIPS  
Brand execution: Moodlighting  
Product name:  
Article Number: N/A  
Region: Trident UK  
Template Ref: As Previous  
Artwork Ref: 442294742402  
Die cut 12NC:  
Barcode: N/A  
CRC Number:  
Action: **C**  
Date: 25/05/2021

Project Manager: Margarita Papoutsis

Trident Artist: Samantha Reilly

Technical & Non Printing Items

 DieLine  Guides

Colours:



# PHILIPS



Trident UK, Connaught House, Connaught Road,  
Kingswood Business Park, Hull, HU7 3AP, England.  
T: +44 (0) 01482 828100

Please note that any low resolution paper Canon colour  
copies associated with this job should be referred to for  
content, layout and colour separation only.

UNDER NO CIRCUMSTANCES SHOULD THIS  
ARTWORK BE ALTERED WITHOUT PRIOR  
PERMISSION FROM TRIDENT.

100 mm

120 mm

Incl. / В коробке

**A** 

**B** 

UK only  
только для  
Великобритании

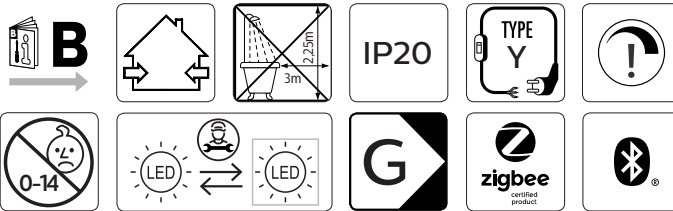
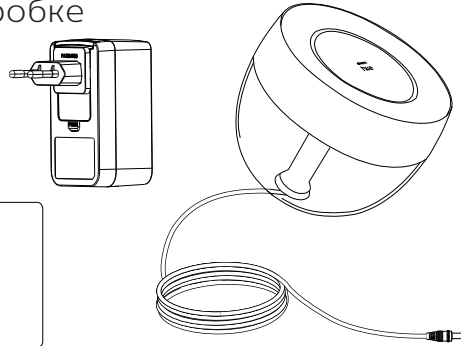

2

# ARTWORK

Master Ref: **PHL464774**  
TR Ref: **TR2145372**  
Brand: PHILIPS  
Brand execution: Moodlighting  
Product name:  
Article Number: N/A  
Region: Trident UK  
Template Ref: As Previous  
Artwork Ref: 442294742402  
Die cut 12NC:  
Barcode: N/A  
CRC Number:  
Action: **C**  
Date: 25/05/2021

Project Manager: Margarita Papoutsi

Trident Artist: Samantha Reilly

Technical & Non Printing Items

■ Dieline ■ Guides

Colours:



# PHILIPS



Trident UK, Connaught House, Connaught Road,  
Kingswood Business Park, Hull, HU7 3AP, England.  
T: +44 (0) 01482 828100

Please note that any low resolution paper Canon colour  
copies associated with this job should be referred to for  
content, layout and colour separation only.

UNDER NO CIRCUMSTANCES SHOULD THIS  
ARTWORK BE ALTERED WITHOUT PRIOR  
PERMISSION FROM TRIDENT.

100 mm

120 mm

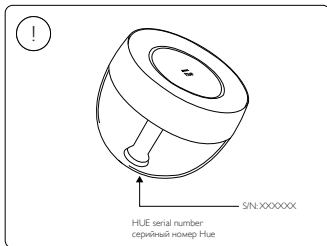
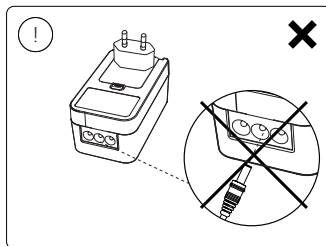
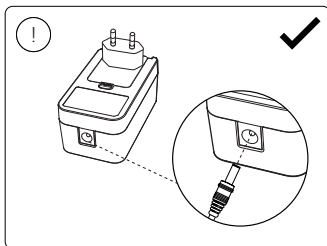
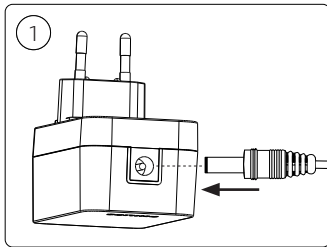

3

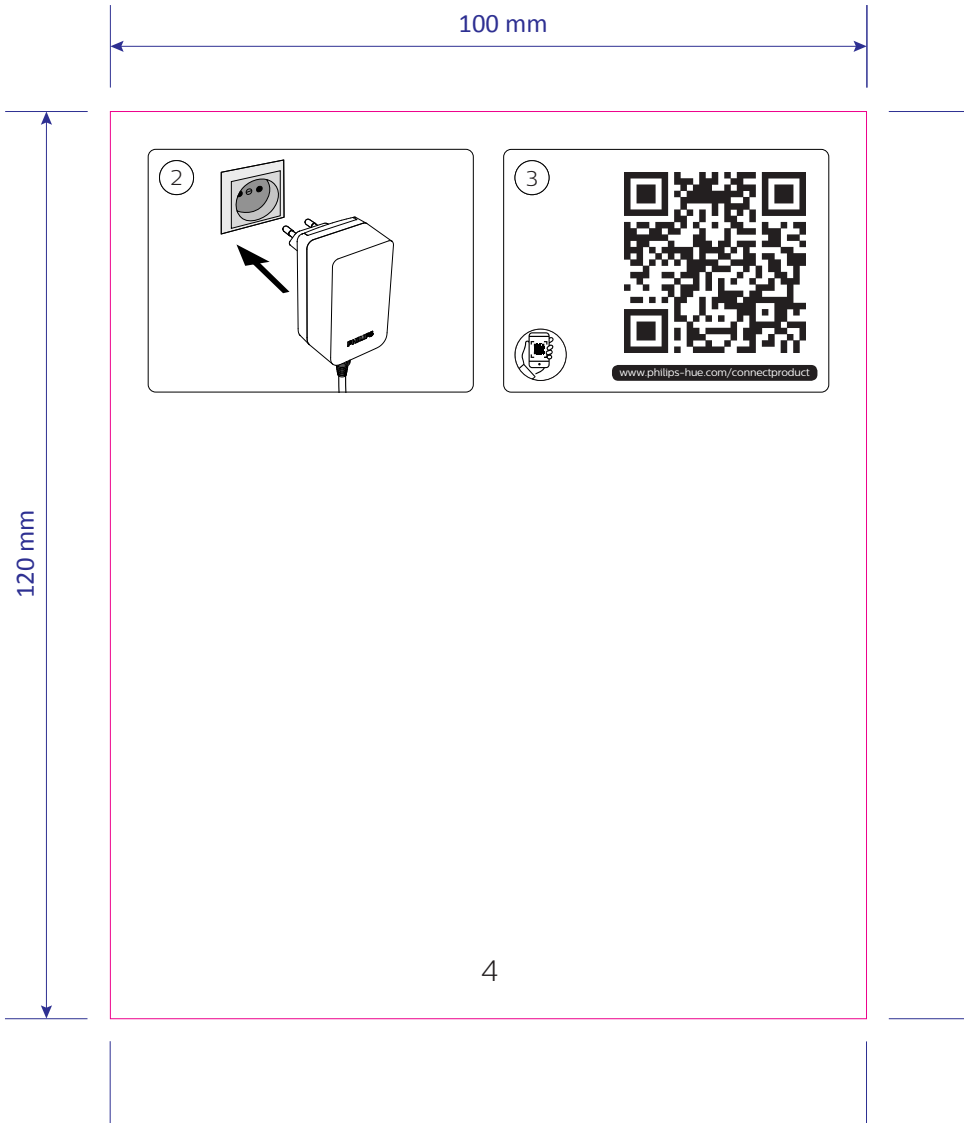

# ARTWORK

Master Ref: **PHL464774**  
 TR Ref: **TR2145372**  
 Brand: PHILIPS  
 Brand execution: Moodlighting  
 Product name:  
 Article Number: N/A  
 Region: Trident UK  
 Template Ref: As Previous  
 Artwork Ref: 442294742402  
 Die cut 12NC:  
 Barcode: N/A  
 CRC Number:  
 Action: **C**  
 Date: 25/05/2021

Project Manager: Margarita Papoutsis

Trident Artist: Samantha Reilly

Technical & Non Printing Items  
■ Dieline ■ Guides

Colours:

Black	1
	3TH

# PHILIPS



Trident UK, Connaught House, Connaught Road,  
 Kingswood Business Park, Hull, HU7 3AP, England.  
 T: +44 (0) 01482 828100

Please note that any low resolution paper Canon colour copies associated with this job should be referred to for content, layout and colour separation only.

UNDER NO CIRCUMSTANCES SHOULD THIS ARTWORK BE ALTERED WITHOUT PRIOR PERMISSION FROM TRIDENT.

# ARTWORK

Master Ref: **PHL464774**  
TR Ref: **TR2145372**  
Brand: PHILIPS  
Brand execution: Moodlighting  
Product name:  
Article Number: N/A  
Region: Trident UK  
Template Ref: As Previous  
Artwork Ref: 442294742402  
Die cut 12NC:  
Barcode: N/A  
CRC Number:  
Action: **C**  
Date: 25/05/2021

Project Manager: Margarita Papoutsi

Trident Artist: Samantha Reilly

Technical & Non Printing Items

■ DieLine ■ Guides

Colours:

Black	1
	3th

# PHILIPS



Trident UK, Connaught House, Connaught Road,  
Kingswood Business Park, Hull, HU7 3AP, England.  
T: +44 (0) 01482 828100

Please note that any low resolution paper Canon colour  
copies associated with this job should be referred to for  
content, layout and colour separation only.

UNDER NO CIRCUMSTANCES SHOULD THIS  
ARTWORK BE ALTERED WITHOUT PRIOR  
PERMISSION FROM TRIDENT.

100 mm

120 mm

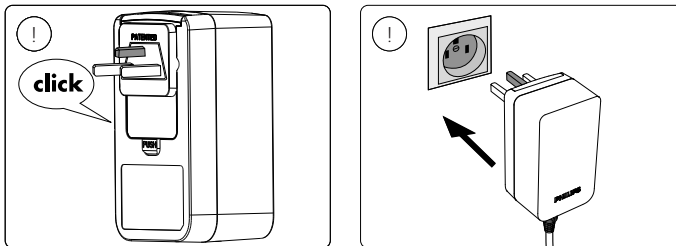
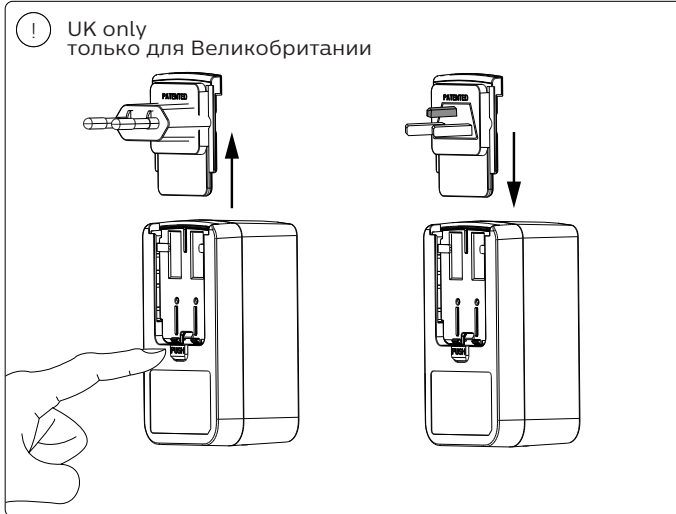

5

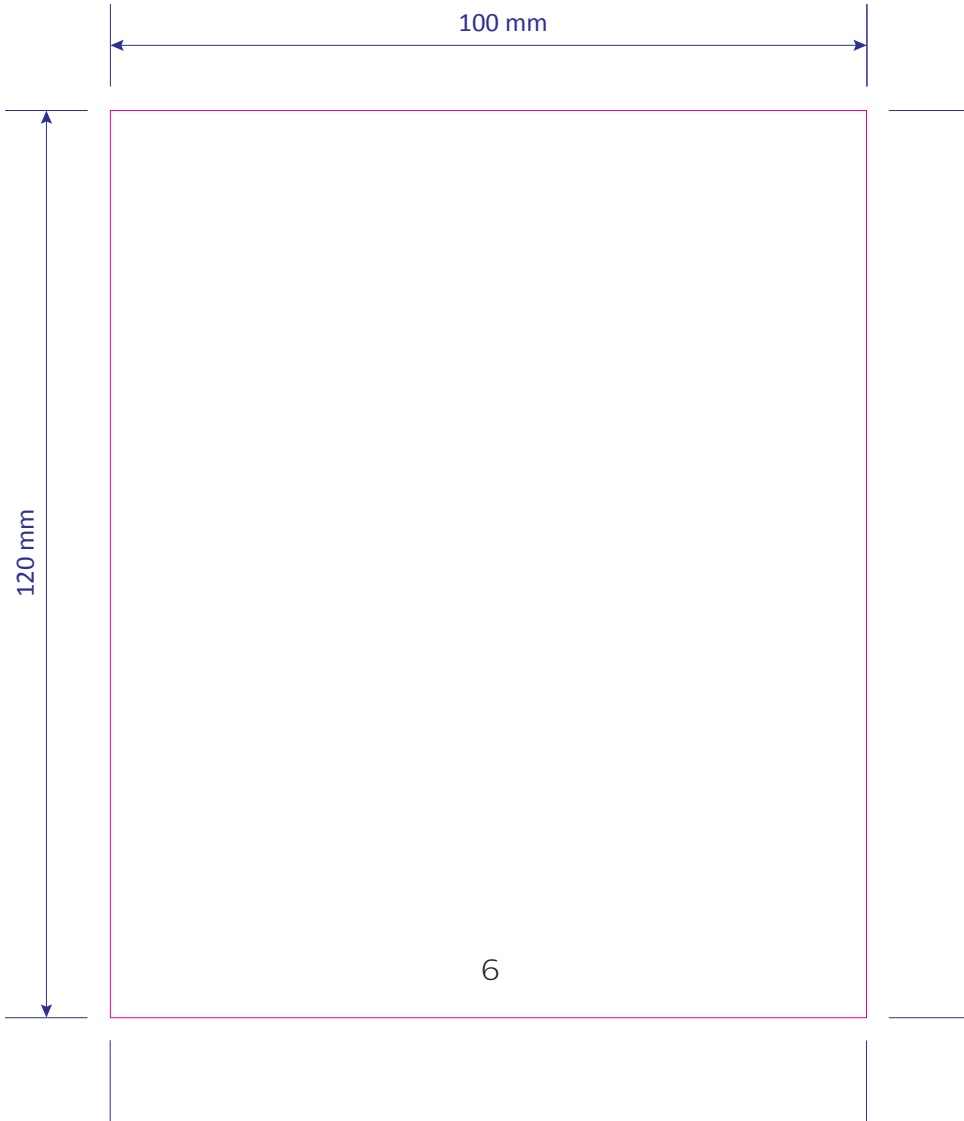

## ARTWORK

Master Ref: **PHL464774**  
TR Ref: **TR2145372**  
Brand: PHILIPS  
Brand execution: Moodlighting  
Product name:  
Article Number: N/A  
Region: Trident UK  
Template Ref: As Previous  
Artwork 12NC: 442294742402  
Die cut 12NC:  
Barcode: N/A  
CRC Number:  
Action: **C**  
Date: 25/05/2021

Project Manager: Margarita Papoutsi

Trident Artist: Samantha Reilly

Technical & Non Printing Items

 Dieline  Guides

Colours:



# PHILIPS



TRIDENT

Trident UK, Connaught House, Connaught Road,  
Kingswood Business Park, Hull, HU7 3AP, England.  
T: +44 (0) 01482 828100

Please note that any low resolution paper Canon colour  
copies associated with this job should be referred to for  
content, layout and colour separation only.

UNDER NO CIRCUMSTANCES SHOULD THIS  
ARTWORK BE ALTERED WITHOUT PRIOR  
PERMISSION FROM TRIDENT.

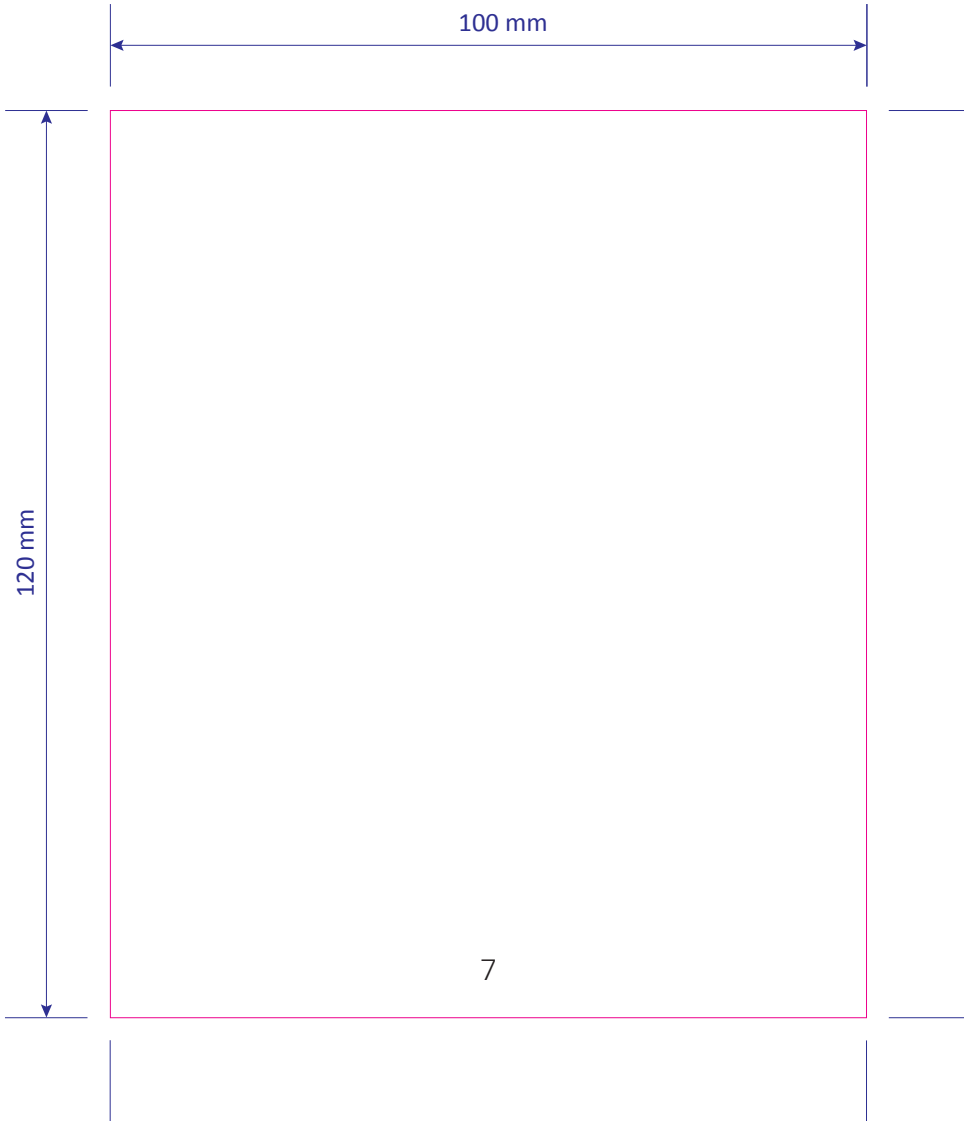

## ARTWORK

Master Ref: **PHL464774**  
TR Ref: **TR2145372**  
Brand: PHILIPS  
Brand execution: Moodlighting  
Product name:  
Article Number: N/A  
Region: Trident UK  
Template Ref: As Previous  
Artwork 12NC: 442294742402  
Die cut 12NC:  
Barcode: N/A  
CRC Number:  
Action: **C**  
Date: 25/05/2021

Project Manager: Margarita Papoutsi

Trident Artist: Samantha Reilly

Technical & Non Printing Items

 Dieline  Guides

Colours:



# PHILIPS



TRIDENT

Trident UK, Connaught House, Connaught Road,  
Kingswood Business Park, Hull, HU7 3AP, England.  
T: +44 (0) 01482 828100

Please note that any low resolution paper Canon colour  
copies associated with this job should be referred to for  
content, layout and colour separation only.

UNDER NO CIRCUMSTANCES SHOULD THIS  
ARTWORK BE ALTERED WITHOUT PRIOR  
PERMISSION FROM TRIDENT.

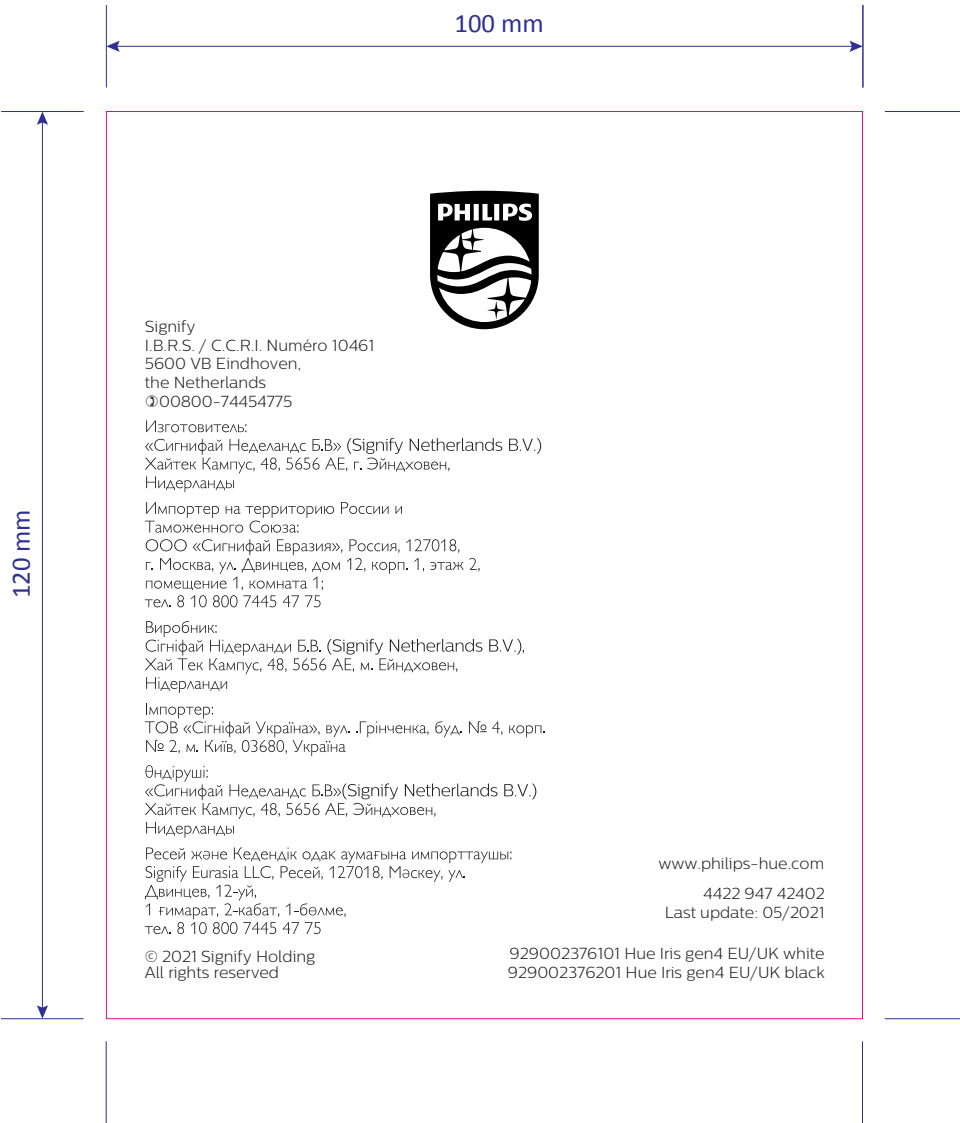

100 mm

120 mm



Signify  
I.B.R.S. / C.C.R.I. Numéro 10461  
5600 VB Eindhoven,  
the Netherlands  
00800-74454775

Изготовитель:  
«Сигнифай Неделандс Б.В» (Signify Netherlands B.V.)  
Хайтек Кампус, 48, 5656 АЕ, г. Эйндохвен,  
Нидерланды

Импортер на территорию России и  
Таможенного Союза:  
ООО «Сигнифай Евразия», Россия, 127018,  
г. Москва, ул. Двинцев, дом 12, корп. 1, этаж 2,  
помещение 1, комната 1;  
тел. 8 10 800 7445 47 75

Виробник:  
Сігніфай Нідерланди Б.В. (Signify Netherlands B.V.),  
Хай Тек Кампус, 48, 5656 АЕ, м. Ейндховен,  
Нідерланди

Імпортер:  
ТОВ «Сігніфай Україна», вул. Грінченка, буд. № 4, корп.  
№ 2, м. Київ, 03680, Україна

Өндіруші:  
«Сигнифай Неделандс Б.В»(Signify Netherlands B.V.)  
Хайтек Кампус, 48, 5656 АЕ, Эйндохвен,  
Нидерланды

Ресей және Кедендік одақ аумағына импорттаушы:  
Signify Eurasia LLC, Ресей, 127018, Мәскеу, ул.  
Двинцев, 12-үй,  
1 ғимарат, 2-жабат, 1-бөлме,  
тел. 8 10 800 7445 47 75

www.philips-hue.com  
4422 947 42402  
Last update: 05/2021

© 2021 Signify Holding  
All rights reserved

929002376101 Hue Iris gen4 EU/UK white  
929002376201 Hue Iris gen4 EU/UK black

## ARTWORK

Master Ref:	<b>PHL464774</b>
TR Ref:	<b>TR2145372</b>
Brand:	PHILIPS
Brand execution:	Moodlighting
Product name:	
Article Number:	N/A
Region:	Trident UK
Template Ref:	As Previous
Artwork Ref:	442294742402
Die cut 12NC:	
Barcode:	N/A
CRC Number:	
Action:	<b>C</b>
Date:	25/05/2021

Project Manager: Margarita Papoutsis

Trident Artist: Samantha Reilly

Technical & Non Printing Items  
■ Dieline ■ Guides

Colours:

Black	1
	3th

# PHILIPS



Please note that any low resolution paper Canon colour copies associated with this job should be referred to for content, layout and colour separation only.

UNDER NO CIRCUMSTANCES SHOULD THIS ARTWORK BE ALTERED WITHOUT PRIOR PERMISSION FROM TRIDENT.