

# EINBAUANLEITUNG

## Verbindungselement Mülltonnenbox "Alex"®

- Ⓜ GB Assembly instructions for the Dustbin Box "Alex"® connecting element
- Ⓜ FR Notice de montage de l'élément de liaison du range poubelle "Alex"®
- Ⓜ NL Opbouwbeschrijving verbindingselement voor de Container'Box "Alex"®
- Ⓜ ES Instrucciones de montaje del elemento de conexión del contenedor de basura "Alex"®
- Ⓜ IT Istruzioni di montaggio elemento di collegamento per il contenitore per rifiuti "Alex"®
- Ⓜ DK Montagevejledning samlemodule til affaldsbeholder box „Alex“®

For additional languages please go to: [www.biohort.com/downloads](http://www.biohort.com/downloads)





## Wichtige Punkte für den Aufbau!

Vorliegende Aufbauanleitung zeigt den Zusammenbau vom Verbindungselement Mülltonnenbox „Alex®“. Für einige Montageschritte benötigen Sie einen Helfer.

- (GB) *Important details regarding assembly! These assembly instructions show the assembly of the Dustbin Box "Alex®" connecting element. For some installation steps, a helper is needed.*
- (FR) *Points importants lors du montage! Cette instructions de montage montrent le montage de l'élément de liaison du range poubelle "Alex®". Pour certaines étapes d'installation vous avez besoin d'une aide.*
- (NL) *Deze opbouwbeschrijving toont de montage van het verbindingselement voor de ContainerBox "Alex®". Voor sommige Montageschappen heeft u een 2e persoon nodig.*
- (ES) *Estas instrucciones de montaje muestran el ensamblaje del elemento de conexión para los contenedores de basura "Alex®". Para algunos pasos de la instalación es necesario un ayudante.*
- (IT) *Queste istruzioni di montaggio mostrano il montaggio dell'elemento di collegamento "Alex®" del cassonetto per rifiuti. Per alcuni fasi di installazione è necessario un aiutante.*
- (DK) *Denne montagevejledning viser montage af samlemodul til affaldsbeholder box „Alex®“. Enkelte dele af montagen vil kræve 2 personer.*



## Um Kratzer zu vermeiden, verwenden Sie bitte geeignete Unterlagen!

- (GB) *Please use a suitable underlay to avoid scratches!*
- (FR) *Pour éviter les rayures, utilisez les supports appropriés!*
- (NL) *Om krassen te voorkomen raden wij u aan er iets onder te leggen!*
- (ES) *Por favor, coloque en el suelo una base protectora adecuada para evitar posibles arañazos.*
- (IT) *Utilizzare una base adatta per evitare graffi!*
- (DK) *Benyt venligst et passende underlag for at undgå skrammer!*



## Schraubverbindungen grundsätzlich erst am Ende der Montage festziehen!

- (GB) *Nuts not to be tightened before the end of assembly!*
- (FR) *Ne serrer les écrous à fond qu'à la fin du montage!*
- (NL) *Schroeven pas aan het einde van de montage vastdraaien!*
- (ES) *En principio, no apriete fijamente las tuercas hasta que no haya terminado de montar la caseta.*
- (IT) *I dadi devono essere serrati a fondo soltanto alla fine del montaggio!*
- (DK) *Møtrikkerne må ikke strammes før slutningen af opsætningen!*

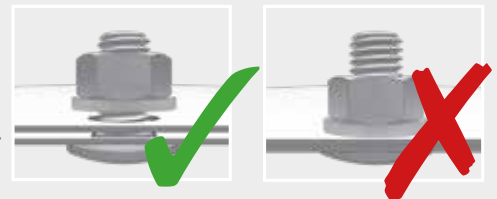

## Achten Sie auf eine sturmsichere Bodenverankerung und verriegeln Sie Türen/Deckel! Nicht bei Wind aufbauen!

- (GB) *Please make sure the product is anchored in a storm-proof manner and lock the doors/lid! Do not assembly in windy condition!*
- (FR) *Veillez à ce que le sol soit ancré de manière à résister aux tempêtes et verrouillez les portes/couvercles ! Ne pas procéder au montage dans des conditions venteuses !*
- (NL) *Zorg voor een stormbestendige bodem verankerung in vergrendel de deuren/deksel! Niet opbouwen in winderige omstandigheden!*
- (ES) *Asegúrese de que el suelo cuente con un anclaje a prueba de tormentas y cierre las puertas/tapas. ¡No se instalen en condiciones de viento!*
- (IT) *Assicuratevi che il pavimento sia ancorato a prova di tempesta e chiudete a chiave le porte/coperchio! Non montare in condizioni di vento!*
- (DK) *Vær opmærksom på at produktet forankres stormsikkert samt at dør/låg er aflåst! Bør ikke monteres ved kraftig vind!*



## Verwenden Sie bei der Montage Arbeitshandschuhe!

- (GB) *Wear working gloves!*
- (FR) *Portez des gants de travail*
- (NL) *Handschoenen gebruiken!*
- (ES) *Utilice unos guantes de trabajo.*
- (IT) *Utilizzare guanti da lavoro*
- (DK) *Brug arbejdshandsker!*



## Wasserwaagen - Symbol:

Betreffendes Einbauteil mit der Wasserwaage ausrichten.

- (GB) *Symbol of spirit level: Align the respective parts by using the spirit level.*
- (FR) *Symbole niveau à bulle: Lorsque ce symbole apparaît, vous devez ajuster l'élément à l'aide d'un niveau à bulle.*
- (NL) *Waterpas - symbol: Bij montageschappen waar dit symbool bijstaat is het noodzakelijk het betreffende onderdeel waterpas in te bouwen.*
- (ES) *Símbolo del nivelador: Indica que se debe ajustar y centrar la pieza con la ayuda de un nivelador.*
- (IT) *Simbolo di livella a bolla d'aria: Allineare il componente in questione con l'ausilio di una livella a bolla d'aria.*
- (DK) *Symbol for vaterpas: Juster de respektive dele ved hjælp af vaterpas.*

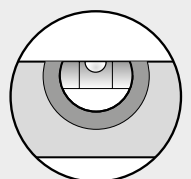



## ACHTUNG: Im Sommer können im Innenraum sehr hohe Temperaturen entstehen!

- (GB) Attention: during the summer high temperature might arise in the interior.
- (FR) Attention: En été la température à l'intérieur de l'abri peut être élevée!
- (NL) Let op: in de zomer kunnen in de berging zeer hoge temperaturen bereikt worden.
- (ES) Tenga en cuenta que en el verano las temperaturas en el interior pueden ser altas.
- (IT) Attenzione: Si prega di prendere nota che in estate si possono essere temperature molto elevate all'interno.
- (DK) Vigtigt: Der kan opstå meget høje temperaturer i skuret om sommeren.

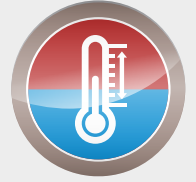

## Pflege und Wartung

- Keine aggressiven Chemikalien wie z.B. Chlor oder Streusalz lagern!
- Sonnenmilch und andere Cremes mit Wasser und Seife entfernen
- Keine scheuernden Reinigungsmittel verwenden!
- Tiefe Kratzer sofort mit beiliegendem Lack ausbessern!
- Ölen Sie das Schloss jährlich!

## (EN) Care and maintenance

- Do not store aggressive substances i.e. chlorine or road salt
- Remove suntan lotion or any other creams with water and rinse aid!
- Do not use abrasive cleaning agents!
- Touch-up scratches immediately with the paint provided.
- Lubricate the lock once a year!

## (FR) Entretien et maintenance

- Ne pas stocker de produits chimiques (chlore, sel, etc...)
- Nettoyez uniquement avec de l'eau les crèmes solaires et autres crèmes (pas de nettoyeur chimique).
- Corrigez immédiatement les rayures avec la laque jointe!
- Graissez la serrure et les charnières chaque année !

## (NL) Onderhoud

- Geen chemicaliën in de berging opslaan
- Zonnebrandolie/melk en andere cremes met water en zeep verwijderen
- Gebruik geen schuurmiddelen!
- Krassen direct met de meegeleverde lak behandelen
- Slot jaarlijks oliën

## (ES) Cuidado y mantenimiento

- No almacene productos químicos agresivos dentro de la caseta como por ejemplo cloro y sal antiescarcha.
- Evite dejar huellas o restos de cremas solares sobre la chapa. Limpie la caseta siempre con agua o un trapo húmedo.
- Repare los arañazos lo antes posible con el barniz que se incluye
- Aplique aceite en la cerradura y las bisagras una vez al año

## (IT) Manutenzione

- Non lasciare prodotti chimici aggressivi (come ad esempio cloro o sale per strade) all'interno della casetta!
- Rimuovere crema solare e altre creme con acqua e brillantante!
- Ritoccare immediatamente eventuali graffi con la vernice fornita nella confezione!
- Lubrificare la serratura e le cerniere a cadenza annuale!

## (DK) Pleje og vedligeholdelse

- Opbevar ikke aggressive stoffer dvs. Klor eller vejsalt!
- Fjern solcreme eller andre typer af creme med vand og rensmiddel!
- Brug ikke aggressive rengøringsmidler!
- Ved skrammer, brug straks malingen som er stillet til rådighed!
- Smør låsen årligt!

## Maßstabsgetreue Abbildungen der zu verwendenden Schrauben: M 1:1

- (GB) Scale drawing 1:1 of the screws in use
- (FR) Reproduction selon l'échelle 1:1.
- (NL) Afbeelding : schaal 1:1 (ware grootte)
- (ES) Reproducción a escala 1:1 de los tornillos que se utilizan para el montaje.
- (IT) Immagine in scala delle viti da utilizzare!
- (DK) Skala tegning af skruer er 1:1



4,8 x 13

M5 x 10



## ACHTUNG ATTENTION | ATTENTION | ATTENTIE | ATENCIÓN | ATTENZIONE | OBS.

Halten Sie während des Zusammenbaus alle mitgelieferten Kleinteile oder Verpackungsmaterialien fern von Kleinkindern. Bauteile weisen scharfe Kanten auf oder stehen vor, achten Sie während der Montage und bei der täglichen Nutzung darauf.



- GB Keep all supplied small parts or packaging materials away from small children during assembly. Components have sharp edges or protrude, pay attention to them during assembly and during daily use.
- FR Gardez toutes les petites pièces ou les matériaux d'emballage fournis hors de portée des enfants pendant le montage. Les pièces d'assemblage peuvent être tranchantes, faites-y attention lors de l'assemblage et de l'utilisation quotidienne.
- NL Houd alle kleine onderdelen of verpakkingsmaterialen die worden mee geleverd uit de buurt van kleine kinderen tijdens de montage. Onderdelen hebben scherpe randen of steken uit, let op bij de montage en bij het dagelijks gebruik.
- ES Mantenga todas las piezas pequeñas o materiales de embalaje suministrados lejos de los niños durante el montaje. Los componentes tienen bordes afilados o salientes, preste atención a ellos durante el montaje y durante el uso diario.
- IT Tenere tutte le piccole parti o i materiali d'imballaggio forniti lontano dalla portata dei bambini durante il montaggio. I componenti hanno spigoli vivi o sporgenti, prestare attenzione ad essi durante il montaggio e durante l'uso quotidiano.
- DK Hold alle leverede smådele og emballage utilgængeligt for børn under montagen. Komponenter har skarpe kanter eller stikker ud, vær opmærksom på dem under montering og under daglig brug.



### Schrauben mit Steckschlüssel festziehen!

- GB Tighten screws with nut driver!
- FR Serrez les vis à l'aide d'une clé à molette !
- NL Draai de schroeven vast met dopsleutel!
- ES Apretar los tornillos con una llave de vaso!
- IT Stringere le viti con la chiave a tubo!
- DK Skruer fastspændes med sekskant nøglen!



### Die zu montierenden Teile sind in den jeweiligen Aufbausritten gelb eingefärbt!

- GB The parts that need to be assembled are coloured in yellow in the respective construction step!
- FR Les pièces à monter sont colorées en jaune au cours des étapes de montage respectives!
- NL De te monteren onderdelen zijn in de betreffende bouwstappen geel gekleurd!
- ES Las piezas a montar son de color amarillo en los pasos de montaje correspondientes!
- IT Le parti da assemblare sono colorate in giallo nelle rispettive fasi di costruzione!
- DK De dele som skal monteres er markeret med gult!



### Orange eingefärbte Teile sind in den jeweiligen Aufbausritten zu demontieren!

- GB Parts coloured in orange need to be disassembled in the respective construction step!
- FR Les pièces de couleur orange doivent être démontées au cours des étapes de montage correspondantes!
- NL Oranje gekleurde onderdelen moeten in de desbetreffende bouwstappen losgeschroefd worden!
- ES Las piezas de color naranja deben desmontarse en los pasos de montaje correspondientes.
- IT Le parti di colore arancione devono essere smontate nelle rispettive fasi di assemblaggio!
- DK De dele som skal demonteres er markeret med orange!



**1.**

## Demontage Bauteile

Dismantling part - Démonter le ressort à gaz

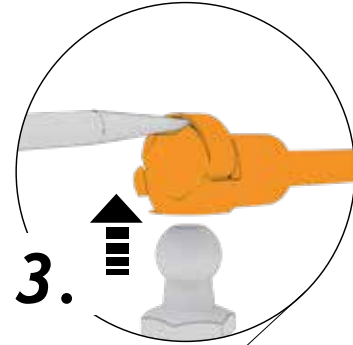

**2.**

## Demontage Bauteile

Dismantling part - Démonter le ressort à gaz

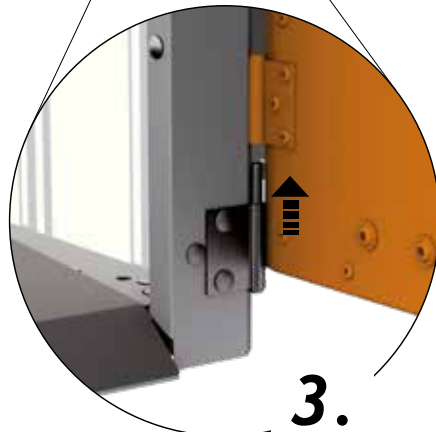

**3.**

### Demontage Bauteile

Dismantling part - Démonter le ressort à gaz

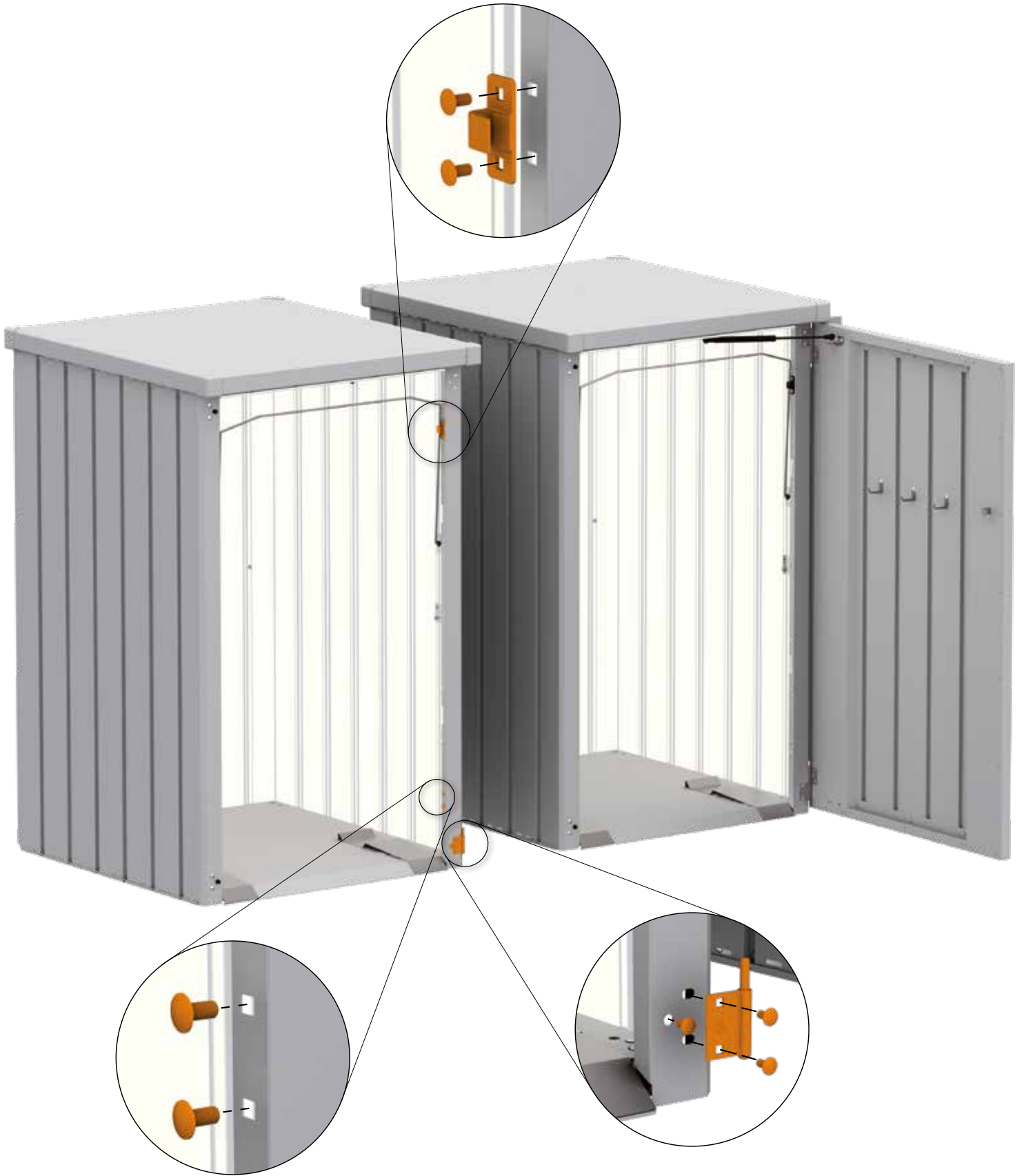

# 4.

## Demontage Bauteile

Dismantling part - Démonter le ressort à gaz

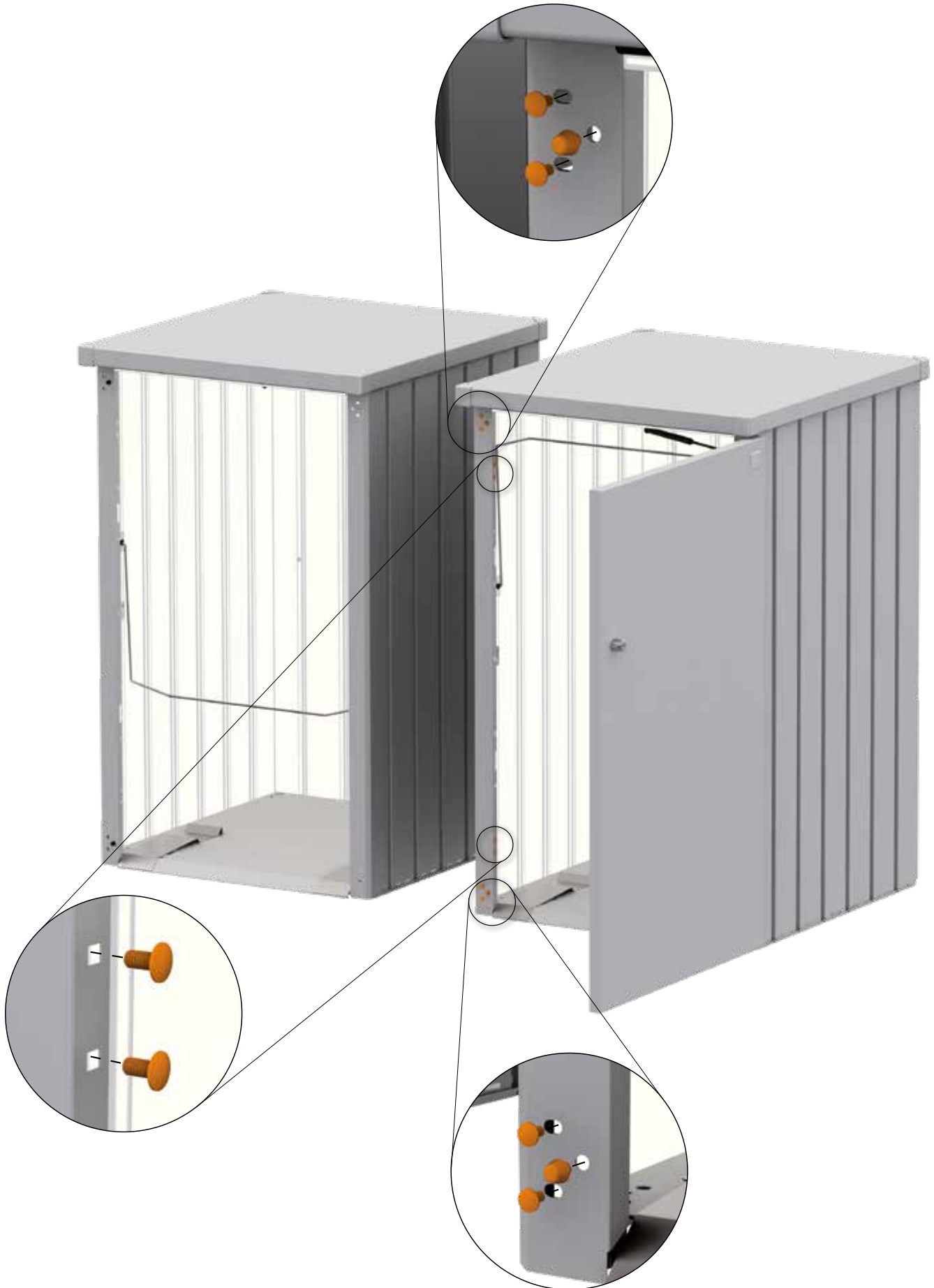



# 5.

## Demontage Bauteile

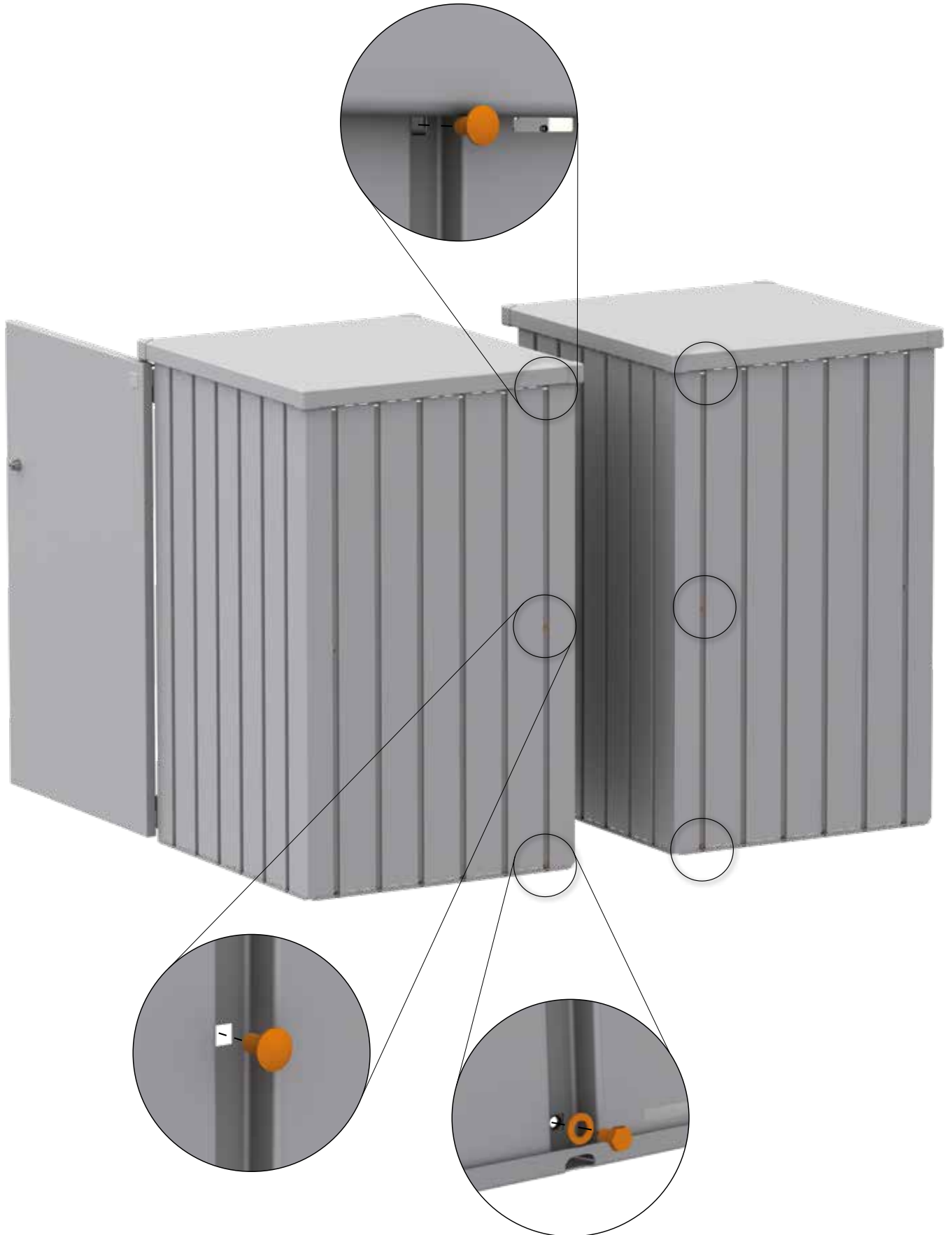

Dismantling part - Démonter le ressort à gaz

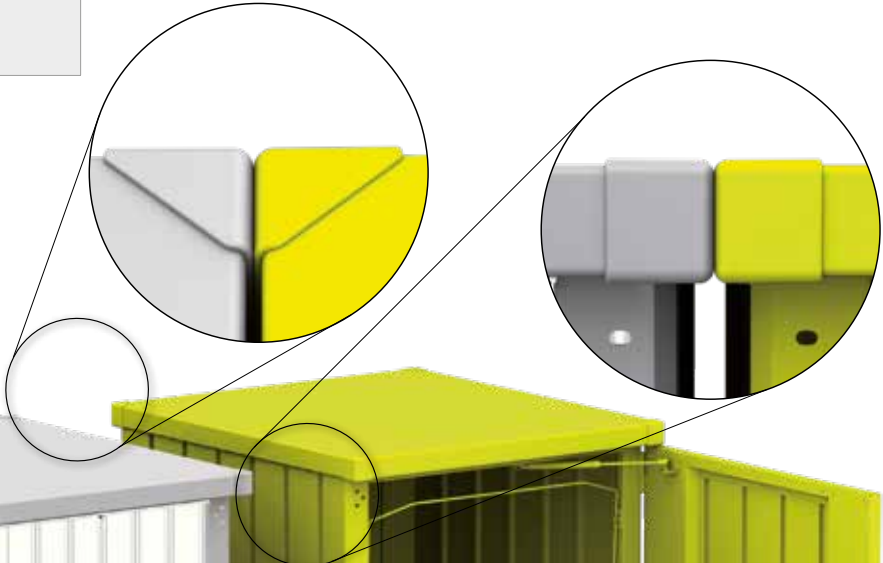
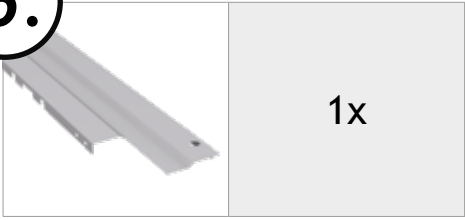

6.



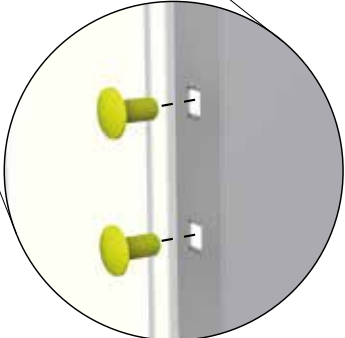
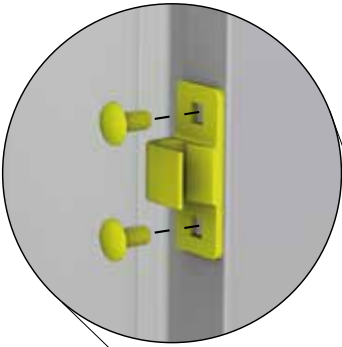

7.

	1x	M5 x 10 	4x
---	----	--	----



8.

	2x	M5 x 10 	4x
---	----	--	----



9.

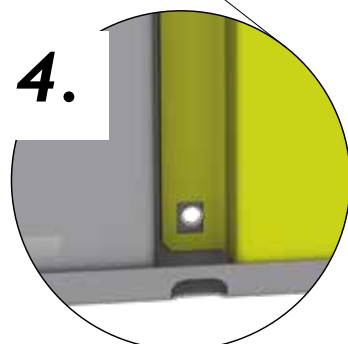
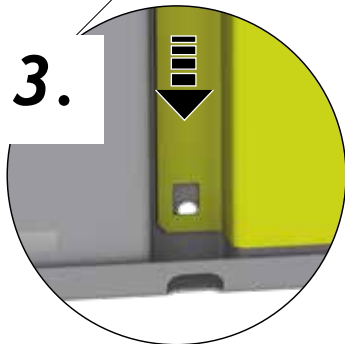
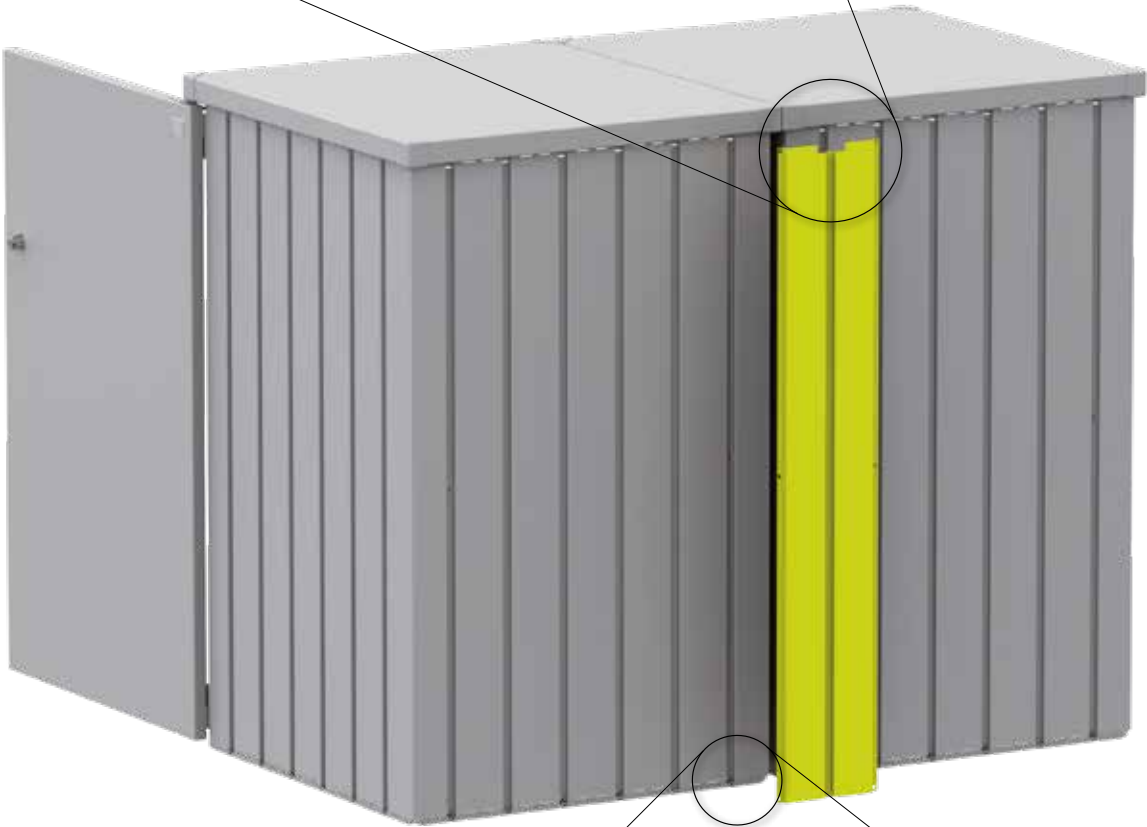
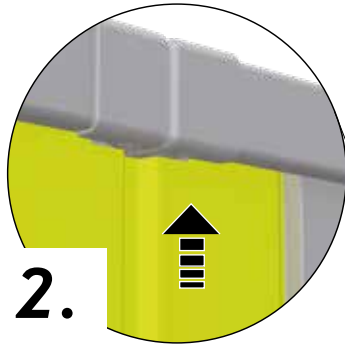
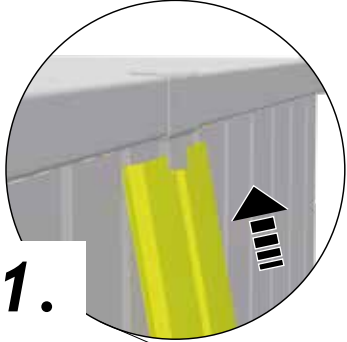
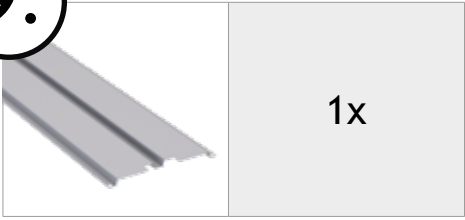

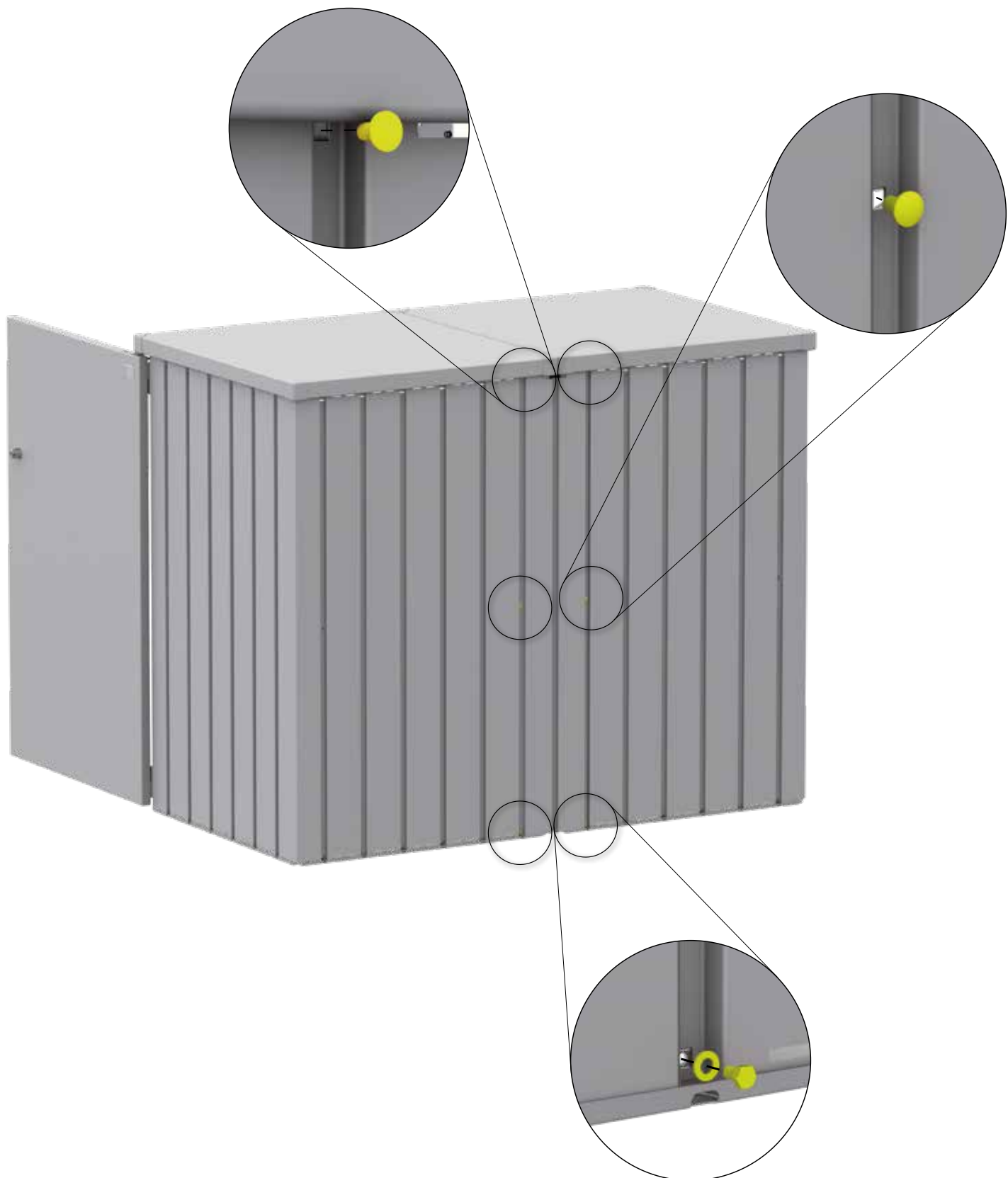

10.

M5 x 10 	4x	4,8 x 13 	2x
--	----	---	----



**11.**

	1x	M5 x 10		3x
---	----	---------	---	----

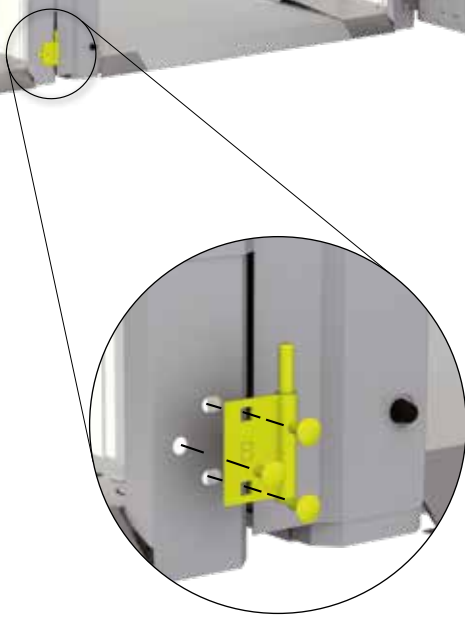

12.

	1x		1x	M5 x 10 	3x
---	----	--	----	---	----

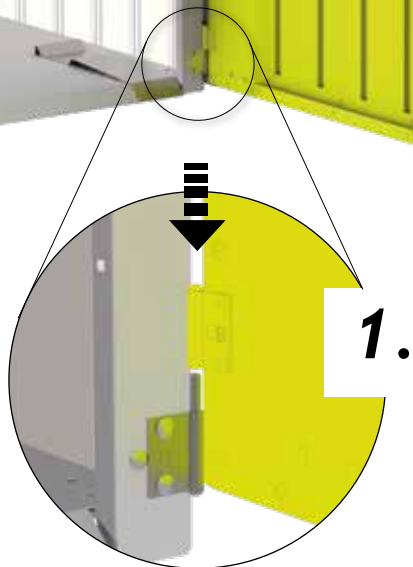
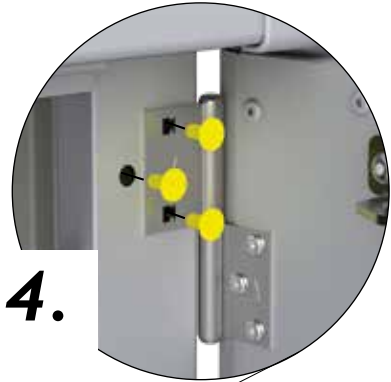
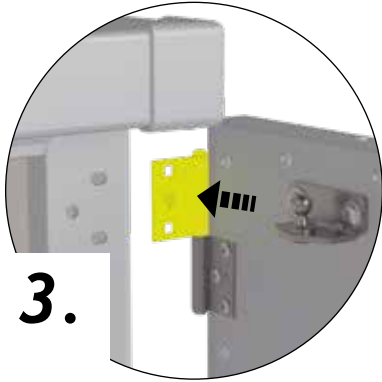
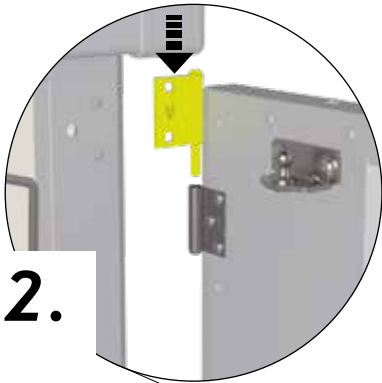



13.

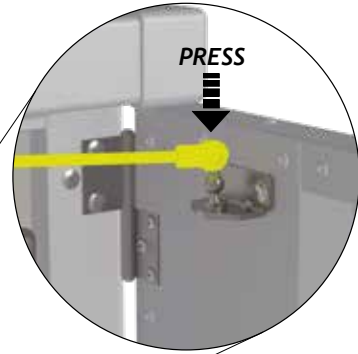
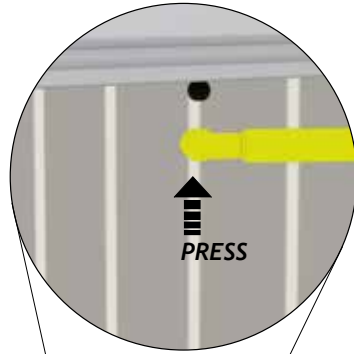
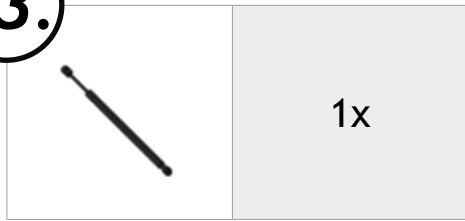

**14.****Ziehen Sie jetzt alle Schraubverbindungen fest an!**

Tighten now all nuts and connections securely! - Serrez maintenant les vis à fond! - Draai nu alle schroeven vast! - Ahora puede apretar y fijar todos los tornillos y tuercas - Adesso serrare a fondo tutti i dadi - Fastspænd nu alle bolt-/skruerforbindelser!

**1. Rechtwinkelig einrichten**



- Ⓒ rectangular adjusted
- Ⓕ ajuster en forme rectangulaire
- Ⓖ rechthoekig instellen
- Ⓔ ajustar en forma rectangular
- Ⓙ mettere in forma rettangolare
- Ⓚ indstil vinkelret

**2. Tür einrichten**

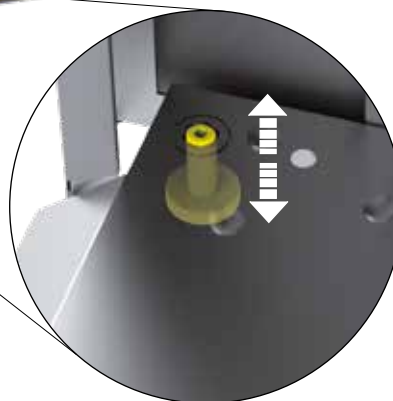
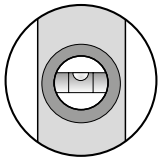
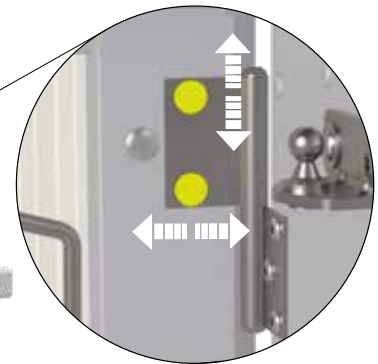
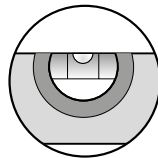
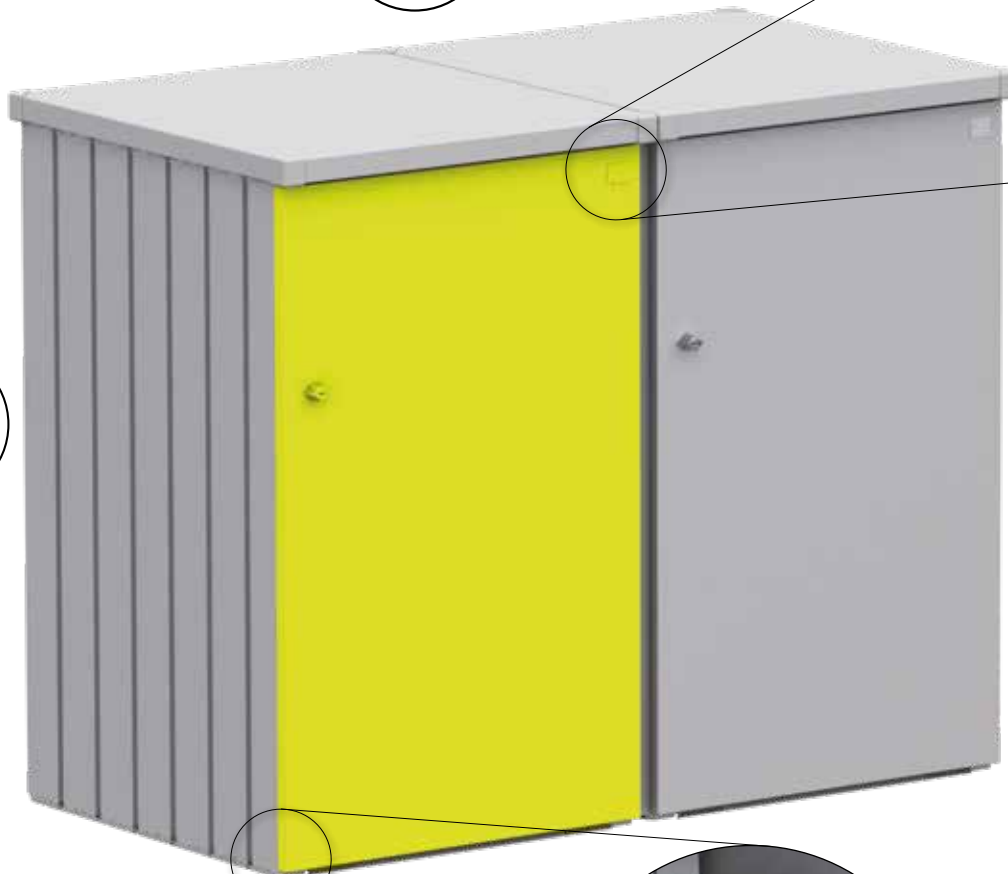
- Ⓒ align the door
- Ⓕ ajuster la porte
- Ⓖ deur afstellen
- Ⓔ ajuste la puerta
- Ⓙ aggiustare la porta
- Ⓚ justering af dør

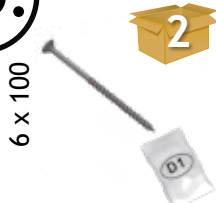

15.

 <p>6 x 100</p>	4x		4x		5x
--	----	---	----	---	----

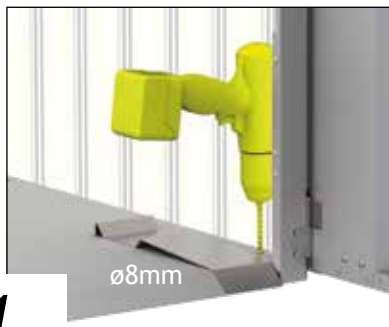
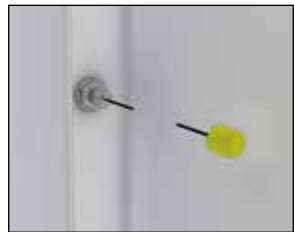

1.

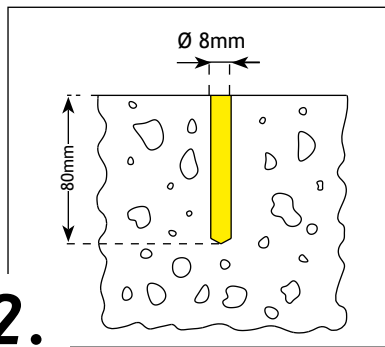

2.

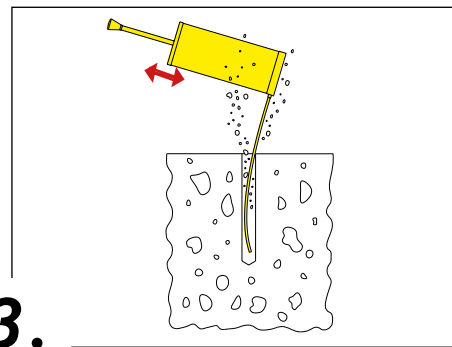

3.

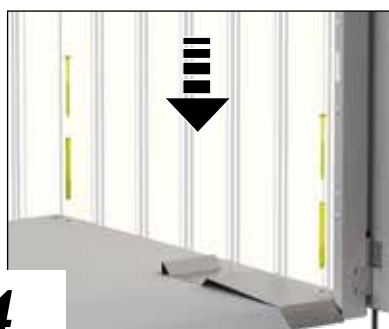

4.



5.

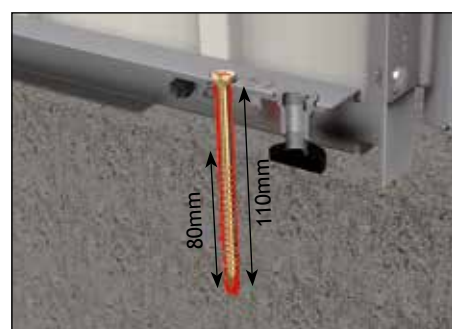



**GERÄTEHÄUSER** – Setzen Sie auf Qualität & Langlebigkeit  
**GARDEN SHEDS** – rely on quality & longevity



**GARTENBOXEN** – Outdoorboxen für Garten, Terrasse & Co.  
**OUTDOOR BOXES** – outdoor boxes for garden, patio & more



**FAHRRAD-GARAGEN** – Fahrräder, Roller & Co sicher verstaut  
**BICYCLE STORAGE** – for safe storage of bicycles, scooters & more



**MÜLLTONNEN-BOXEN** – Stylish, praktisch & wartungsfrei  
**DUSTBIN STORAGE** – stylish, practical & maintenance free



**GARTEN-HELFER** – Gartendesign in Bestform  
**GARDENING HELPERS** – garden design at its best

Kontrollnummer:  
 Control-number / Contrôle-Qualité / Controlnummer:



Bei Reklamationen bitte anführen:  
 Kontrollnummer und Artikelnummer des reklamierten Teils.

GB: In case of complaint please indicate the control-number and the number of the item, which is subject of complaint.

F: Pour toutes réclamations: prière de joindre le numéro de contrôle et le numéro d'article de la pièce litigieuse.

NL: Bij reclamaties svp doorgeven: controlnummer en artikelnummer van het desbetreffende onderdeel.



Biohort steht für  
 „LEBEN IM GARTEN“

Biohort stands for  
 „LIFE IN THE GARDEN“

follow us:

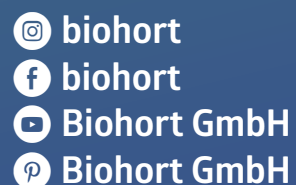

**Biohort GmbH**  
 Pürnstein 43, 4120 Neufelden, Österreich  
 Tel: +43-7282-7788-0, Fax-DW: 190  
 E-Mail: office@biohort.at, www.biohort.com