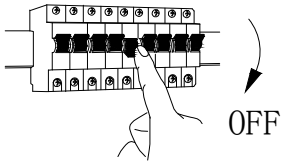
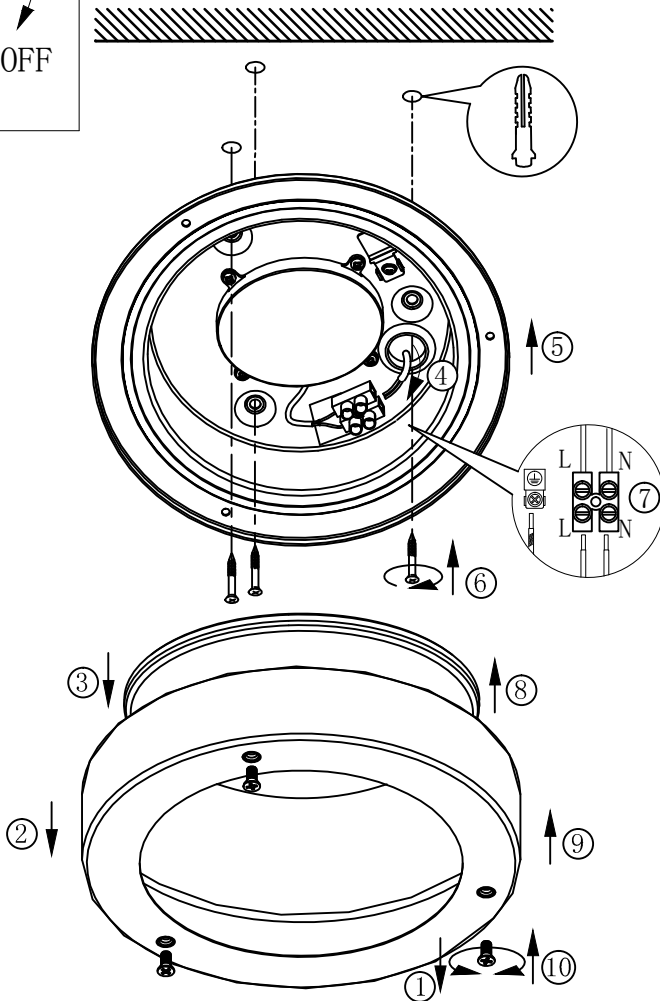
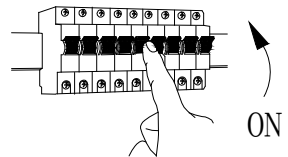

A**B****C**

BLA96365
www.eglo.com