

1915-1

08/21

- Montageanleitung
- Assembly instructions
- Notice de montage
- Montagehandleiding
- Návod na montáž
- Instrucțiune de montaj
- Navodila za namestitev
- Installationstruktioener

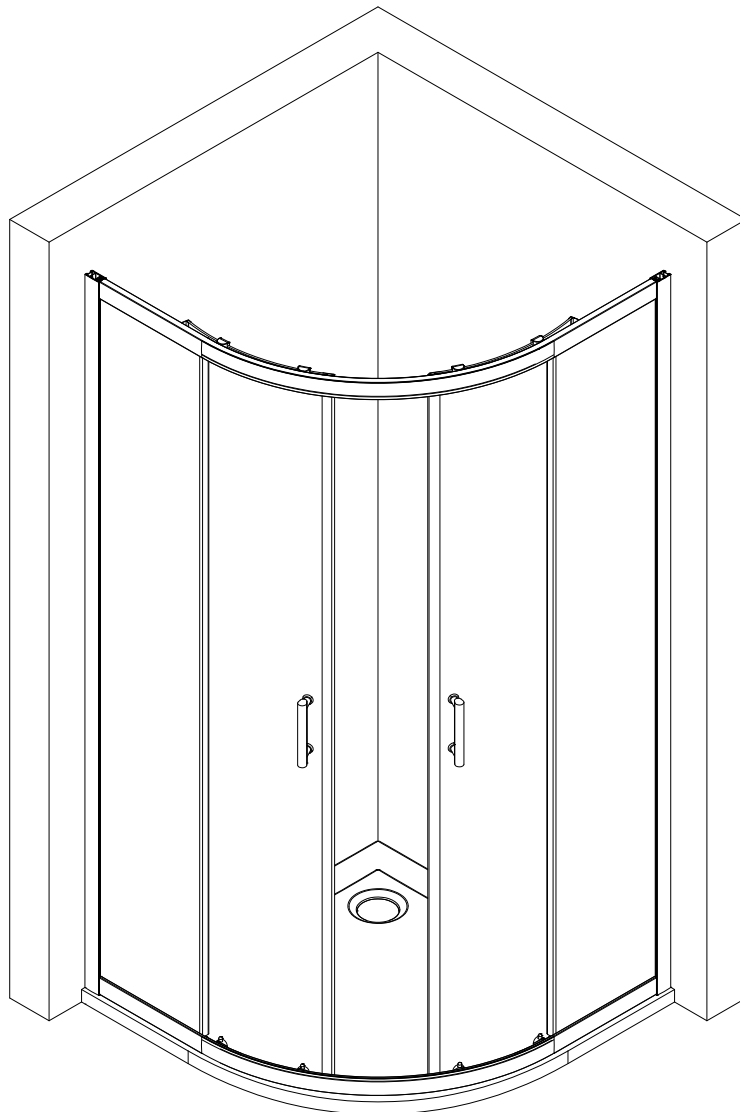

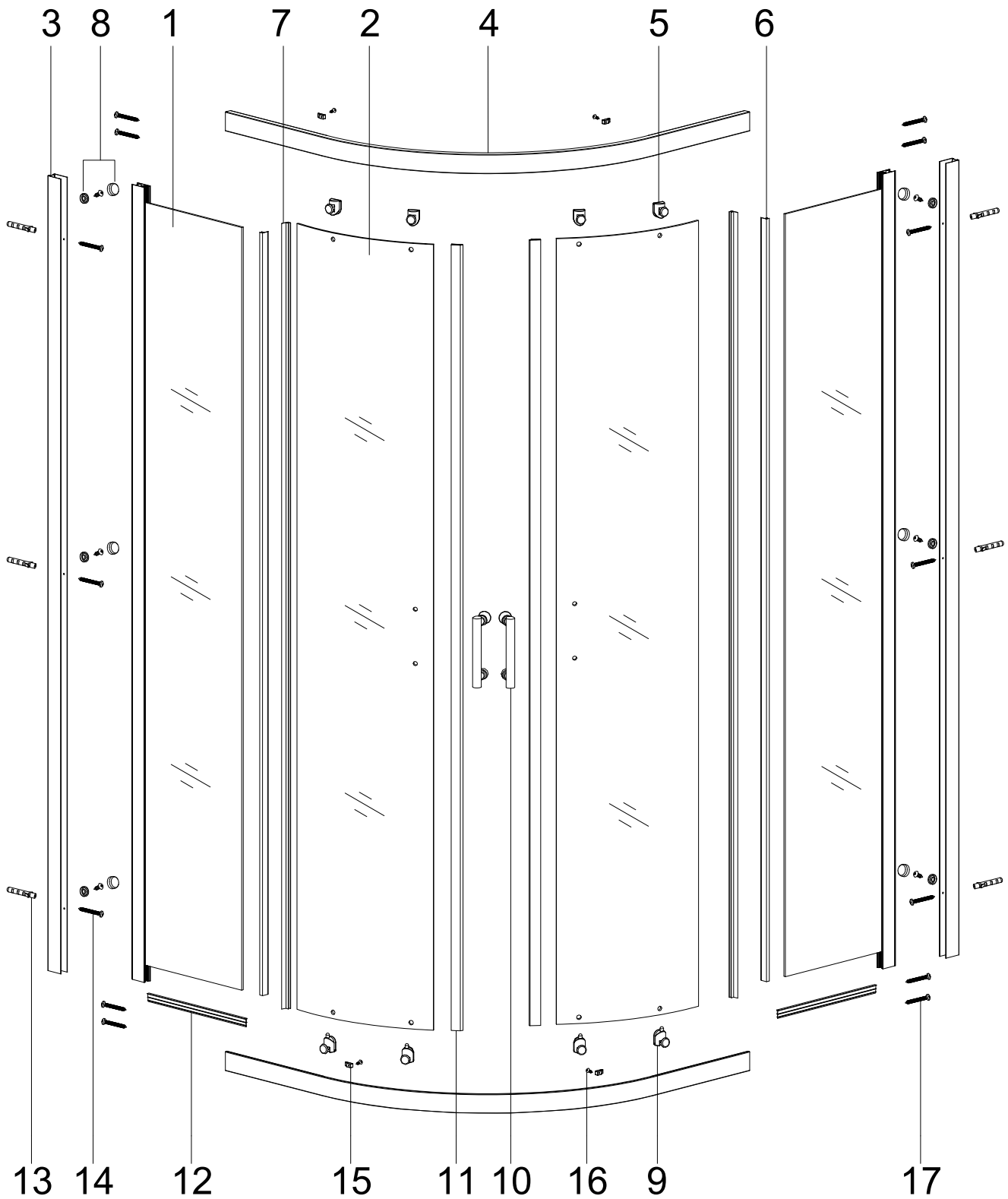

Pos.	Bezeichnung	Ersatzteil-Nr.	Preis	Pos.	Bezeichnung	Ersatzteil-Nr.	Preis
1.1	1x Festelement rechts			9	4x Rollenwagen unten	E36280-3	Set 22,95 €
1.2	1x Festelement links			10	2x Stangengriff	E100140-94	Stück 32,95 €
2.1	1x Türelement rechts			11	2x Magnetprofil	E36056-3	Set 54,95 €
2.2	1x Türelement links			12	2x Dichtung horizontal	E36058-3	Set 24,95 €
3	2x Wandanschlussprofil	E36230-3	Stück 32,95 €	13	6x Dübel		
4	2x Rahmenober-/ unterprofil	E36242-3	Stück 36,95 €	14	6x Schraube Ø 3,9x30 mm		
5	4x Rollenwagen oben	E36263-3	Set 22,95 €	15	4x Klemmteil		
6	2x Vertikaldichtprofil	E36065-3	Stück 24,95 €	16	10x Schraube Ø 3,9x10 mm		
7	2x Vertikaldichtprofil	E36065-3	Stück 24,95 €	17	8x Schraube Ø 3,9x30 mm		
8	6x Unterlegling + Abdeckkappe für Kappenschraube						
					* Schrauben- und Abdeckkappenset	E36200-3	Set 16,95 €

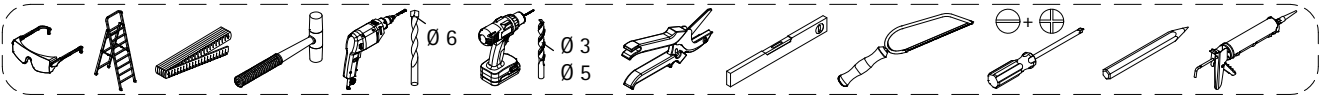

<p>1</p> <p>X2</p>	<p>2</p> <p>X2</p>	<p>3</p> <p>X2</p>	<p>4</p> <p>X2</p>
<p>5</p> <p>X4</p>	<p>6</p> <p>X2</p>	<p>7</p> <p>X2</p>	<p>8</p> <p>X6</p>
<p>9</p> <p>X4</p>	<p>10</p> <p>X2</p>	<p>11</p> <p>X1</p>	<p>12</p> <p>X2</p>
<p>13</p> <p>X6</p>	<p>14</p> <p>ST3.9X30 X6</p>	<p>15</p> <p>X4</p>	<p>16</p> <p>ST3.9X10 X10</p>
<p>17</p> <p>ST3.9X30 X8</p>			

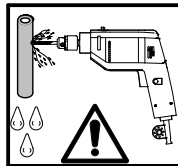
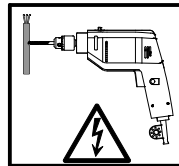
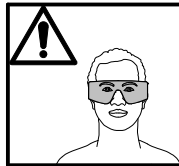
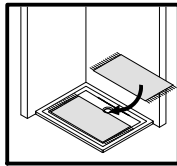
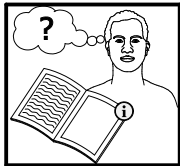

Pos. 3

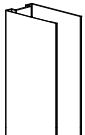

X2

Pos. 13



X6

Pos. 14



3,9 x 30 mm

X6

Pos. 3

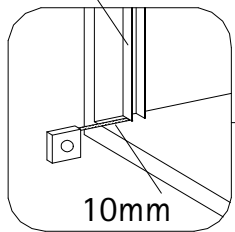

10mm

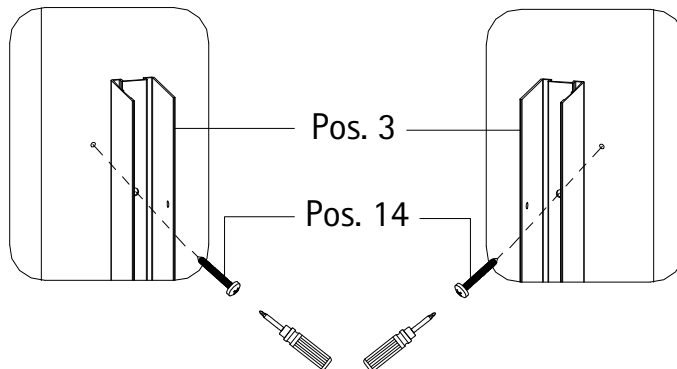
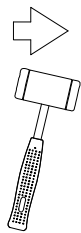
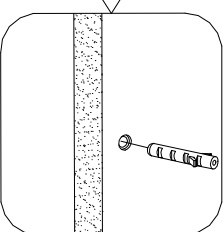
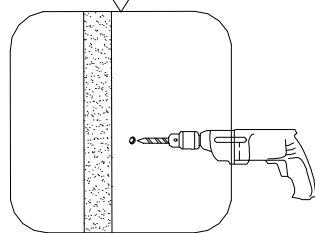
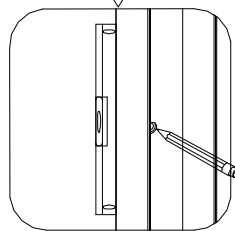

Pos. 3

Pos. 14

Pos. 3

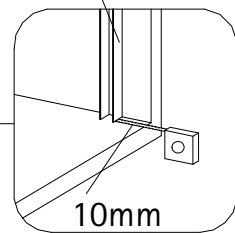

10mm

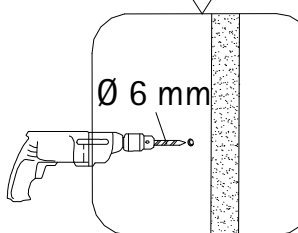
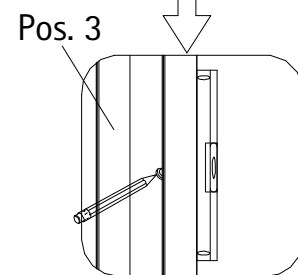

Ø 6 mm

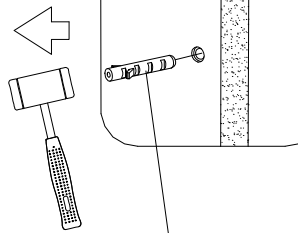

Pos. 13

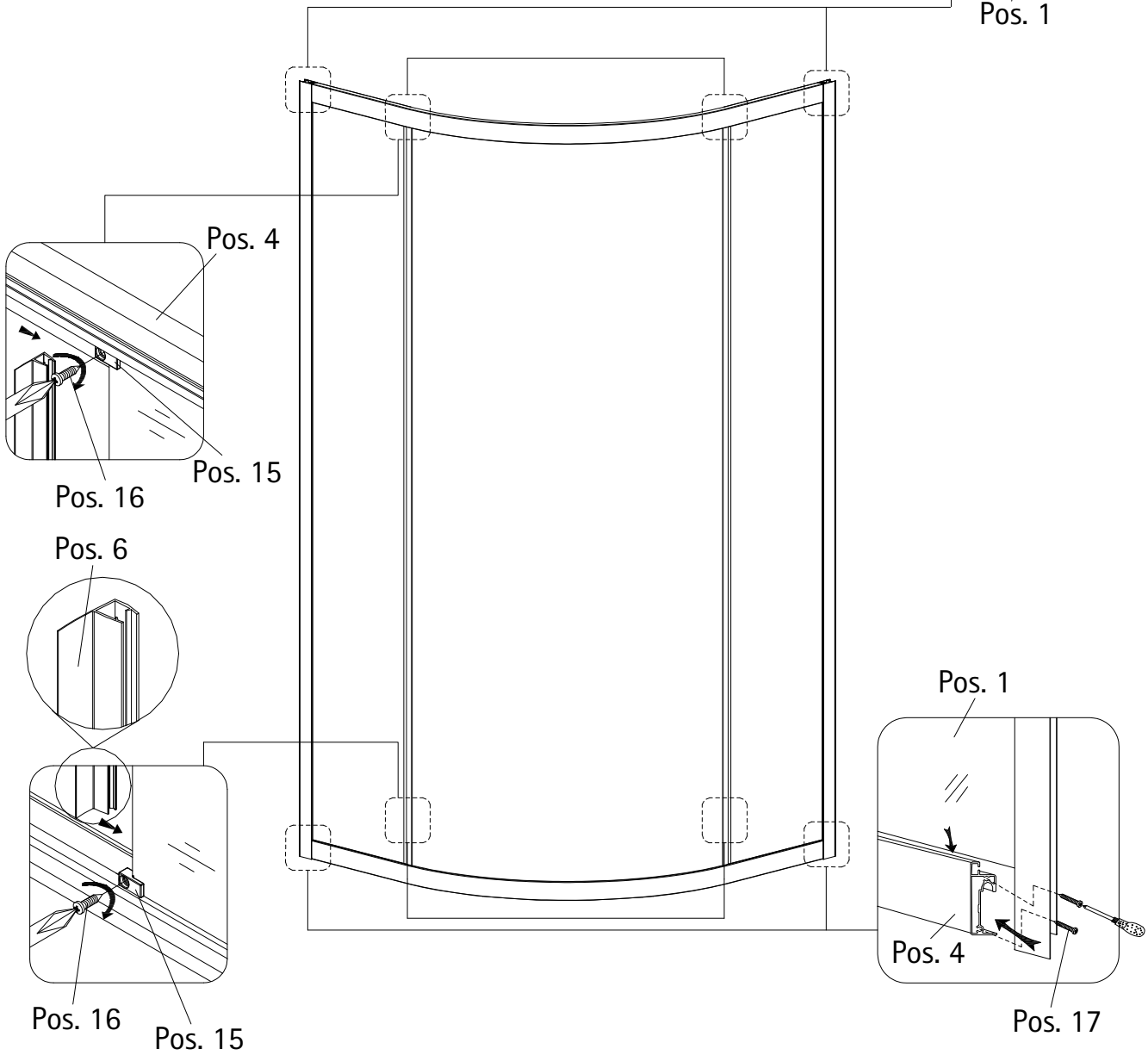
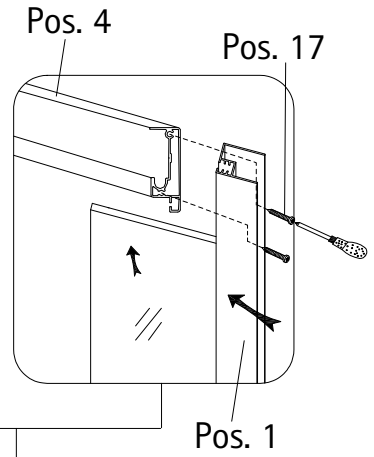
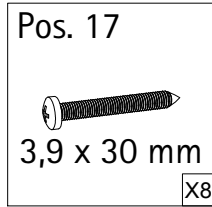
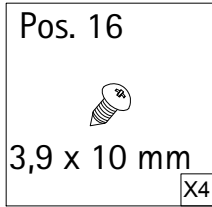
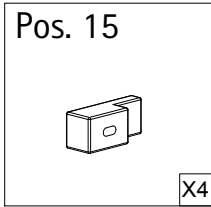
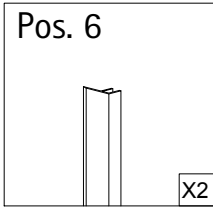
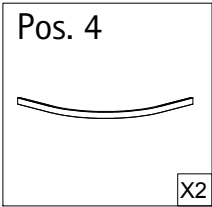
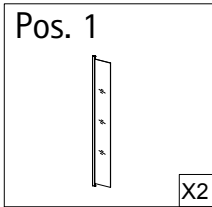

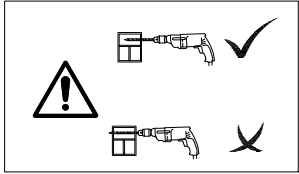
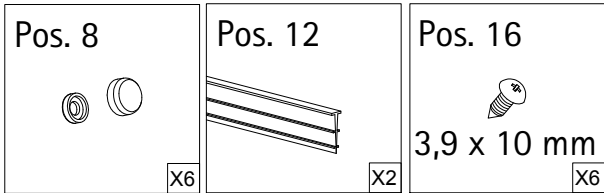

Pos. 3 Pos. 4

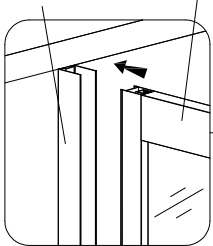

Pos. 1

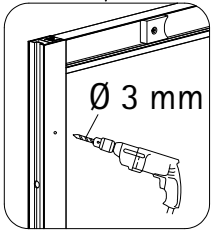

Pos. 8

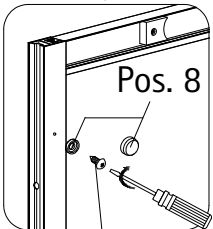

Pos. 16

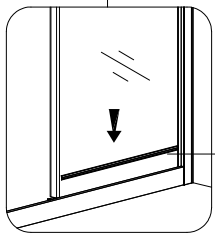
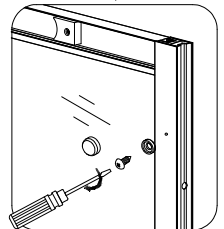
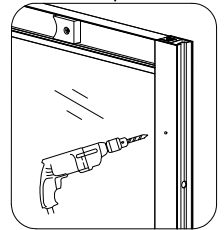
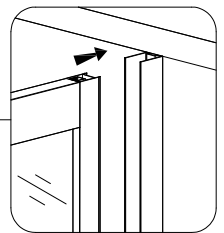
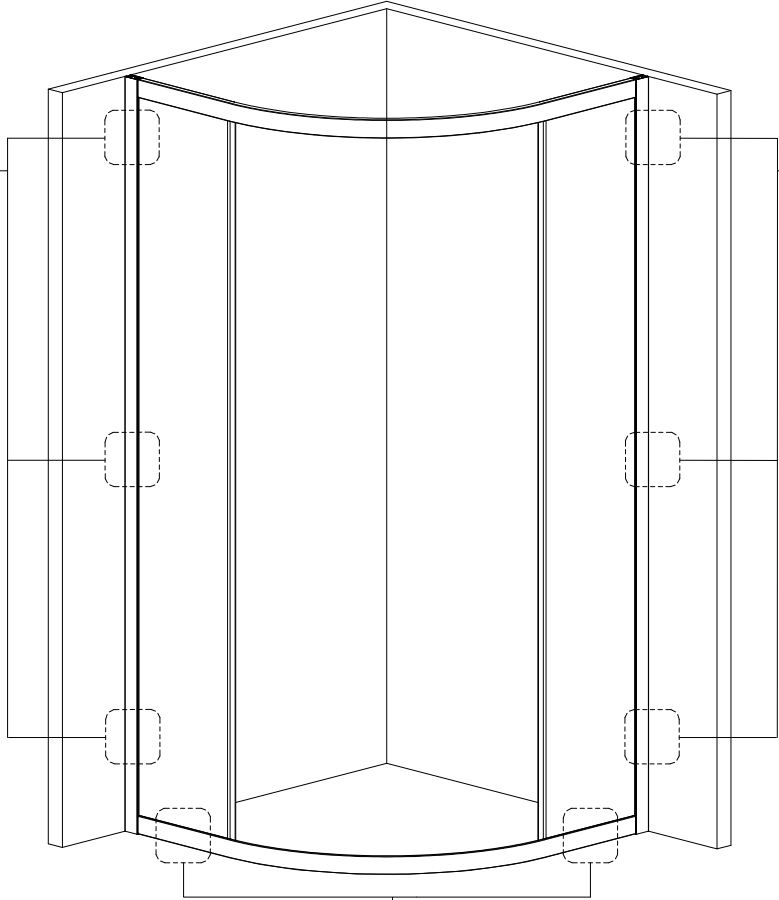

Pos. 12

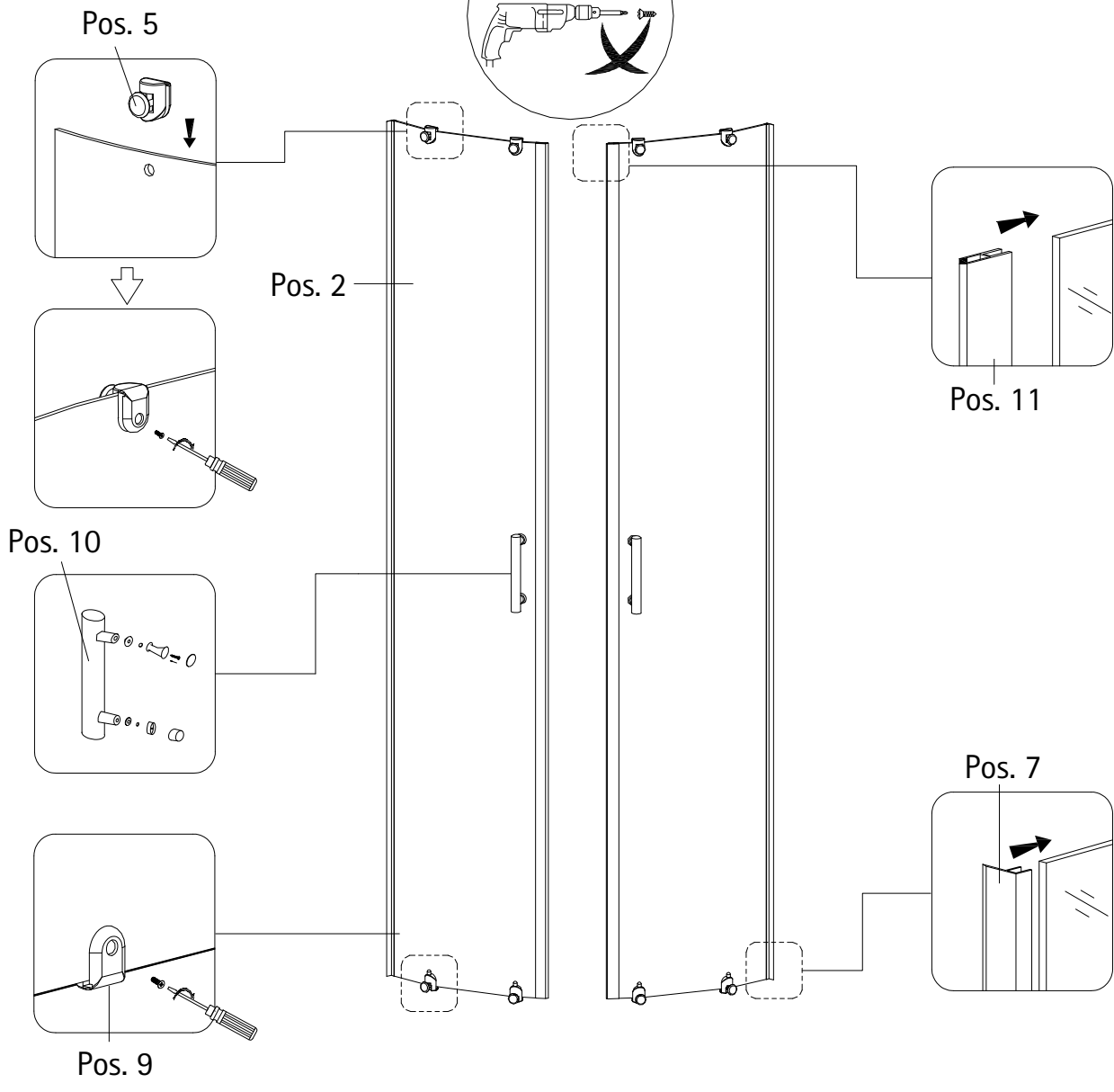
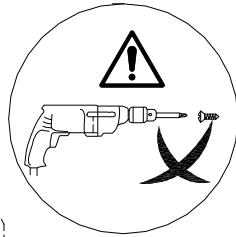
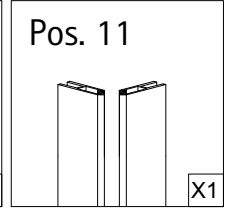
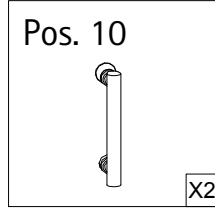
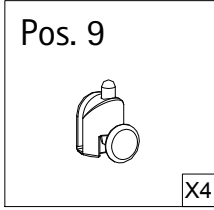
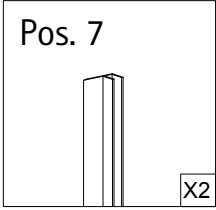
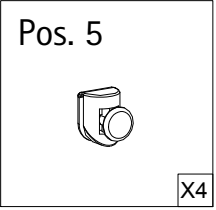
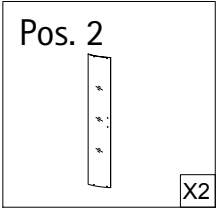

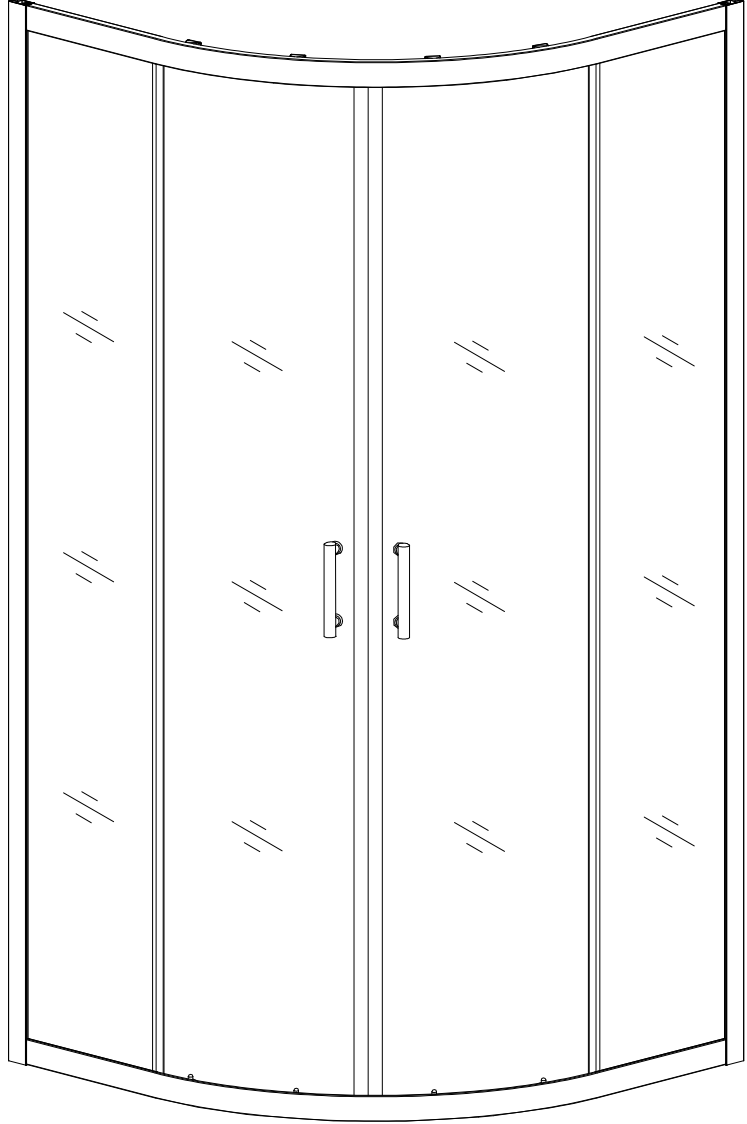
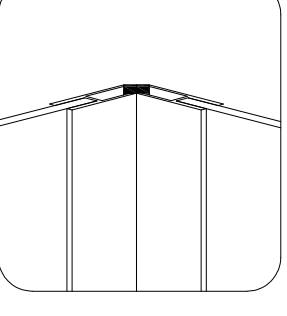
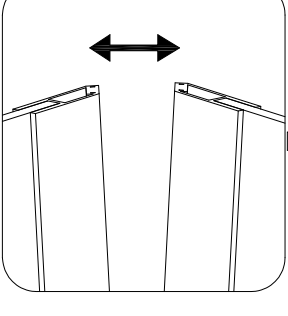
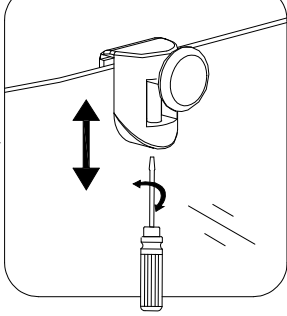
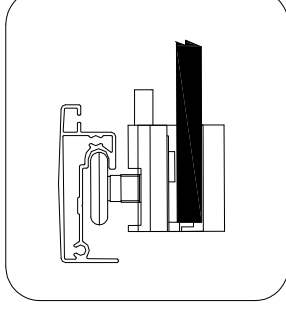
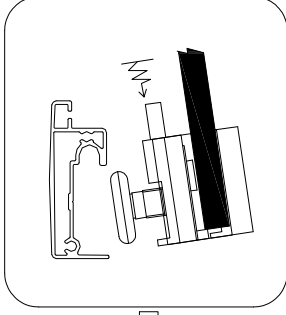
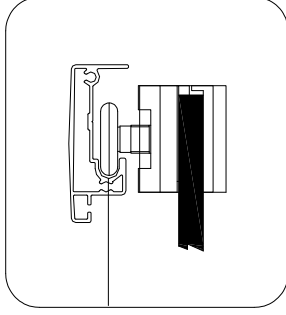
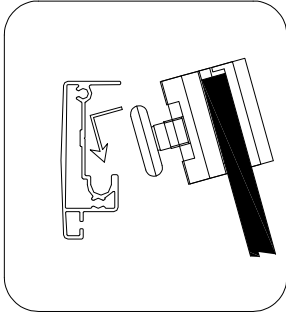

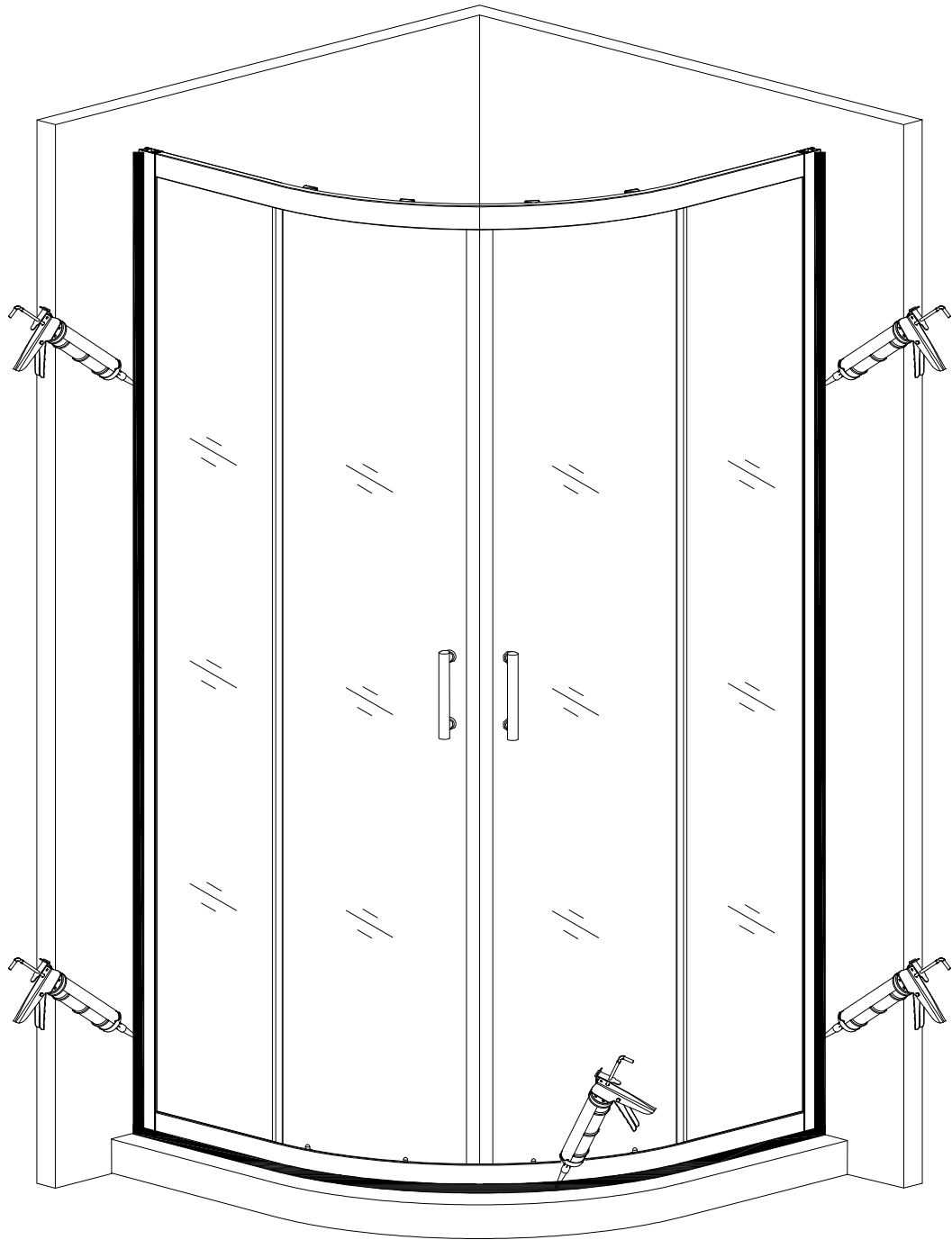

Notizen, notes, notities

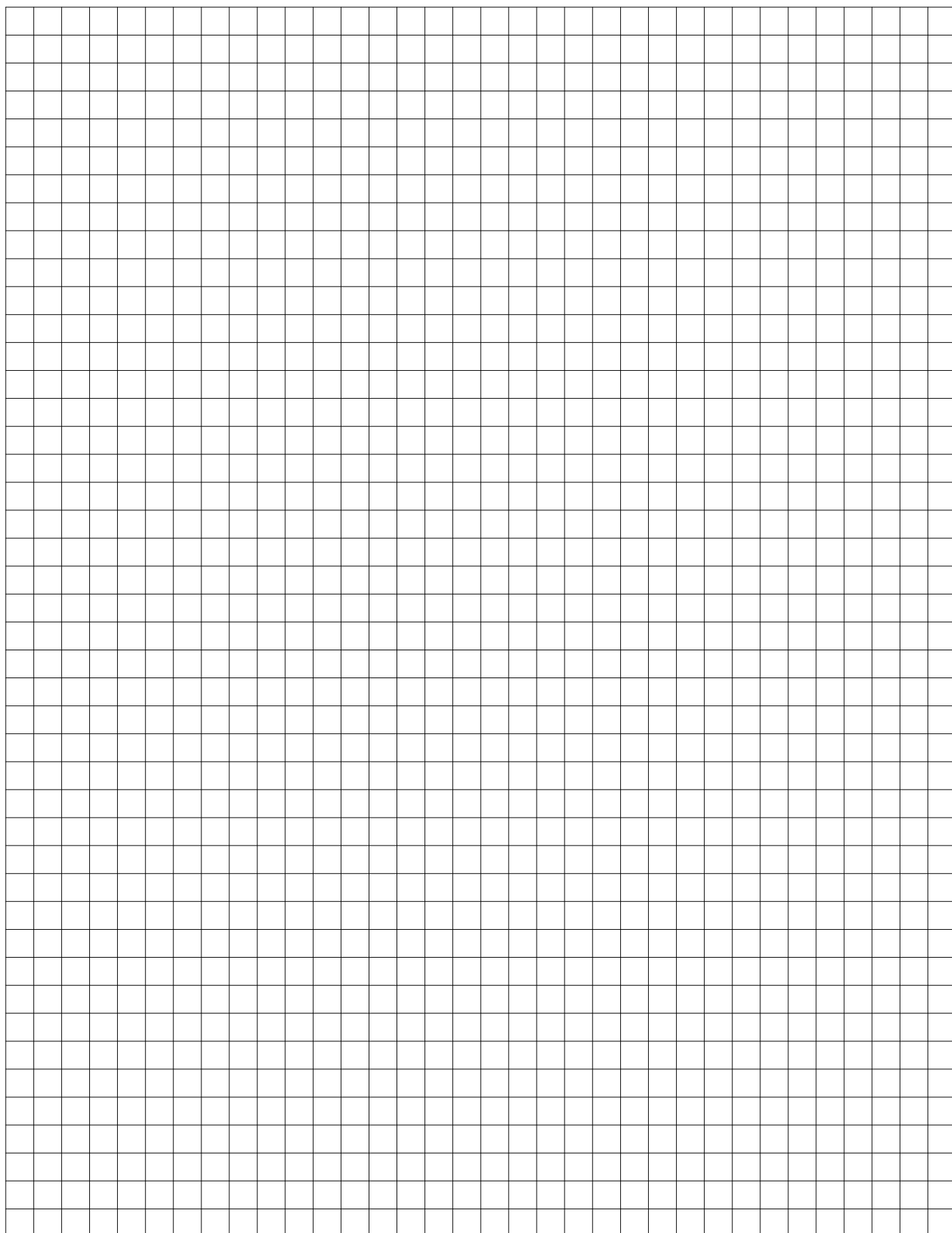

Notizen, notes, notities

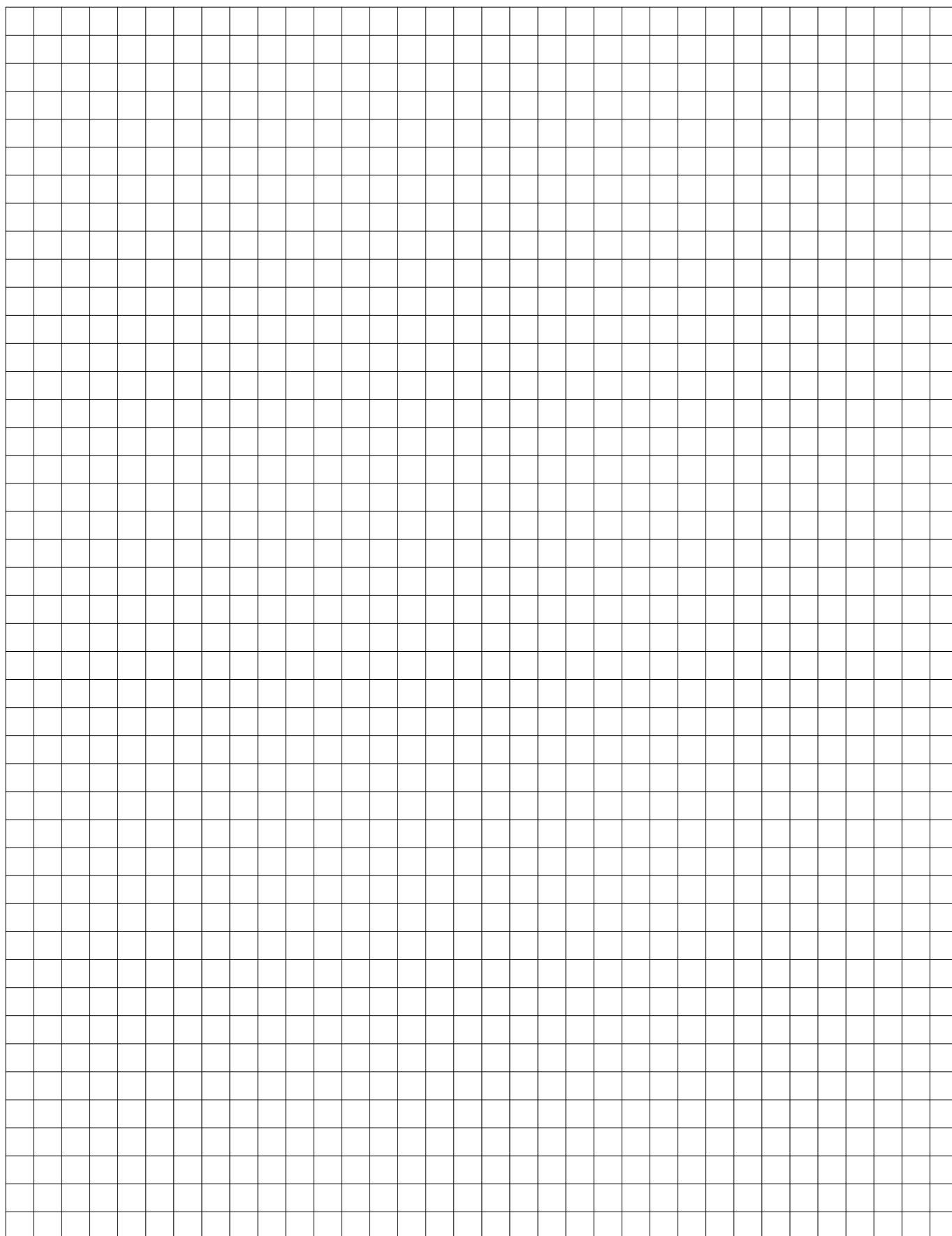

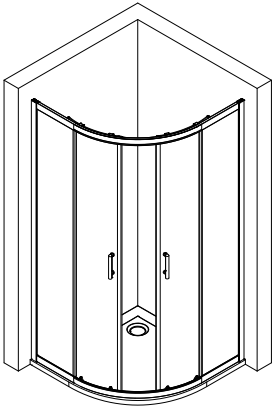

1915-1

Kontrollbeleg
Control Receipt
Justificatif de contrôle
Controle-attest

Prüfnummer/ Inspection number / Numéro d'essai / Controlnummer



Service
Am Lindhövel 1
59846 Sundern
Deutschland / Germany / Allemagne / Duitsland



Allgemeine technische Probleme:
Telefon 02935 / 96 53 444



E-Mail:
onlineservice@schulte.de