

ARTWORK

Master Ref: **PHL468405**
 TR Ref: **TR2164727**
 Brand: PHILIPS
 Brand execution: HUE White and Color Ambiance
 Product name: Gradient Lightstrip extension
 Shape: N/A
 Wattage: N/A
 Region: Trident UK
 Artwork 12NC: 3222 639 08581
 Die cut 12NC: DFX size
 Barcode: N/A
 CRC Number:
 Action: **C**
 Date: 13/07/2021

Project Manager: Margarita Papoutsis

Trident Artist: Michelle Hays

Technical & Non Printing Items

■ Dieline
 ■ Guides

Colours:

Process black	1
	2%

PHILIPS



TRIDENT

Trident UK, Connaught House, Connaught Road,
 Kingswood Business Park, Hull, HU7 3AP, England.
 T: +44 (0) 01482 828100

Please note that any low resolution paper Canon colour copies associated with this job should be referred to for content, layout and colour separation only.

UNDER NO CIRCUMSTANCES SHOULD THIS
 ARTWORK BE ALTERED WITHOUT PRIOR
 PERMISSION FROM TRIDENT.

ARTWORK

Master Ref: **PHL468405**
TR Ref: **TR2164727**
Brand: PHILIPS
Brand execution: HUE White and Color Ambiance
Product name: Gradient Lightstrip extension
Shape: N/A
Wattage: N/A
Region: Trident UK
Artwork 12NC: 3222 639 08581
Die cut 12NC: DFX size
Barcode: N/A
CRC Number:
Action: **C**
Date: 13/07/2021

Project Manager: Margarita Papoutsis

Trident Artist: Michelle Hays

Technical & Non Printing Items

■ Dieline ■ Guides

Colours:

Process black
1
3%

PHILIPS



TRIDENT
Trident UK, Connaught House, Connaught Road,
Kingswood Business Park, Hull, HU7 3AP, England.
T: +44 (0) 01482 828100

Please note that any low resolution paper Canon colour copies associated with this job should be referred to for content, layout and colour separation only.

UNDER NO CIRCUMSTANCES SHOULD THIS ARTWORK BE ALTERED WITHOUT PRIOR PERMISSION FROM TRIDENT.

100 mm

120 mm

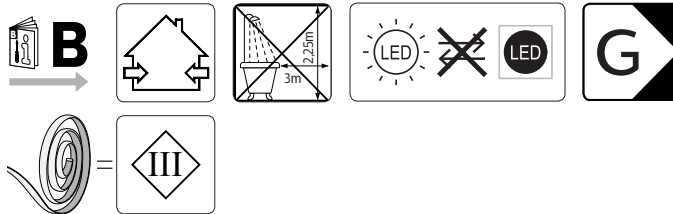
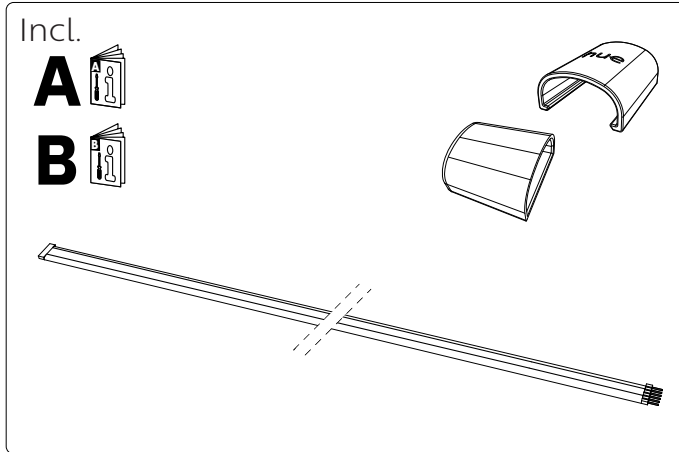

2

ARTWORK

Master Ref: **PHL468405**
TR Ref: **TR2164727**
Brand: PHILIPS
Brand execution: HUE White and Color Ambiance
Product name: Gradient Lightstrip extension
Shape: N/A
Wattage: N/A
Region: Trident UK
Artwork 12NC: 3222 639 08581
Die cut 12NC: DFX size
Barcode: N/A
CRC Number:
Action: **C**
Date: 13/07/2021

Project Manager: Margarita Papoutsis

Trident Artist: Michelle Hays

Technical & Non Printing Items

■ Dieline ■ Guides

Colours:

Process black	1
	1
	1

PHILIPS



TRIDENT

Trident UK, Connaught House, Connaught Road,
Kingswood Business Park, Hull, HU7 3AP, England.
T: +44 (0) 01482 828100

Please note that any low resolution paper Canon colour
copies associated with this job should be referred to for
content, layout and colour separation only.

UNDER NO CIRCUMSTANCES SHOULD THIS
ARTWORK BE ALTERED WITHOUT PRIOR
PERMISSION FROM TRIDENT.

100 mm

120 mm

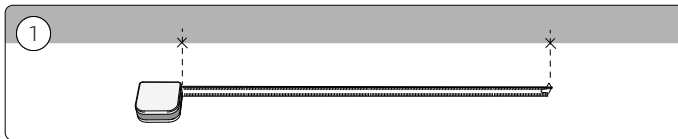
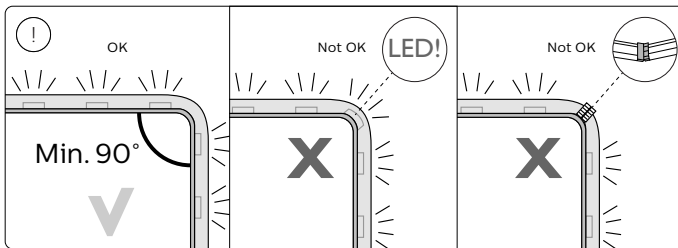
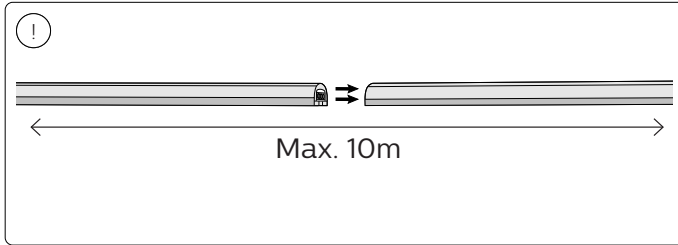

3

ARTWORK

Master Ref: **PHL468405**
TR Ref: **TR2164727**
Brand: PHILIPS
Brand execution: HUE White and Color Ambiance
Product name: Gradient Lightstrip extension
Shape: N/A
Wattage: N/A
Region: Trident UK
Artwork 12NC: 3222 639 08581
Die cut 12NC: DFX size
Barcode: N/A
CRC Number:
Action: **C**
Date: 13/07/2021

Project Manager: Margarita Papoutsis

Trident Artist: Michelle Hays

Technical & Non Printing Items

■ Dieline ■ Guides

Colours:

Process black	1
	3%

PHILIPS



TRIDENT

Trident UK, Connaught House, Connaught Road,
Kingswood Business Park, Hull, HU7 3AP, England.
T: +44 (0) 01482 828100

Please note that any low resolution paper Canon colour
copies associated with this job should be referred to for
content, layout and colour separation only.

UNDER NO CIRCUMSTANCES SHOULD THIS
ARTWORK BE ALTERED WITHOUT PRIOR
PERMISSION FROM TRIDENT.

100 mm

120 mm

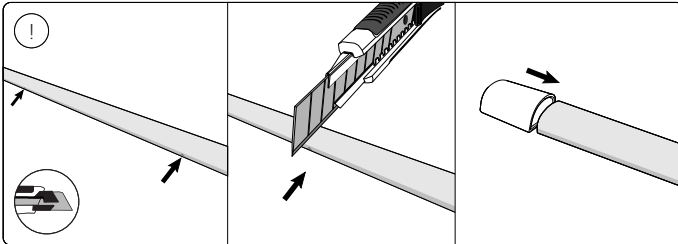
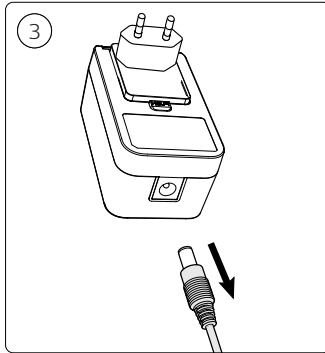
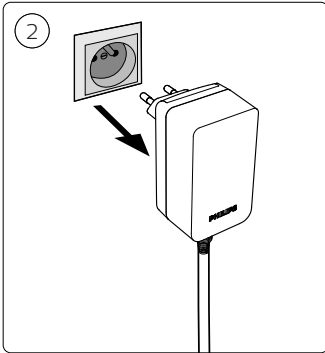

4

ARTWORK

Master Ref: **PHL468405**
TR Ref: **TR2164727**
Brand: PHILIPS
Brand execution: HUE White and Color Ambiance
Product name: Gradient Lightstrip extension
Shape: N/A
Wattage: N/A
Region: Trident UK
Artwork 12NC: 3222 639 08581
Die cut 12NC: DFX size
Barcode: N/A
CRC Number:
Action: **C**
Date: 13/07/2021

Project Manager: Margarita Papoutsis

Trident Artist: Michelle Hays

Technical & Non Printing Items

■ Dieline ■ Guides

Colours:

Process black	1
	1%
	5%

PHILIPS



TRIDENT

Trident UK, Connaught House, Connaught Road,
Kingswood Business Park, Hull, HU7 3AP, England.
T: +44 (0) 01482 828100

Please note that any low resolution paper Canon colour
copies associated with this job should be referred to for
content, layout and colour separation only.

UNDER NO CIRCUMSTANCES SHOULD THIS
ARTWORK BE ALTERED WITHOUT PRIOR
PERMISSION FROM TRIDENT.

100 mm

120 mm

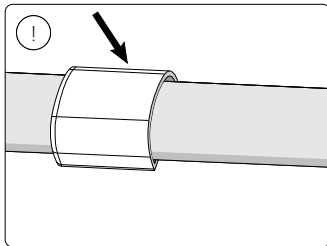
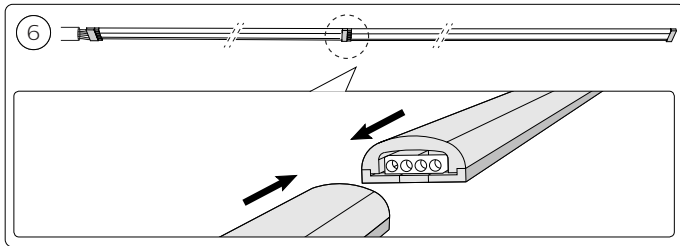
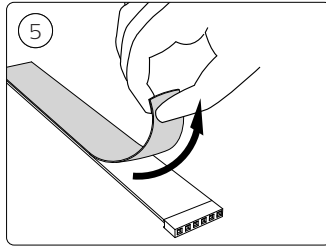
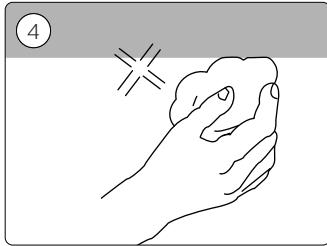

5

ARTWORK

Master Ref: **PHL468405**
TR Ref: **TR2164727**
Brand: PHILIPS
Brand execution: HUE White and Color Ambiance
Product name: Gradient Lightstrip extension
Shape: N/A
Wattage: N/A
Region: Trident UK
Artwork 12NC: 3222 639 08581
Die cut 12NC: DFX size
Barcode: N/A
CRC Number:
Action: **C**
Date: 13/07/2021

Project Manager: Margarita Papoutsis

Trident Artist: Michelle Hays

Technical & Non Printing Items

■ Dieline ■ Guides

Colours:

Process black	1
	1%
	5%

PHILIPS



TRIDENT

Trident UK, Connaught House, Connaught Road,
Kingswood Business Park, Hull, HU7 3AP, England.
T: +44 (0) 01482 828100

Please note that any low resolution paper Canon colour
copies associated with this job should be referred to for
content, layout and colour separation only.

UNDER NO CIRCUMSTANCES SHOULD THIS
ARTWORK BE ALTERED WITHOUT PRIOR
PERMISSION FROM TRIDENT.

100 mm

120 mm

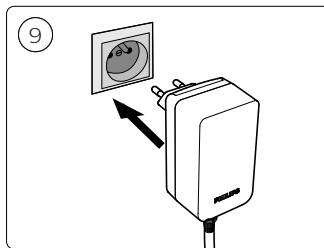
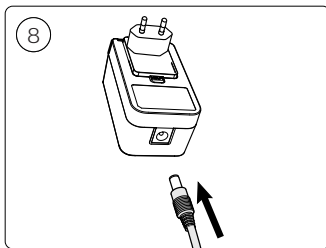
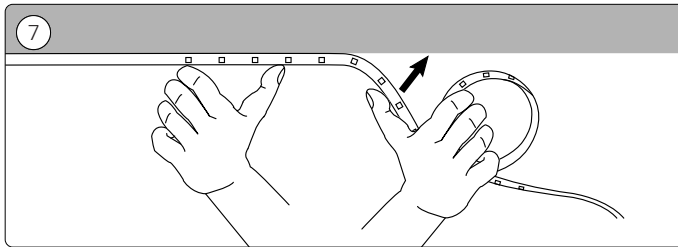

6

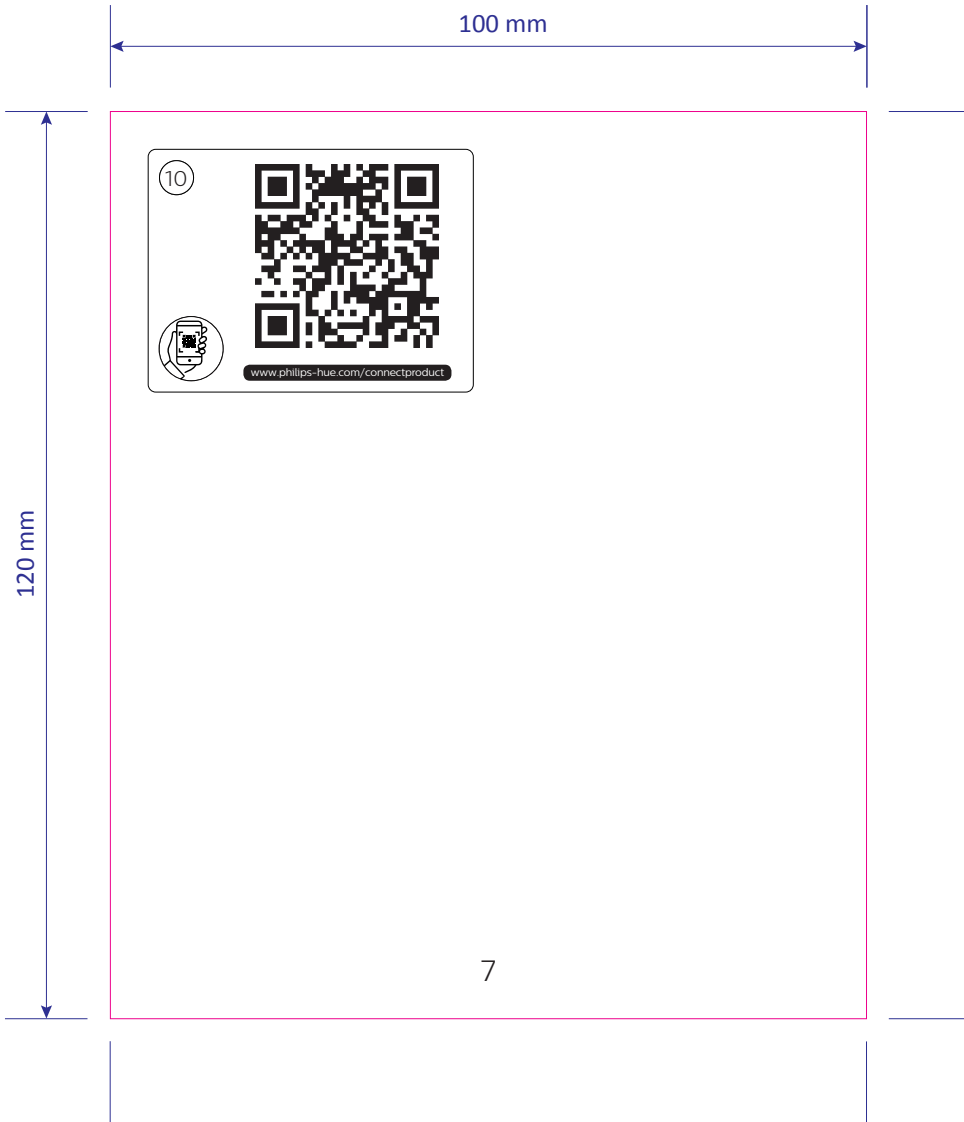

ARTWORK

Master Ref: **PHL468405**
TR Ref: **TR2164727**
Brand: PHILIPS
Brand execution: HUE White and Color Ambiance
Product name: Gradient Lightstrip extension
Shape: N/A
Wattage: N/A
Region: Trident UK
Artwork 12NC: 3222 639 08581
Die cut 12NC: DFX size
Barcode: N/A
CRC Number:
Action: **C**
Date: 13/07/2021

Project Manager: Margarita Papoutsis

Trident Artist: Michelle Hays

Technical & Non Printing Items

 Dieline  Guides

Colours:

Process black	1
	100%

PHILIPS



TRIDENT

Trident UK, Connaught House, Connaught Road,
Kingswood Business Park, Hull, HU7 3AP, England.
T: +44 (0) 01482 828100

Please note that any low resolution paper Canon colour
copies associated with this job should be referred to for
content, layout and colour separation only.

UNDER NO CIRCUMSTANCES SHOULD THIS
ARTWORK BE ALTERED WITHOUT PRIOR
PERMISSION FROM TRIDENT.

ARTWORK

Master Ref: **PHL468405**
TR Ref: **TR2164727**
Brand: PHILIPS
Brand execution: HUE White and Color Ambiance
Product name: Gradient Lightstrip extension
Shape: N/A
Wattage: N/A
Region: Trident UK
Artwork 12NC: 3222 639 08581
Die cut 12NC: DFX size
Barcode: N/A
CRC Number:
Action: **C**
Date: 13/07/2021

Project Manager: Margarita Papoutsi

Trident Artist: Michelle Hays

Technical & Non Printing Items

■ Dieline ■ Guides

Colours:

Process black	1
	1%
	2%

PHILIPS



TRIDENT

Trident UK, Connaught House, Connaught Road,
Kingswood Business Park, Hull, HU7 3AP, England.
T: +44 (0) 01482 828100

Please note that any low resolution paper Canon colour
copies associated with this job should be referred to for
content, layout and colour separation only.

UNDER NO CIRCUMSTANCES SHOULD THIS
ARTWORK BE ALTERED WITHOUT PRIOR
PERMISSION FROM TRIDENT.

100 mm

120 mm



Signify
I.B.R.S. / C.C.R.I. Numéro 10461
5600 VB Eindhoven,
the Netherlands
☎00800-74454775

© 2021 Signify Holding
All rights reserved

www.philips-hue.com

3222 639 08581
Last update: 07/2021