

AUFBAUANLEITUNG **DE**

INSTRUCTIONS DE MONTAGE **FR**

ISTRUZIONI DI MONTAGGIO **IT**

BOUWINSTRUCTIES **NL**

SZERELÉSI ÚTMUTATÓ **HU**

INSTRUCȚIUNI DE ASAMBLARE **RO**

NAVODILA ZA SESTAVLJANJE **SL**

NÁVOD PRO MONTÁŽ **CZ**

NÁVOD NA MONTÁŽ **SK**

MONTERINGSANVISNING **SE**

INSTRUKCJA MONTAŻU **PL**

УПУТСТВО ЗА МОНТАЖУ **RS**





PREMIUM SYSTEM-HAUS Q7,5 FIRSTLINE AUFBAUANLEITUNG

DE

Maße: L x B x H 274 x 274 x 218 cm



BESTIMMUNGSGEMÄSSE VERWENDUNG

Das Gerätehaus ist für den Einsatz im Freien vorgesehen und dient zum Aufbewahren von Gartenwerkzeugen, Geräten und Utensilien. Es ist nicht geeignet um Personen oder Tiere zu beherbergen oder Gefahrstoffe einzulagern. Das Gerätehaus ist nicht für den gewerblichen Gebrauch geeignet. Jegliche anderweitige Verwendung oder Veränderungen an dem Gerätehaus wird als unsachgemäße Verwendung betrachtet und kann erhebliche Gefahren verursachen.

HINWEIS

Lesen Sie die Aufbauanleitung sorgfältig, bevor Sie mit dem Aufbau des Gerätehauses beginnen.

Dies gilt insbesondere für die Sicherheitshinweise.

Andernfalls können Sie sich verletzen oder das Gerätehaus beschädigen.

Das Gerätehaus ist kein Klettergerüst für Kinder und keine Rankhilfe. Es besteht die Gefahr der Überlastung. Stellen Sie sicher, dass alle benötigten Bauteile in der angegebenen Menge vorhanden sind.

Führen Sie die einzelnen Aufbausritte nacheinander und in der angegebenen Reihenfolge, wie in dieser Anleitung vorgegeben, durch.

Überspringen Sie bitte keinen der angegebenen Schritte oder kürzen diese ab.

Verwahren Sie die Aufbauanleitung an einem sicheren Ort, um zu einem späteren Zeitpunkt erneut darauf zugreifen zu können.

Planen Sie den Aufbau! Bei Verwendung eines Bodenrahmens muss dieser zuerst montiert werden.

ALLGEMEINE INFORMATIONEN

Bevor Sie mit der Montage beginnen, stellen Sie sicher, dass die für Sie zutreffenden Richtlinien/Gesetze eingehalten werden. Planen Sie für die Montage mindestens 300 bis 360 Minuten Zeit ein. Für die Montage werden mindestens 4 Personen benötigt. Prüfen Sie vor dem Beginn der Arbeit, dass alle Teile in der richtigen Menge vorhanden sind. Nutzen Sie zum Aufbau eine freie, sonnige Fläche ohne überstehende Äste. Prüfen Sie die einzelnen Bauteile vor Montagebeginn auf ihre Unversehrtheit und legen Sie diese so, dass die Bauteile während der Arbeit gut erreichbar sind. Am besten bewahren Sie Kleinteile wie Schrauben, Mutter etc. in einer Schale auf, so dass diese nicht verloren gehen. Nutzen Sie das Gerätehaus auf keinen Fall als Rankhilfe für Hülsenfrüchte, Kletter- und Schlingpflanzen, Obst, Gemüse oder als Halterung für ihre Wäscheleine. Halten Sie das Gerätehaus frei von Schnee und Laub. **Die max. Traglast 150 kg/m².** Verwenden Sie das Gerätehaus ausschließlich wie in dieser Montageanleitung beschrieben. Der Hersteller oder Händler übernimmt keine Haftung für Schäden, die durch nicht bestimmungsgemäßen oder falschen Gebrauch entstanden sind. Stellen Sie das Gerätehaus nicht direkt auf Rasen oder unebene Untergründe, sorgen Sie für einen geeigneten, tragfähigen, waagerechten und stabilen Untergrund. Wir empfehlen das Gerätehaus fest auf dem Boden zu verankern. Stellen Sie sicher, dass alle Schrauben fest angezogen sind und dass der Rahmen richtig ausgerichtet und waagrecht ist. Prüfen Sie regelmäßig, dass alle Schrauben fest angezogen sind und ziehen Sie diese gegebenenfalls nach. **Einige Metallteile sind mit einer Schutzfolie versehen. Diese Folie muss vor Montagebeginn vorsichtig entfernt werden.**

SICHERHEITSHINWEISE

Stellen Sie sich niemals direkt auf die Dachfläche, es besteht die Gefahr der Überlastung. Auch nicht während der Montage oder zur Reinigung. Es besteht Gefahr für Kinder und Personen mit eingeschränkten physischen, sensorischen oder geistigen Fähigkeiten (z.B. übermüdete Personen, teilbehinderte Personen, ältere Personen mit reduzierten physischen und geistigen Fähigkeiten) oder Mangel an Erfahrung und Wissen (z.B. ältere Kinder). Bei der Montage des Gerätehauses kommen Kleinteile wie Schrauben und Muttern zum Einsatz, von denen Erstickungsgefahr ausgeht, wenn sie verschluckt werden. Das Gerätehaus darf nur von fachkundigen Personen aufgebaut werden, nicht von Kindern oder Personen mit eingeschränkten geistigen oder motorischen Fähigkeiten oder mangelnder Erfahrung. Der nicht sachgemäße Umgang mit dem Gerätehaus kann zu Verletzungen oder Sachschäden führen. Lassen Sie beim Auspacken der einzelnen Bauteile aus der Verpackung Vorsicht walten. **Es besteht Verletzungsgefahr an scharfen Kanten.** Einzelne Bauteile bestehen aus Metall und sind dadurch schwer. Bei einer unvorsichtigen Öffnung der Verpackung, zum Beispiel mit einem scharfen Messer oder einem anderen scharfen/spitzen Gegenstand besteht die Gefahr, dass Sie Bauteile beschädigen. Nach dem Auspacken der Bauteile prüfen Sie, ob alle Einzelteile in der richtigen Menge vorhanden sind. Legen Sie die einzelnen Teile auf eine Decke oder ähnliches, um Kratzer in der Beschichtung zu vermeiden. Kontrollieren Sie, ob die einzelnen Bauteile in einem einwandfreien Zustand sind oder Beschädigungen aufweisen, in diesem Fall verwenden Sie die beschädigten, deformierten Teile nicht. Tragen Sie während des Aufbaus und der Montage stets Sicherheitskleidung. Zur Grundausstattung gehören Sicherheitsschuhe, Schutzhandschuhe, Schutzbrille und Helm. Installieren Sie das Gerätehaus nicht an sehr windigen oder regnerischen Tagen. Stellen Sie sicher, dass die Bauteile keine Stromkabel berühren. Entsorgen Sie die Verpackung, Kunststoffbeutel oder Schutzfolien sachgemäß und halten Sie diese außerhalb der Reichweite von Kindern, Erstickungsgefahr! Stellen Sie das Gerätehaus auf eine ebene Fläche. Stellen Sie sicher, dass während der Montage keine Kinder im Gefahrenbereich anwesend sind. Platzieren Sie das Gerätehaus nicht in Bereichen, die starken oder andauernden Winden ausgesetzt sind. Zu Ihrer persönlichen Sicherheit sollten Sie das Gerätehaus nicht aufbauen, wenn Sie müde, alkoholisiert oder berauscht sind, bzw. wenn Sie sich schwindlig fühlen oder Ihnen unwohl ist. Wenn Sie Leitern oder elektronische Geräte verwenden, stellen Sie sicher, dass Sie sich an die jeweiligen Herstellerangaben zur Verwendung halten. Heiße Geräte wie Grills, Heizgeräte, Brenner etc. dürfen nicht in dem Gerätehaus verwendet oder gelagert werden, Brandgefahr! Stellen Sie sich bei Unwetter oder Gewitter nie in oder neben das Gerätehaus. Es besteht die Gefahr eines Blitzeinschlages.

PFLEGE UND INSTANDHALTUNG

Reinigen Sie die Oberfläche regelmäßig. Sollten Sie Kratzer in der Oberfläche bemerken, beseitigen Sie diese umgehend mit einem geeigneten Lack. Verwenden Sie keine aggressiven Reinigungsmittel, Bürsten mit Metall- oder Nylonbürsten sowie keine scharfen oder metallischen Hilfsmittel wie Messer oder Spachtel. Verwenden Sie zur Reinigung weiche Borsten. Verwenden Sie kaltes, sauberes Wasser.

WERKZEUGE UND AUSRÜSTUNG

Sicherheitskleidung (Sicherheitsschuhe, Schutzhandschuhe, Schutzbrille, Helm etc.)

Wasserwaage

Längenmesser

Standleiter (ca. 1,5 m Höhe)

Schrauben- oder Ratschen-Schlüssel

Akkuschrauber und Bohrmaschine mit ver. Aufsätzen

Schraubendreher

Dichtungsmaterial

(nicht im Lieferumfang enthalten)

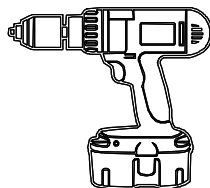
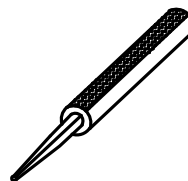
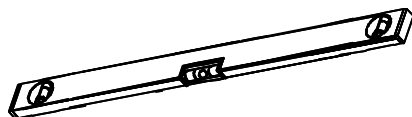
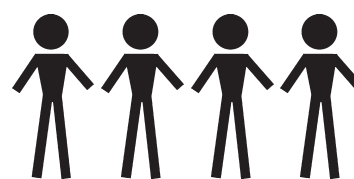

VERPACKUNGSENTSORGUNG

Entsorgen Sie die Verpackung sortenrein.

Pappe und Karton wird als Altpapier entsorgt und Folien führen Sie der entsprechenden Wertstoffsammlung zu.

ENTSORGUNG DES GERÄTEHAUSES

Achten Sie bei der Entsorgung des Gerätehauses auf die in Ihrem Land oder Bundesland geltenden Richtlinien, Gesetze und Bestimmungen bezüglich der Entsorgung.

ABMESSUNGEN

DE

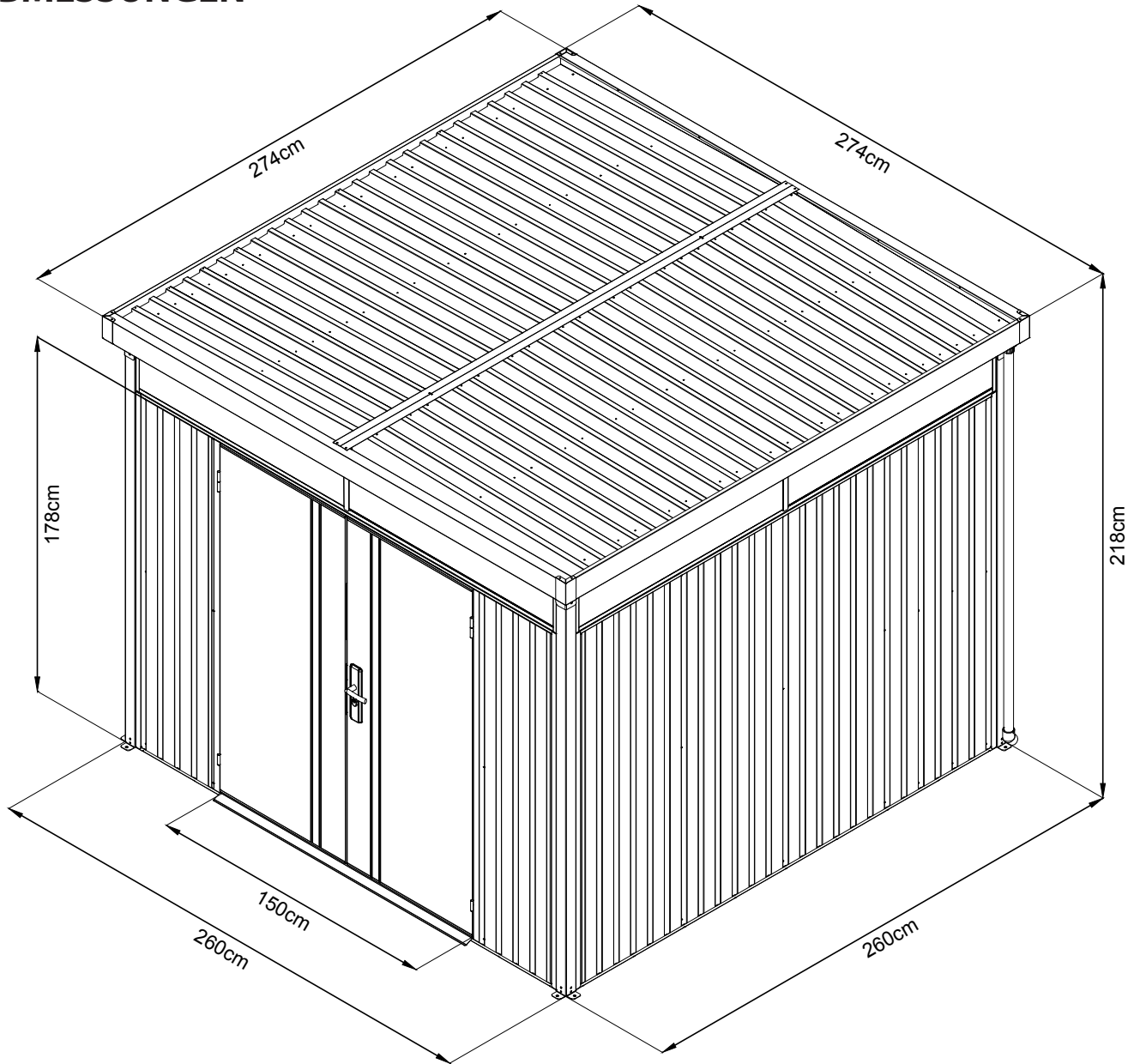

SYMBOLERKLÄRUNG



Montage mit/ohne Bodenrahmen ?



Montage mit Bodenrahmen



Montage ohne Bodenrahmen

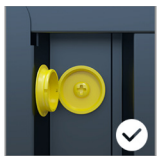

Unterlegscheiben-Kappe geöffnet lassen











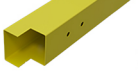

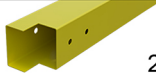
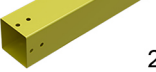
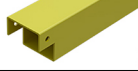



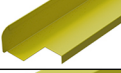

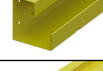







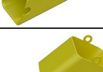



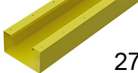

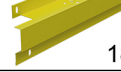
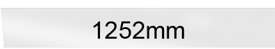
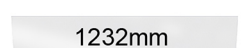



Unterlegscheiben-Kappe schließen

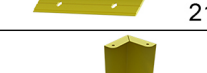

Rostschutz an Schnittkante aufbringen

TEILE-LISTE















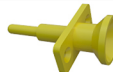

NR.	TEIL	MENGE
K2		4
K9	 2604mm	2
K4		4
K8	 2444mm	2
K7	 2059mm	4
13	 2542mm	2
K16		4
K17		4
KQ	 2520mm	4
C3	 2495mm	4
1	 2481mm	4
1-1	 2481mm	4
22	 2649mm	2
21	 1000mm	2
5	 1490mm	1
6	 1490mm	1
20	 2736mm	2
17L	 2737mm	1
17R	 2737mm	1
14-1	 2672mm	1
G9	 1990mm	2
G5	 60mm	2

NR.	TEIL	MENGE
14	 2720mm	1
7	 1819mm	8
4	 1819mm	2
P7	 1252mm	4
P8	 1232mm	4
P1	 1819mm	12
P2	 1819mm	2
P5	 1350mm	2
P6	 1350mm	2
P10	 1350mm	4
P9	 1350mm	16
C1	 2478mm	8
C9	 194mm	4
C10	 210mm	8
GC	 120mm	4
G11		2
M1		2
M3		2
C21		4

DE









TEILE-LISTE

NR.	TEIL	MENGE
D1	 1770mm	1
D2	 1770mm	1
SX		1
YS		1
SX1	 75mm	1

NR.	TEIL	MENGE
F1	 ST4.2*10	500
F2	 M4*10	60
F3	 M5*12	26
F5		34
F6		22
S2		120
S3		120
S4		190
F4		10
C20		4
G1		4
B6		4
QD8		4
M8		4
G3		2
FS		2
FS1		4

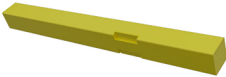
DE

TEILE-LISTE

NR.	TEIL	MENGE
BW		1
BN		1
BD		2
HZ1		1
HZ2		1
FG		1
FG1		2
FG2		2
FG3		2

MONTAGE-ÜBERSICHT

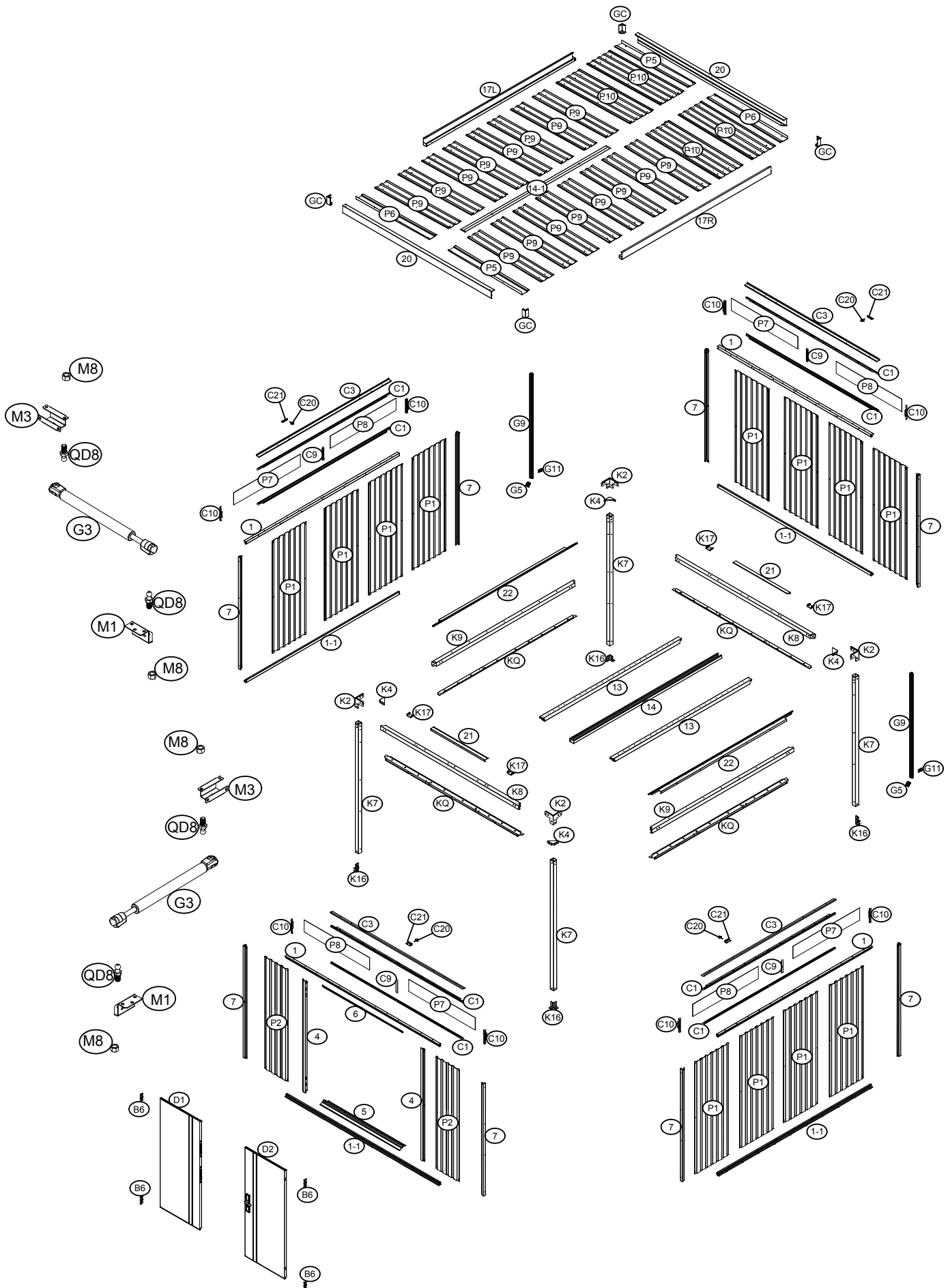

PRAKTISCHES ZUBEHÖR – OPTIONAL ERHÄLTlich

Bodenrahmen
Art.Nr. 018011

**2. Montage und
Platzierung des
Gerätehauses auf
dem Bodenrahmen.**



DE

**1. Montage und
Platzierung des
Bodenrahmens.**

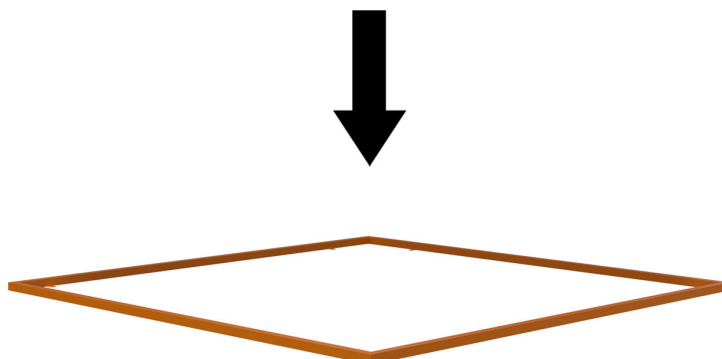

Bodenplatten aus Aluminium
Art.Nr. 018012

Als Unterbau empfehlen wir 4 cm starke XPS-Platten.
(nicht im Lieferumfang inbegriffen)

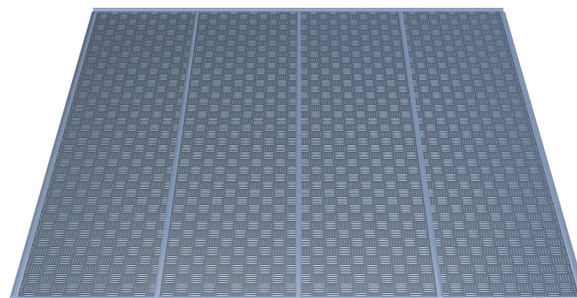

PREMIUM ABRI SYSTÈME AVEC VERRIÈRE Q7,5 FIRSTLINE INSTRUCTIONS DE MONTAGE

FR

Dimensions L x l x h 274 x 274 x 218 cm



UTILISATION CONFORME À L'USAGE PRÉVU

L'abri de jardin est prévu pour une utilisation en extérieur et sert à ranger des outils de jardin, des appareils et des ustensiles. Il ne convient pas pour héberger des personnes ou des animaux, ni pour stocker des substances dangereuses. L'abri de jardin ne convient pas à un usage professionnel. Toute autre utilisation ou modification de l'abri de jardin est considérée comme une utilisation non conforme et peut entraîner des risques importants.

NOTE

Lisez attentivement les instructions de montage avant de commencer à assembler l'abri de jardin.

Cela vaut en particulier pour les consignes de sécurité.

Sinon, vous pourriez être blessé ou endommager l'abri.

L'abri de jardin n'est pas un support d'escalade pour les enfants ni un tuteur pour les plantes grimpantes.

Il existe un risque de surcharge.

Assurez-vous que tous les éléments nécessaires à la construction sont disponibles dans les quantités spécifiées.

Effectuez les différentes étapes de montage l'une après l'autre et dans l'ordre indiqué, comme décrit dans la présente notice.

Veuillez ne pas sauter ou abréger l'une des étapes indiquées.

Conservez la notice de montage dans un endroit sûr afin de pouvoir vous y référer ultérieurement.

Planifiez la construction! Lors de l'utilisation d'un cadre de sol, celui-ci doit être monté en premier.

INFORMATIONS GÉNÉRALES

Avant de commencer le montage, assurez-vous que les directives/lois qui vous sont applicables sont respectées.

Prévoyez au moins 300 à 360 minutes pour le montage.

Au moins 4 personnes sont nécessaires pour le montage.

Avant de commencer le travail, vérifiez que toutes les pièces sont disponibles dans les quantités requises.

Utilisez un espace libre et ensoleillé dépourvu de branches saillantes pour le montage.

Vérifiez l'intégrité des différents composants avant de commencer l'assemblage et placez-les de manière à ce qu'ils soient facilement accessibles pendant le travail.

Il est préférable de conserver les petites pièces telles que les vis, les écrous, etc. dans un bol afin de ne pas les perdre.

N'utilisez en aucun cas l'abri de jardin comme tuteur pour les légumineuses, les plantes grimpantes et rampantes, les fruits, les légumes ou comme support pour votre corde à linge.

Veillez à ce que l'abri soit exempt de neige et de feuilles. **La charge maximale supportée est de 150 kg/m².**

Utilisez l'abri uniquement de la manière décrite dans ces instructions de montage.

Le fabricant ou le revendeur déclinent toute responsabilité pour les dommages causés par une utilisation incorrecte ou inappropriée. Ne placez pas l'abri directement sur l'herbe ou sur un terrain inégal, assurez-vous que le sol soit approprié, porteur, horizontal et stable. Nous recommandons de fixer solidement l'abri au sol. Assurez-vous que toutes les vis sont bien serrées et que le cadre est bien aligné et horizontal. Vérifiez régulièrement que toutes les vis sont bien serrées et resserrez-les le cas échéant. **Certaines pièces métalliques sont recouvertes d'un film protecteur.**

Ce film doit être enlevé avec précaution avant le début du montage.

CONSIGNES DE SÉCURITÉ

Ne vous placez jamais directement sur le toit, il y a un risque de surcharge. Et ce que ce soit pour le montage ou pour le nettoyage.

Il existe un danger pour les enfants et les personnes aux capacités physiques, sensorielles ou mentales limitées (par exemple, les personnes surmenées, les personnes partiellement handicapées, les personnes âgées aux capacités physiques et mentales diminuées) ou qui manquent d'expérience et de connaissances (par exemple, les enfants plus âgés). Lors du montage de l'abri, on utilise de petites pièces telles que des écrous et des boulons qui présentent un risque de suffocation en cas d'ingestion.

L'abri de jardin ne doit être monté que par des personnes compétentes, et non par des enfants ou des personnes ayant des capacités mentales ou motrices limitées ou manquant d'expérience.

Une mauvaise manipulation de l'abri peut entraîner des blessures ou des dégâts matériels.

Soyez prudents lors du déballage des différentes pièces. **Il y a un risque de blessure sur les bords tranchants.**

Certains éléments sont en métal, donc lourds. Si vous ouvrez l'emballage sans précautions, par exemple avec un couteau pointu ou un autre objet pointu/affûté, vous risquez d'endommager des éléments. Après avoir déballé les pièces, vérifiez que toutes les pièces individuelles sont disponibles dans les quantités indiquées.

Disposez les différents éléments sur une couverture ou un objet similaire pour éviter de rayer le revêtement.

Vérifiez que les différentes pièces sont en parfait état ou si elles présentent des signes de détérioration, auquel cas n'utilisez pas les éléments endommagés et déformés.

Portez toujours des vêtements de sécurité lors du montage et de l'installation. L'équipement de base comprend des chaussures de sécurité, des gants de protection, des lunettes de sécurité et un casque.

N'installez pas l'abri les jours de grand vent ou de pluie.

Assurez-vous que les éléments ne touchent aucun câble d'alimentation électrique.

Éliminez l'emballage, les sachets en plastique ou les films de protection de manière conforme et tenez-les hors de portée des enfants. Risque de suffocation !

Placez l'abri de jardin sur une surface plane.

Assurez-vous qu'aucun enfant n'est présent dans la zone de danger pendant le montage.

Ne placez pas l'abri dans des zones exposées à des vents forts ou continus.

Pour votre propre sécurité, vous ne devez pas installer le hangar si vous êtes fatigué, ivre ou intoxiqué, ou si vous vous sentez étourdi ou malade.

Si vous utilisez des échelles ou des équipements électroniques, assurez-vous de suivre les instructions d'utilisation du fabricant respectif. Les appareils chauds tels que les grils, les chauffages, les brûleurs, etc. ne doivent pas être utilisés ou stockés dans l'abri de jardin, il y a un risque d'incendie ! Ne restez jamais dans l'abri ou à côté de celui-ci pendant un orage ou une tempête. Il existe un risque de foudroiement.

ENTRETIEN ET MAINTENANCE

Nettoyez régulièrement la surface. Si vous remarquez des rayures sur la surface, enlevez-les rapidement avec une peinture appropriée.

N'utilisez pas de produits de nettoyage agressifs, de brosses avec des pinceaux en métal ou en nylon ou d'outils pointus ou métalliques tels que des couteaux ou des spatules. Utilisez des brosses à poils souples pour le nettoyage. Utilisez de l'eau froide et propre.

OUTILS ET ÉQUIPEMENTS

Vêtements de sécurité (chaussures de sécurité, gants de protection, lunettes de sécurité, casque, etc.)

Niveau à bulle

Mètre

Escabeau ou échelle double (env. 1,5 m. de hauteur)

Clé simple ou clé à cliquet

Vis pour visseuse et perceuse avec divers. extensions

Tournevis

Matériel d'étanchéité

(non inclus dans la livraison)

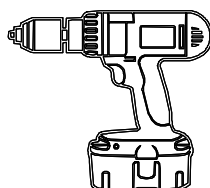
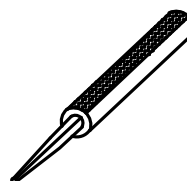
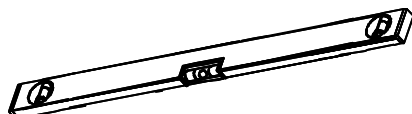

ÉLIMINATION DES EMBALLAGES

Éliminez les emballages en les triant.

Les cartons sont éliminés comme des déchets de papier et les films d'emballage doivent être affectés à la collecte appropriée des matériaux recyclables.

MISE AU REBUT DE L'ABRI DE JARDIN

Lors de l'élimination de l'abri de jardin, respectez les directives, les lois et les règlements applicables dans votre pays ou état fédéral en matière d'élimination des déchets.

DIMENSIONS

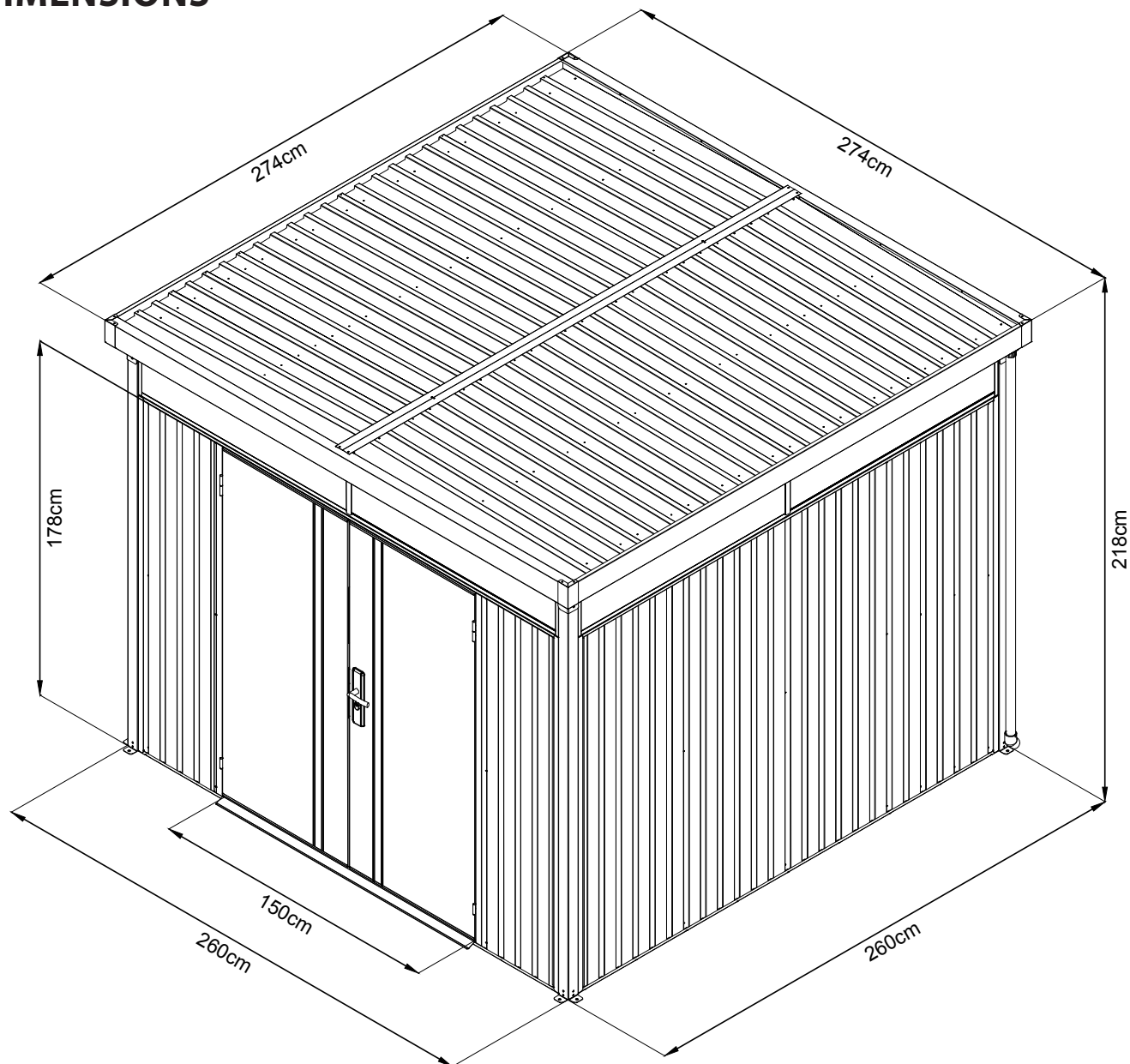

FR

EXPLICATION DES SYMBOLES



Montage avec / sans
cadre au sol ?



Montage avec cadre au sol



Assemblage sans cadre au sol



Laisser ouvert / ouvrir
le capuchon à rondelle plate



























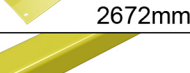





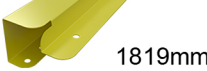

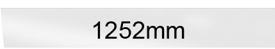
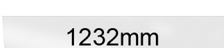

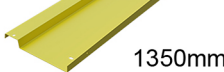

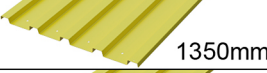
Fermer le capuchon
à rondelle plate

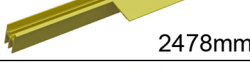

appliquer une protection contre
la rouille sur le bord de coupe

















LISTE DES PIÈCES

N° DE PIÈCE	PIÈCE	QUANTITÉ
K2		4
K9	 2604mm	2
K4		4
K8	 2444mm	2
K7	 2059mm	4
13	 2542mm	2
K16		4
K17		4
KQ	 2520mm	4
C3	 2495mm	4
1	 2481mm	4
1-1	 2481mm	4
22	 2649mm	2
21	 1000mm	2
5	 1490mm	1
6	 1490mm	1
20	 2736mm	2
17L	 2737mm	1
17R	 2737mm	1
14-1	 2672mm	1
G9	 1990mm	2
G5	 60mm	2







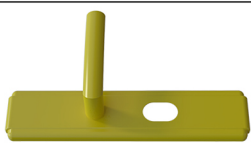

N° DE PIÈCE	PIÈCE	QUANTITÉ
14	 2720mm	1
7	 1819mm	8
4	 1819mm	2
P7	 1252mm	4
P8	 1232mm	4
P1	 1819mm	12
P2	 1819mm	2
P5	 1350mm	2
P6	 1350mm	2
P10	 1350mm	4
P9	 1350mm	16
C1	 2478mm	8
C9	 194mm	4
C10	 210mm	8
GC	 120mm	4
G11		2
M1		2
M3		2
C21		4

LISTE DES PIÈCES

N° DE PIÈCE	PIÈCE	QUANTITÉ
D1	 1770mm	1
D2	 1770mm	1
SX		1
YS		1
SX1	 75mm	1

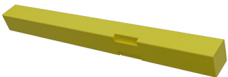
N° DE PIÈCE	PIÈCE	QUANTITÉ
F1	 ST4.2*10	500
F2	 M4*10	60
F3	 M5*12	26
F5		34
F6		22
S2		120
S3		120
S4		190
F4		10
C20		4
G1		4
B6		4
QD8		4
M8		4
G3		2
FS		2
FS1		4

LISTE DES PIÈCES

N° DE PIÈCE	PIÈCE	QUANTITÉ
BW		1
BN		1
BD		2
HZ1		1
HZ2		1
FG		1
FG1		2
FG2		2
FG3		2

VUE D'ENSEMBLE DU MONTAGE

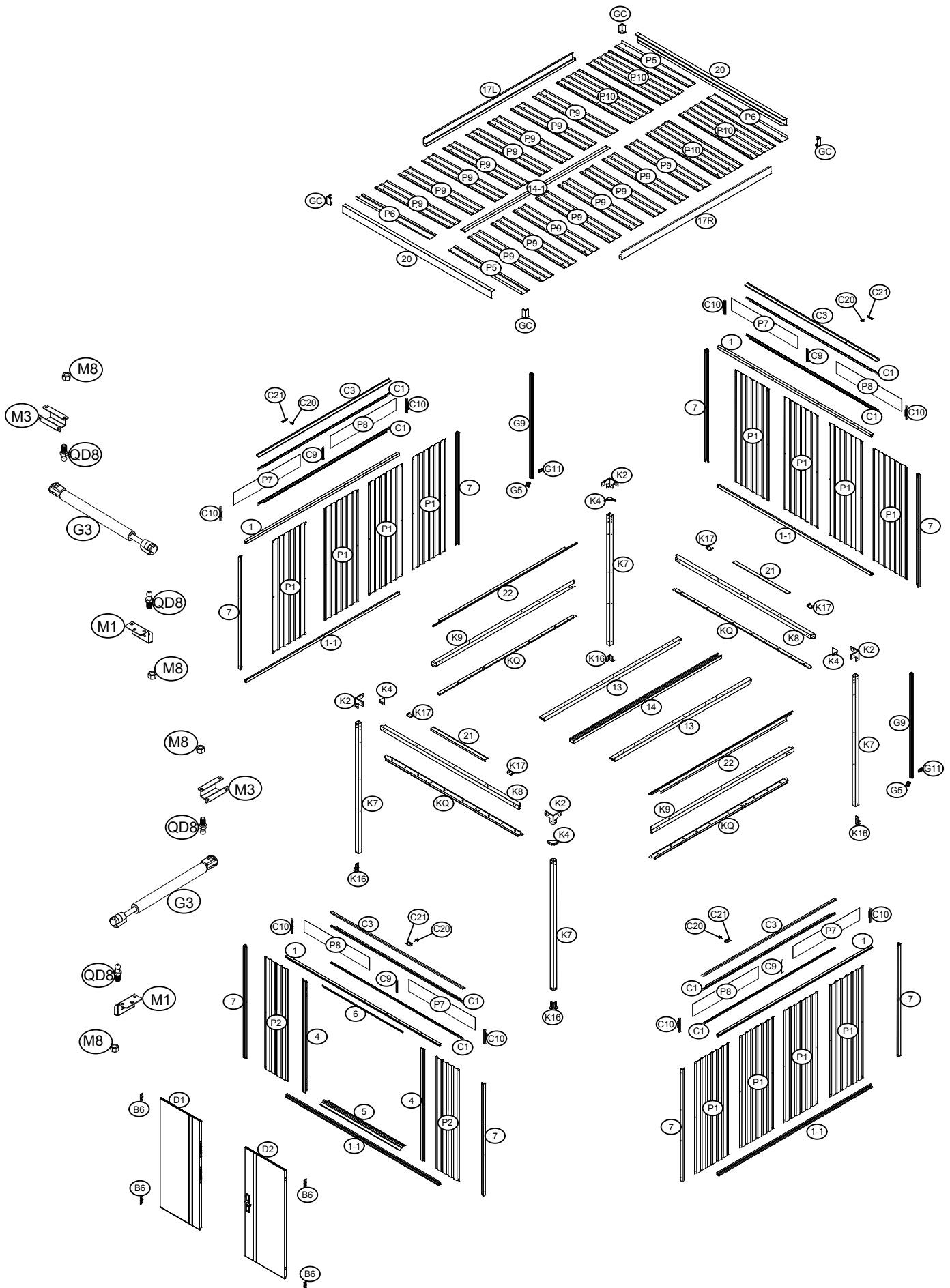

ACCESSOIRES PRATIQUES – DISPONIBLES EN OPTION

cadre de sol
N° d'article : 018011

2. Montage et
placement de la maison
sur le cadre de sol.



FR

1. Montage et
placement du cadre
de sol.

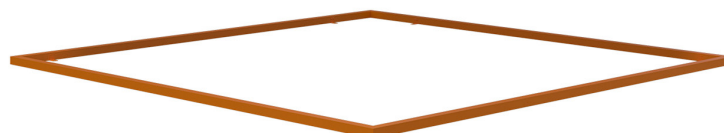
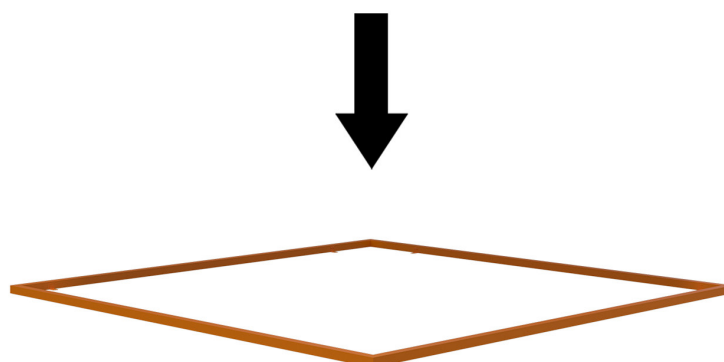

Panneaux de sol en aluminium
N° d'article : 018012

Nous recommandons comme support
des panneaux XPS de 4 cm d'épaisseur.
(non inclus dans la livraison)

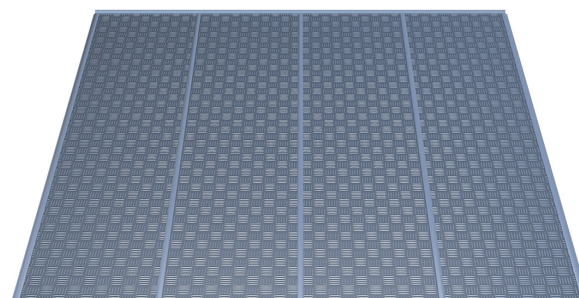

CASA PREFABBRICATA PREMIUM Q7,5 FIRSTLINE ISTRUZIONI PER IL MONTAGGIO

Dimensioni: L x P x H 274 x 274 x 218 cm

IT



UTILIZZO CONFORME ALLA DESTINAZIONE D'USO

La casa per gli attrezzi è prevista per uso all'aperto e serve per il deposito di attrezzi di giardinaggio, apparecchi e utensili. Non è adatta per ospitare persone o animali o per depositare sostanze pericolose. La casa per gli attrezzi non è adatta per uso commerciale. Qualsiasi utilizzo diverso o modifica della casa per gli attrezzi viene considerata uso improprio e può causare gravi rischi.

NOTA

Leggere attentamente le istruzioni di montaggio prima di cominciare a montare la casa per gli attrezzi.

Ciò vale in particolare per le istruzioni di sicurezza.

In caso contrario, si potrebbero verificare lesioni personali o danni alla casa per gli attrezzi.

La casa per gli attrezzi non è una struttura per arrampicata per bambini né un graticcio per piante.

Esiste il rischio di sovraccarico.

Accertarsi che tutti i componenti necessari siano disponibili nella quantità indicata.

Eseguire le singole fasi di montaggio nella sequenza indicata, come specificato nelle presenti istruzioni.

Non saltare o abbreviare alcun passaggio indicato.

Conservare le istruzioni di montaggio in un luogo sicuro, in modo da poterle consultare in un secondo momento.

Programmare il montaggio! Qualora si utilizzi un telaio di fondazione questo va montato per primo.

INFORMAZIONI GENERALI

Prima di iniziare il montaggio accertarsi che le relative direttive / disposizioni di legge siano rispettate.

Per il montaggio prevedere almeno da 300 a 360 minuti.

Per il montaggio sono necessarie almeno 4 persone. Prima di iniziare il lavoro, verificare che tutti i pezzi siano disponibili nella quantità corretta. Per il montaggio scegliere una superficie libera, assoluta senza rami soprastanti.

Prima di iniziare il montaggio, verificare che i singoli componenti siano integri e posizionarli in modo che siano ben accessibili durante le fasi di lavoro.

È preferibile conservare la minuteria come viti, dadi ecc. in una ciotola, in modo che non vadano persi.

Non utilizzare mai la casa per gli attrezzi come supporto per le leguminose, per le piante rampicanti, per la frutta, per la verdura o per il filo per stendere il bucato.

Mantenere la casa degli attrezzi priva di neve e di fogliame. **La portata max. è 150 kg/m².**

Utilizzare la casa per gli attrezzi esclusivamente come descritto in queste istruzioni di montaggio.

Il produttore / rivenditore declina ogni responsabilità per i danni dovuti a un uso improprio o errato.

Non collocare la casa per gli attrezzi direttamente sull'erba o su fondo irregolare, predisporre una base adeguata, in grado di sostenere il peso, orizzontale e stabile. Si consiglia di ancorare saldamente sul terreno la casa per attrezzi.

Accertarsi che tutte le viti siano saldamente serrate e che il telaio sia eretto correttamente e fissato in bolla.

Verificare regolarmente che tutte le viti siano correttamente serrate e nel caso serrarle ulteriormente. **Alcuni particolari metallici sono protetti da apposita pellicola. Questa va attentamente rimossa prima di cominciare il montaggio.**

INDICAZIONI DI SICUREZZA

Non stare mai in piedi direttamente sul tetto, esiste il rischio di sovraccarico. Neppure durante il montaggio o per la pulizia.

Sussiste un rischio per i bambini e per le persone con capacità fisiche, sensoriali o intellettive ridotte (ad es. persone sovraffaticate, persone parzialmente disabili, persone anziane con capacità fisiche e intellettive ridotte) o con scarsa esperienza e competenza (ad es. bambini più grandi).

Durante il montaggio della casa per gli attrezzi vengono utilizzate parti di piccole dimensioni, come viti e dadi, che rappresentano un rischio di soffocamento se ingerite.

La casa per gli attrezzi deve essere montata solo da persone qualificate, non da bambini o da persone con capacità intellettive o motorie ridotte o senza esperienza.

L'uso improprio della casa per gli attrezzi può causare lesioni alle persone o danni alle cose.

Estrarre con cautela i singoli componenti dall'imballaggio. **Rischio di lesioni causate da spigoli vivi.**

Alcuni componenti sono di metallo e quindi pesanti. Se l'imballaggio viene aperto in modo incauto, ad esempio con un coltello affilato o un altro oggetto affilato/appuntito, sussiste il rischio di danneggiare i componenti.

Dopo aver disimballato i componenti, verificare che i singoli pezzi siano tutti disponibili nella quantità corretta.

Disporre i singoli componenti su una coperta o simile, per evitare di graffiare il rivestimento.

Verificare che i singoli componenti siano in perfette condizioni e che non siano danneggiati; in tal caso, non utilizzare le parti danneggiate e deformate.

Durante il montaggio e l'installazione indossare sempre indumenti di sicurezza. L'equipaggiamento di base comprende scarpe di sicurezza, guanti di protezione, occhiali di sicurezza e casco.

Non installare la casa per gli attrezzi in giornate molto ventose o piovose.

Assicurarsi che i componenti non entrino in contatto con cavi elettrici.

Smaltire correttamente l'imballaggio, i sacchetti di plastica o la pellicola protettiva e tenerli fuori dalla portata dei bambini per evitare il rischio di soffocamento!

Posizionare la casa per gli attrezzi su una superficie piana.

Assicurarsi che durante l'installazione non siano presenti bambini nella zona di pericolo.

Non collocare la casa per gli attrezzi in zone esposte a venti forti o costanti.

Per la sicurezza personale dell'utilizzatore non assemblare la casa per gli attrezzi in caso di stanchezza, assunzione di bevande alcoliche o di stupefacenti, o in presenza di capogiri o di malessere.

Se si utilizzano scale o apparecchi elettronici, assicurarsi di seguire le istruzioni per l'uso del produttore.

Non mettere in funzione né depositare apparecchi come grill, stufe, fornelli, ecc. nella casa per gli attrezzi, pericolo di incendio! In caso di maltempo o temporale non stare mai all'interno o accanto alla casa per gli attrezzi.

Pericolo di fulmini.

CURA E MANUTENZIONE

Pulire regolarmente la superficie. Qualora si notino graffi sulla superficie, eliminarli prontamente con una vernice apposita.

Non utilizzare detergenti aggressivi, spazzole con setole in metallo o nylon e utensili taglienti in metallo per la pulizia, come coltelli o spatole. Per la pulizia utilizzare setole morbide. Utilizzare acqua pulita, fredda.

UTENSILI E ATTREZZATURE

Abbigliamento di sicurezza (scarpe di sicurezza, guanti di protezione, occhiali di sicurezza, casco, ecc.)

Livella

Metro lineare

Scala (altezza ca. 1,5 m)

Chiave a vite o a cricchetto

Avvitatore a batteria e trapano con vari accessori

Cacciavite

Guarnizioni

(non in dotazione)

IT



SMALTIMENTO DELL'IMBALLAGGIO

Smaltire l'imballaggio in modo adeguato.

Il cartone e il cartoncino vengono smaltiti come carta da macero e le pellicole vengono smaltite nella raccolta differenziata apposita.

SMALTIMENTO DELLA CASA PER GLI ATTREZZI

Per lo smaltimento della casa per gli attrezzi rispettare le direttive, disposizioni di legge e specifiche di smaltimento vigenti nel proprio paese o regione.

DIMENSIONI

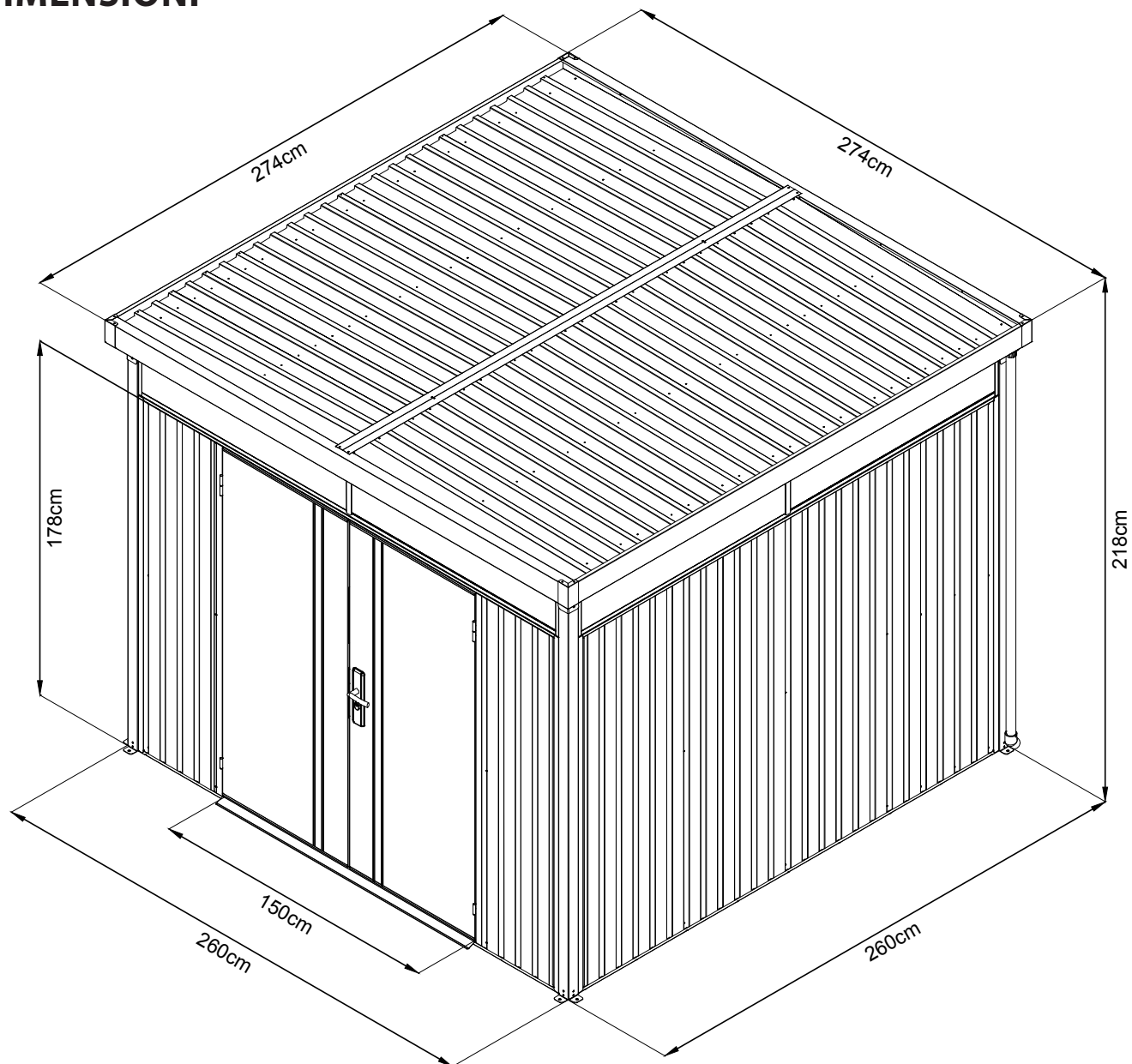

IT

SPIEGAZIONE DEI SIMBOLI



+ ?



Lasciare tappo delle
rondelle aperto / aprire



Chiudere tappo
delle rondelle



Montaggio con telaio
a pavimento





























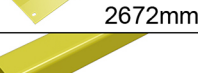





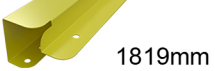

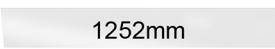
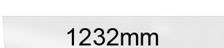



Montaggio senza telaio
a pavimento

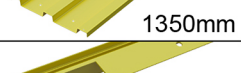
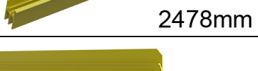

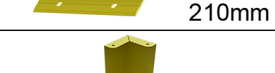
Applicare una protezione
antiruggine sul bordo di taglio



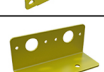







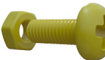



ELENCO DEI PEZZI

N°	COMPONENTE	QUANTITÀ
K2		4
K9	 2604mm	2
K4		4
K8	 2444mm	2
K7	 2059mm	4
13	 2542mm	2
K16		4
K17		4
KQ	 2520mm	4
C3	 2495mm	4
1	 2481mm	4
1-1	 2481mm	4
22	 2649mm	2
21	 1000mm	2
5	 1490mm	1
6	 1490mm	1
20	 2736mm	2
17L	 2737mm	1
17R	 2737mm	1
14-1	 2672mm	1
G9	 1990mm	2
G5	 60mm	2

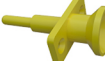
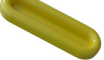

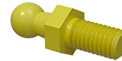



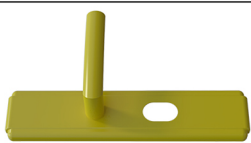

N°	COMPONENTE	QUANTITÀ
14	 2720mm	1
7	 1819mm	8
4	 1819mm	2
P7	 1252mm	4
P8	 1232mm	4
P1	 1819mm	12
P2	 1819mm	2
P5	 1350mm	2
P6	 1350mm	2
P10	 1350mm	4
P9	 1350mm	16
C1	 2478mm	8
C9	 194mm	4
C10	 210mm	8
GC	 120mm	4
G11		2
M1		2
M3		2
C21		4

ELENCO DEI PEZZI

N°	COMPONENTE	QUANTITÀ
D1	 1770mm	1
D2	 1770mm	1
SX		1
YS		1
SX1	 75mm	1

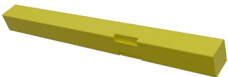
N°	COMPONENTE	QUANTITÀ
F1	 ST4.2*10	500
F2	 M4*10	60
F3	 M5*12	26
F5		34
F6		22
S2		120
S3		120
S4		190
F4		10
C20		4
G1		4
B6		4
QD8		4
M8		4
G3		2
FS		2
FS1		4

ELENCO DEI PEZZI

N°	COMPONENTE	QUANTITÀ
BW		1
BN		1
BD		2
HZ1		1
HZ2		1
FG		1
FG1		2
FG2		2
FG3		2

PANORAMICA DEL MONTAGGIO

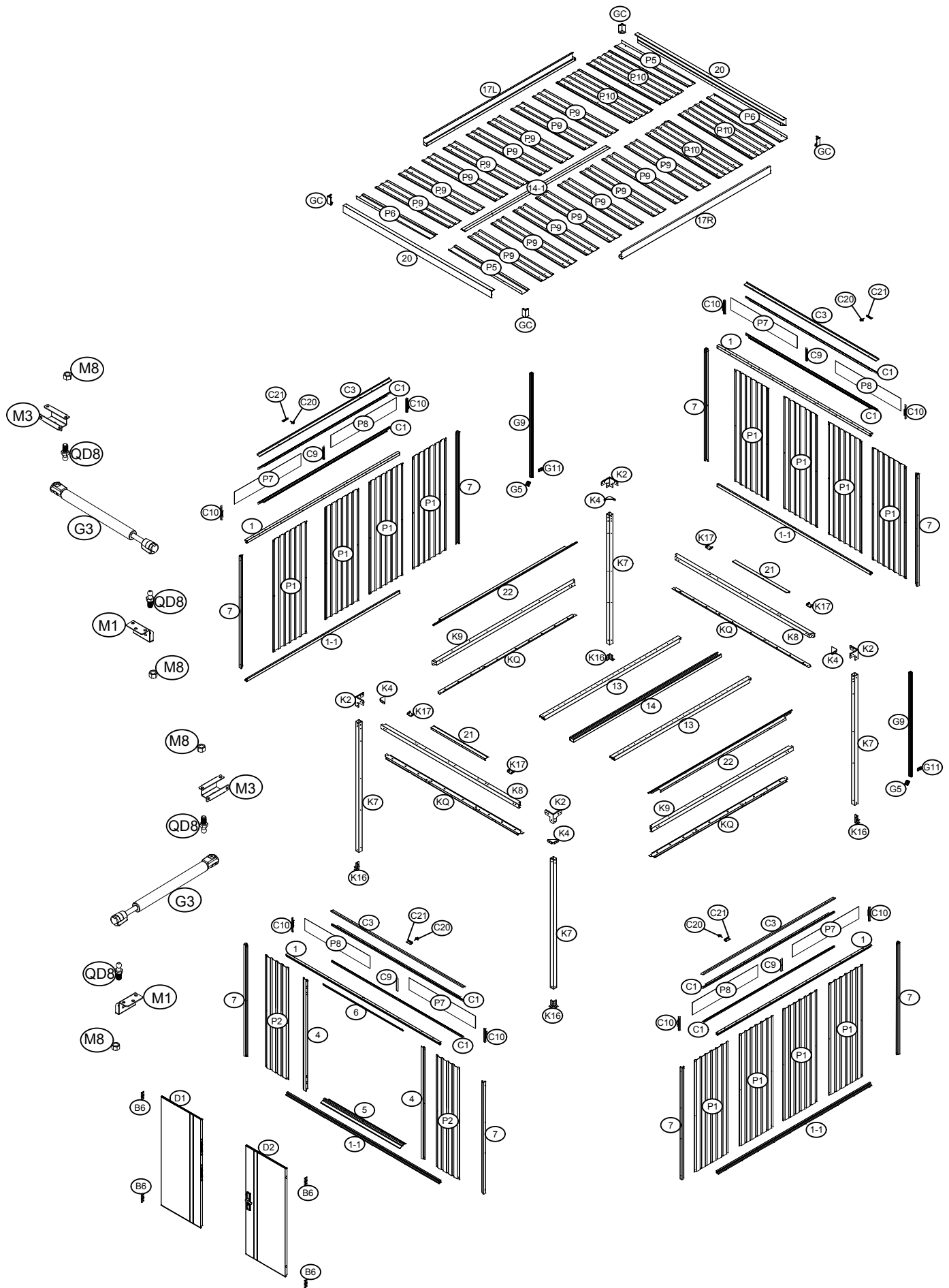

ACCESSORI PRATICI – DISPONIBILI IN OPZIONE

Telaio a pavimento
Art. N° 018011

**2. Montaggio e
posizionamento della
casa per gli attrezzi sul
telaio a pavimento.**



**1. Montaggio e
posizionamento del
telaio a pavimento.**

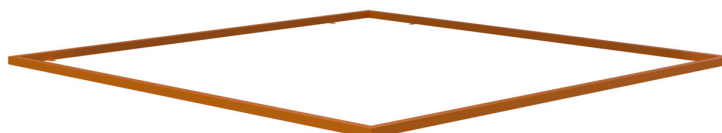

Piastre di fondazione in alluminio
Art. N° 018012

Come base si consigliano 4 lastre XPS spessore 4 cm.
(non in dotazione)

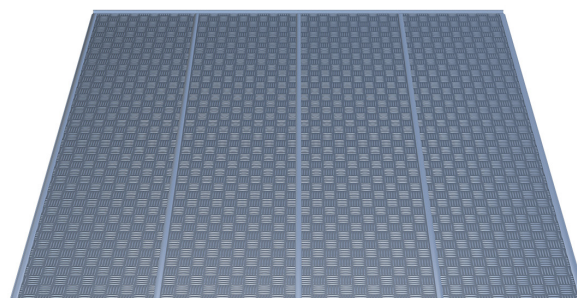

PREMIUM GEREEDSCHAPSSCHUUR MET DAKRAAM 7,5 FIRSTLINE BOUWINSTRUCTIES

Afmetingen: L x B x H 274 x 274 x 218 cm

NL



BEOOGD GEBRUIK

De gereedschapsschuur is bedoeld voor gebruik in de open lucht en heeft als doel om tuingereedschap, werktuig en toebehoren op te slaan. Hij is niet geschikt voor het onderbrengen van personen of dieren of de opslag van gevaarlijke stoffen. De gereedschapsschuur is niet bedoeld voor zakelijk gebruik. Elk afwijkend gebruik of elke verandering aan de gereedschapsschuur wordt beschouwd als niet-beoogd gebruik en kan aanzienlijke risico's met zich meebrengen.

OPMERKING

Lees de bouwinstructies zorgvuldig door voordat u de gereedschapsschuur gaat bouwen.

Dit geldt in het bijzonder voor de veiligheidsinstructies.

Doet u dit niet, dan kunt u letsel oplopen of de gereedschapsschuur beschadigen.

De gereedschapsschuur is geen klimtoestel voor kinderen en geen klimhulp. Er is een risico op overbelasting.

Zorg dat alle benodigde onderdelen aanwezig zijn in de aangegeven aantallen.

Voer de stappen na elkaar uit, in de volgorde die in deze handleiding staat.

Sla geen stappen of onderdelen van stappen over.

Bewaar de bouwinstructies op een veilige plek zodat u ze er later weer bij kunt pakken.

Plan de bouw! Bij gebruik van een vloerframe dient deze eerst gemonteerd te worden.

ALGEMENE INFORMATIE

Zorg voordat u met de montage begint dat er wordt voldaan aan alle geldende richtlijnen en wetten.

Maak voor de montage minimaal 300 tot 360 minuten tijd vrij.

Voor de montage zijn minimaal 4 personen nodig. Controleer voordat u begint of alle onderdelen in de juiste aantallen aanwezig zijn. Gebruik voor het bouwen een vrije, zonnige plek zonder overhangende takken.

Controleer voor de montage of alle onderdelen volledig intact zijn en leg ze zo neer dat ze tijdens het werk goed bereikbaar zijn.

U kunt kleine onderdelen zoals schroeven en moeren het beste in een bakje leggen zodat u ze niet kwijtraakt.

Gebruik de gereedschapsschuur nooit als klimhulp voor peulvruchten, klim- en slingerplanten, groente of fruit of als steunpunt voor uw waslijn.

Hou de gereedschapsschuur vrij van sneeuw en bladeren. **De maximale draaglast is 150 kg/m².**

Gebruik de gereedschapsschuur alleen zoals in deze montagehandleiding omschreven staat.

De fabrikant of verkoper is niet aansprakelijk voor schade die voortvloeit uit abnormaal of onjuist gebruik.

Zet de gereedschapsschuur niet rechtstreeks op gras of ongelijke ondergronden.

Zorg voor een geschikte, sterke, vlakke en stabiele ondergrond.

We raden aan om de gereedschapsschuur stevig te verankeren in de bodem. Zorg dat alle schroeven stevig zijn aangehaald en dat het frame correct en waterpas staat. Controleer regelmatig of alle schroeven stevig vastzitten en draai ze waar nodig weer vast.

Een aantal metalen onderdelen is voorzien van beschermfolie. Deze folie moet voor het begin van de montage zorgvuldig worden verwijderd.

VEILIGHEIDSINSTRUCTIES

Ga nooit rechtstreeks op het dak staan, er bestaat risico op overbelasting. Doe dit ook niet tijdens de montage of om schoon te maken.

Er is een risico voor kinderen en personen met beperkte lichamelijke, zintuiglijke of geestelijke vaardigheden (bijvoorbeeld oververmoeide personen, mensen met een gedeeltelijke beperking of oudere personen met verminderde lichamelijke en geestelijke vaardigheden) of met beperkte ervaring en kennis (bijvoorbeeld oudere kinderen).

Bij de montage van de gereedschapsschuur worden kleine onderdelen gebruikt, zoals schroeven en moeren.

Deze brengen bij inslikken een verstikkingsgevaar met zich mee.

De gereedschapsschuur mag alleen worden gebouwd door deskundige personen, en niet door kinderen of door personen met beperkte geestelijke of motorische vaardigheden of met een gebrek aan ervaring.

Onjuist gebruik van de gereedschapsschuur kan letsel of schade veroorzaken.

Wees voorzichtig bij het uitpakken van de afzonderlijke onderdelen uit de verpakking. **Er is een risico op letsel door scherpe randen.** Sommige onderdelen zijn van metaal en zijn daardoor zwaar. Als u de verpakking niet voorzichtig opent, bijvoorbeeld door een scherp mes of een ander scherp of spits voorwerp te gebruiken, is er een risico dat u onderdelen beschadigt. Controleer na het uitpakken of alle onderdelen aanwezig zijn in de juiste aantallen.

Leg de losse onderdelen op een deken of een soortgelijke ondergrond om krassen in de coating te voorkomen.

Controleer of alle onderdelen volledig intact zijn en niet beschadigd zijn. In dat laatste geval dient u de beschadigde, vervormde onderdelen niet te gebruiken.

Draag altijd veiligheidskleding tijdens de bouw en de montage. De basisuitrusting bestaat uit veiligheidsschoenen, veiligheidshandschoenen, een veiligheidsbril en een helm.

Installeer de gereedschapsschuur niet op dagen met veel regen of wind.

Zorg dat de onderdelen niet in contact komen met stroomkabels.

Verpakking, kunststof zakje of beschermfolie correct verwijderen en deze buiten het bereik van kinderen houden, verstikkingsgevaar!

Zet de gereedschapsschuur op een vlakke ondergrond.

Zorg dat er tijdens de montage geen kinderen aanwezig zijn in de gevarezone.

Zet de gereedschapsschuur niet op plekken die worden blootgesteld aan harde of continue wind.

Voor uw eigen veiligheid wordt afgeraden om de gereedschapsschuur te bouwen als u moe, beschonken of onder invloed bent of als u zich duizelig of niet goed voelt.

Als u ladders of elektronische apparaten gebruikt, zorg dan dat u zich houdt aan de gebruiksinstructies van de betreffende fabrikant. Gebruik en bewaar geen hete apparatuur in de gereedschapsschuur, zoals barbecues, verwarmingstoestellen en branders. Hierbij bestaat brandgevaar! Ga bij onweer niet in of naast de gereedschapsschuur staan. Er is een risico op blikseminslag.

VERZORGING EN ONDERHOUD

Maak de oppervlakken regelmatig schoon. Ziet u krassen in het oppervlak, repareer deze dan onmiddellijk met geschikte lak.

Gebruik geen agressieve schoonmaakmiddelen, borstels met metalen of nylon haren, of scherpe of metalen hulpmiddelen zoals messen of spatels. Gebruik bij het schoonmaken zachte borstels.

Gebruik koud en schoon water.

GEREEDSCHAPPEN EN UITRUSTING

Veiligheidskleding (veiligheidsschoenen, veiligheidshandschoenen, veiligheidsbril, helm et)

Waterpas

Meetlat

Trapladder (hoogte ca. 1,5 m)

Schroef- of ratelsleutel

Accuschroef- en boormachine met verschillende hulpstukken

Schroevendraaier

Afdichtmateriaal

(niet inbegrepen)

NL



AFVOER VAN DE VERPAKKING

Voer de verpakkingsonderdelen gescheiden af.

Doe papier en karton bij het oud papier en doe folie in de betreffende recyclingbak.

AFVOER VAN DE GEREEDSCHAPSSCHUUR

Let bij het afvoeren van de gereedschapsschuur op de afvoerrichtlijnen, -wetten en -bepalingen voor uw land of regio.

AFMETINGEN

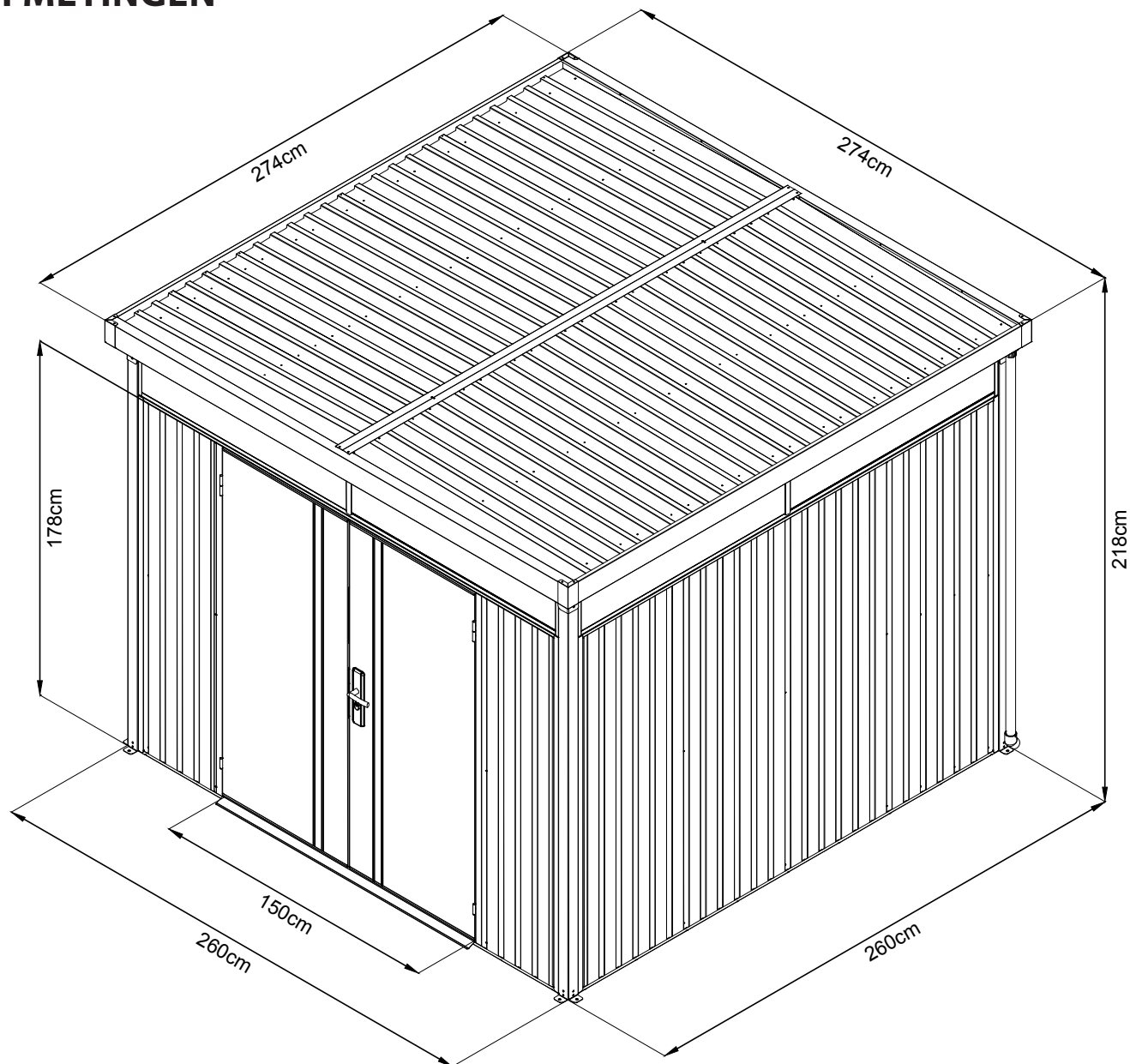

NL

TOELICHTING BIJ DE SYMBOLEN



Montage met/zonder vloerframe ?

+ ?



Montage met vloerframe



Montage zonder vloerframe



Sluitringkap geopend laten/openen





























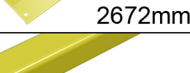





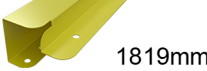

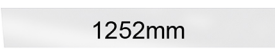
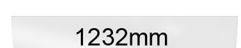

Sluitringkap sluiten

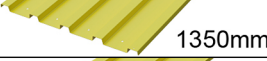
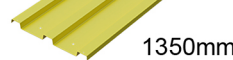
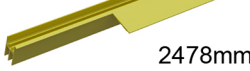

Breng roestbescherming aan op de snijrand

















ONDERDELENLIJST

NR.	ONDERDEEL	HOEVEELHEID
K2		4
K9	 2604mm	2
K4		4
K8	 2444mm	2
K7	 2059mm	4
13	 2542mm	2
K16		4
K17		4
KQ	 2520mm	4
C3	 2495mm	4
1	 2481mm	4
1-1	 2481mm	4
22	 2649mm	2
21	 1000mm	2
5	 1490mm	1
6	 1490mm	1
20	 2736mm	2
17L	 2737mm	1
17R	 2737mm	1
14-1	 2672mm	1
G9	 1990mm	2
G5	 60mm	2









NR.	ONDERDEEL	HOEVEELHEID
14	 2720mm	1
7	 1819mm	8
4	 1819mm	2
P7	 1252mm	4
P8	 1232mm	4
P1	 1819mm	12
P2	 1819mm	2
P5	 1350mm	2
P6	 1350mm	2
P10	 1350mm	4
P9	 1350mm	16
C1	 2478mm	8
C9	 194mm	4
C10	 210mm	8
GC	 120mm	4
G11		2
M1		2
M3		2
C21		4

ONDERDELENLIJST

NR.	ONDERDEEL	HOEVEELHEID
D1	 1770mm	1
D2	 1770mm	1
SX		1
YS		1
SX1	 75mm	1

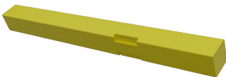
NR.	ONDERDEEL	HOEVEELHEID
F1	 ST4.2*10	500
F2	 M4*10	60
F3	 M5*12	26
F5		34
F6		22
S2		120
S3		120
S4		190
F4		10
C20		4
G1		4
B6		4
QD8		4
M8		4
G3		2
FS		2
FS1		4

ONDERDELENLIJST

NR.	ONDERDEEL	HOEVEELHEID
BW		1
BN		1
BD		2
HZ1		1
HZ2		1
FG		1
FG1		2
FG2		2
FG3		2

MONTAGEOVERZICHT

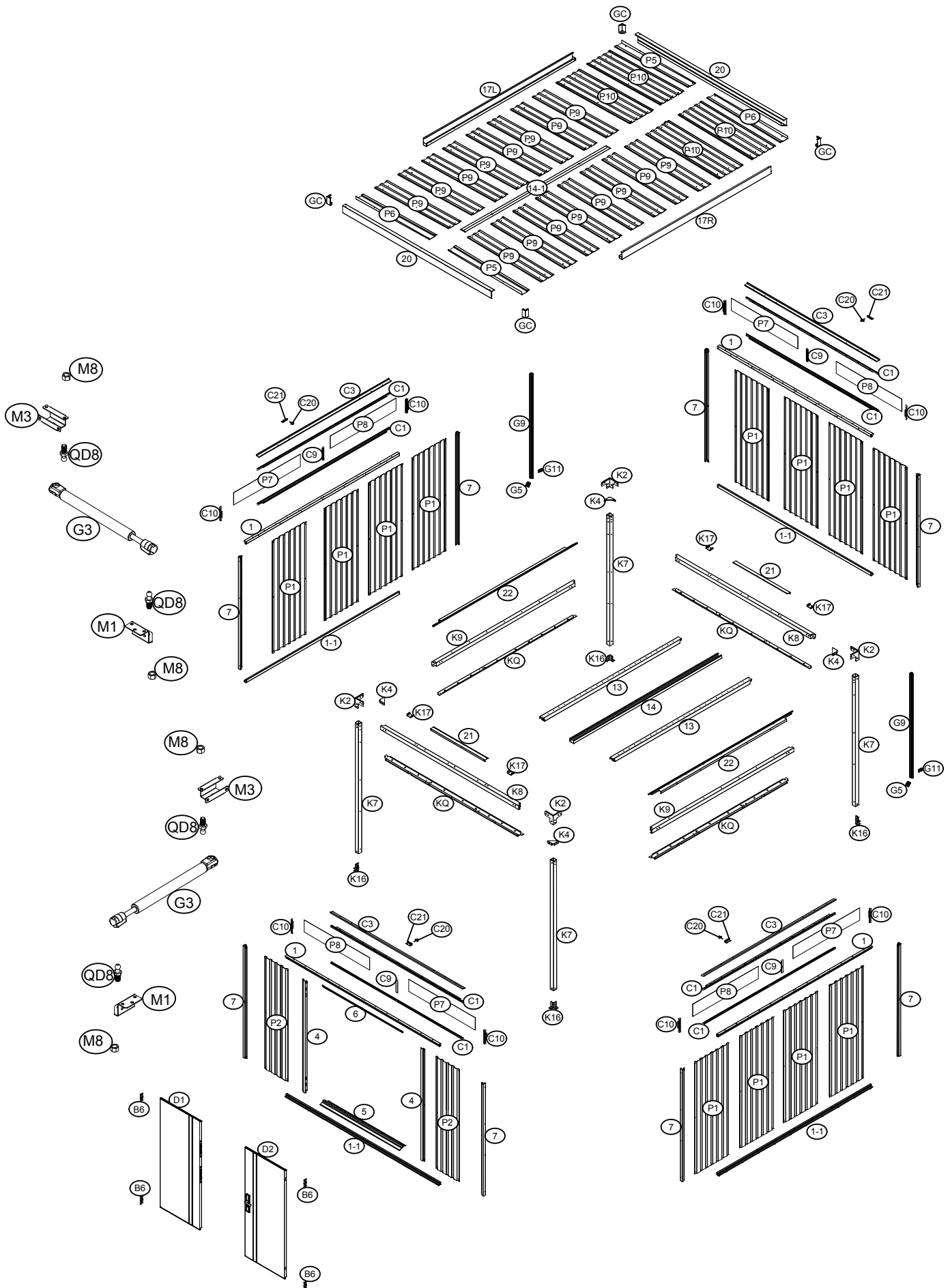

PRAKTISCHE ACCESSOIRES – OPTIONEEL VERKRIJGBAAR

vloerframe
Art. nr. 018011

2. Montage en plaatsing van het huis op het vloerframe.



1. Montage en plaatsing van het vloerframe.

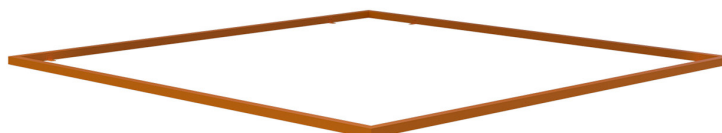

NL

Aluminium vloerpanelen
Art. nr. 018012

Wij adviseren 4 cm dikke XPS-panels als onderconstructie. (niet meegeleverd).

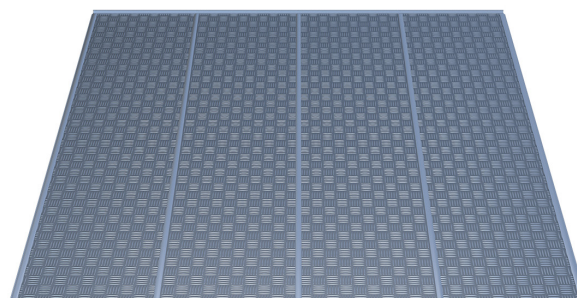

PRÉMIUM RENDSZERHÁZRA A TETŐABLAKKAL Q7,5 FIRSTLINE SZERELÉSI ÚTMUTATÓ

Méret: H x Szé x Ma 274 x 274 x 218 cm



HU

RENDELTETÉSSZERŰ HASZNÁLAT:

Ez a szerszámtároló ház kültéri használatra készült, és a kerti szerszámok, készülékek tárolására szolgál. Nem alkalmas emberek vagy állatok elhelyezésére, illetve veszélyes anyagok tárolására.

A szerszámtároló ház nem alkalmas kereskedelmi célú használatra. A szerszámtároló ház bármilyen ettől eltérő alkalmazása vagy módosítása szakszerűtlen használatnak minősül és jelentős károkat okozhat.

ÉRTESÍTÉS:

Olvassa el figyelmesen a szerelési útmutatót, mielőtt hozzáfog a kerti fészert összeszereléséhez.

Ez különösen érvényes a biztonsági utasításokra.

Ellenkező esetben megsérülhet vagy megrongálhatja a fészert.

A kerti fészert nem gyerekek részére szánt mászóka és nem kúszórács. Fennáll a túlterhelés veszélye.

Győződjön meg arról, hogy minden szükséges szerkezeti elem a megadott mennyiségben áll rendelkezésre.

Az összeszerelés lépéseit egymás után és a megadott sorrendben hajtsa végre a jelen útmutatóban megadottak szerint.

A megadott lépések egyikét se ugorja át vagy rövidítse le.

Ahhoz, hogy későbbi időpontban elővehesse, őrizze meg biztonságos helyen a szerelési útmutatót.

Tervezze meg a felépítést! Padlókeret használata esetén először ezt kell összeszerelni.

ÁLTALÁNOS INFORMÁCIÓK:

Az összeszerelés megkezdése előtt győződjön meg arról, hogy betartja a megfelelő irányelveket/törvényeket.

Az összeszereléshez legalább 300 - 360 perccel számoljon.

Az összeszereléshez legalább 4 személy szükséges. A munkavégzés megkezdése előtt ellenőrizze, hogy minden alkatrész megfelelő mennyiségben áll-e rendelkezésre. Az összeszerelést szabad, napos felületen végezze, ahol nem állnak ki ágak.

Az összeszerelés megkezdése előtt ellenőrizze az egyes szerkezeti elemek épségét, és úgy helyezze el azokat, hogy a szerkezeti elemeket könnyen elérje a munkavégzés során.

A legjobb, ha az apró alkatrészeket, például a csavart, anyát stb. egy tálban tárolja, hogy ne vesszenek el.

A kerti fészter semmi esetre se használja kúszórácsként hüvelyesek, futó- és kúszónövények, gyümölcs, zöldség esetén vagy ruhaszárító kötél tartójaként.

Szabadítsa meg a kerti fészter a hótól és a lombtól. **A legnagyobb teherbírás 150 kg/m².**

A kerti fészter kizárólag a jelen szerelési útmutatóban leírtak szerint használja.

A gyártó vagy a kereskedő nem vállal felelősséget olyan károkért, amelyek a rendeltetésellenes vagy hibás használat miatt következnek be. Ne állítsa a kerti fészter közvetlenül a fűre vagy egyenetlen talajra, gondoskodjon a megfelelő teherbíró képességgel rendelkező vízszintes és stabil aljzatról. Javasoljuk, hogy rögzítse a kerti fészter szilárdan a talajhoz. Győződjön meg arról, hogy minden csavart szilárdan meghúzott és helyes irányban és vízszintesen áll a keret. Ellenőrizze rendszeresen, hogy szilárdan meghúzott minden csavart és szükség esetén húzza után azokat.

Némely fém alkatrészt védőfóliával láttunk el. Ezt a fóliát a szerelés megkezdése előtt el kell távolítani.

BIZTONSÁGI UTASÍTÁSOK:

Soha ne álljon közvetlenül a tetőfelületre, mert fennáll a túlterhelés veszélye. Még összeszerelés és tisztítás közben sem. Gyerekek és korlátozott fizikai, érzékszervi vagy mentális képességekkel rendelkező személyek (pl. túlságosan fáradt személyek, részben fogyatékos személyek, csökkent fizikai és szellemi képességgel rendelkező idősebb személyek) esetén vagy tapasztalat és tudás hiányában (pl. idősebb gyerekek) veszély áll fenn. A kerti fészter szereléséhez apró alkatrészek, például csavarok és anyák használatosak, amelyek lenyeléskor fulladásveszélyt okozhatnak.

A kerti fészter kizárólag szakavatott személy építheti fel, gyerekek vagy korlátozott szellemi és motorikus képességű vagy kevés tapasztalattal rendelkező személyek nem.

A kerti fészter nem szakszerű használata sérüléshez vagy anyagi kárhoz vezethet.

Vigyázzon az egyes szerkezeti elemek csomagolásból való kicsomagolásakor. **Az éles élek mentén balesetveszély áll fenn.** Az egyes szerkezeti elemek fémből vannak, ezért nehezek. Ha nem óvatosan nyitja ki a csomagolást, például

éles késsel vagy egyéb éles/hegyes tárggyal fennáll a veszélye, hogy megséríti a szerkezeti elemet. A részegységek kicsomagolását követően ellenőrizze, hogy minden szerkezeti elem megfelelő mennyiségben áll-e rendelkezésre.

A bevonat karcolásának megakadályozása érdekében helyezze az egyes alkatrészeket egy takaróra vagy hasonlóra. Ellenőrizze, hogy az egyes szerkezeti elemek kifogástalan állapotúak vagy sérültek-e. Ha igen, ne használja a sérült, deformált szerkezeti elemeket.

Az összeszerelés és a szerelés során mindig viseljen biztonsági ruházatot. Az alapfelszereléshez tartozik a biztonsági lábbeli, védőkesztyű, védőszemüveg és a sisak.

Ne erősen szeles vagy esős napon állítsa fel a kerti fészter.

Győződjön meg arról, hogy a szerkezeti elemek nem érintkeznek elektromos vezetékkel.

A csomagolást, műanyag tasakot vagy a védőfóliát szakszerűen ártalmatlanítsa és tartsa azokat gyerekektől távol, fulladásveszély!

A kerti fészter egyenes felületre állítsa.

Győződjön meg arról, hogy az összeszerelés során ne tartózkodjanak gyerekek a veszélyzónában.

Ne helyezze a kerti fészter olyan területekre, ahol azt erős vagy folyamatos szél éri.

Személyes biztonsága érdekében ne szerelje össze a kerti fészter, ha fáradt, alkoholt fogyasztott vagy kábítószer hatása alatt áll stb., illetve ha úgy érzi, szédül vagy rosszul érzi magát.

Ha létrát vagy elektromos készüléket használ, győződjön meg arról, hogy betartja a felhasználásra vonatkozó gyártói adatokat. A tűzveszély miatt forró készülékek, például grillsütő, fűtőkészülékek stb. nem használhatók vagy tárolhatók a fészterben! Rossz idő vagy zivatar esetén soha ne álljon a fészterbe vagy a fészter mellé. Fennáll a villámcsapás veszélye.

ÁPOLÁS ÉS ÁLLAGMEGÓVÁS:

Tisztítsa meg rendszeresen a felületet. Amennyiben a felületen karcolást észlel, megfelelő lakk segítségével azonnal távolítsa el azt.

Ne használjon maró tisztítószer, fém- vagy nejlonsörtéjű kefét, valamint éles vagy fém segédeszközt, például kést vagy spatulát. Tisztításhoz puha sörtét használjon. Használjon hideg, tiszta vizet.

SZERSZÁM ÉS FELSZERELÉS:

Biztonsági ruházat (biztonsági lábbeli, védőkesztyű, védőszemüveg, kobak stb.)

Vízmérték

Hosszmérő

Kétágú létra (kb. 1,5 m magas)

Csavar- vagy racsnis kulcsot

Akkumulátoros csavarhúzó és fúrógép különböző rátétel

Csavarhúzó

Tömítőanyag

(nem tartozik a készülékhez mellékelt tartozékok közé)

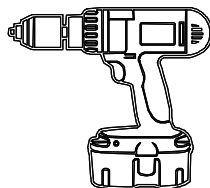
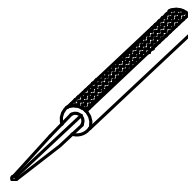
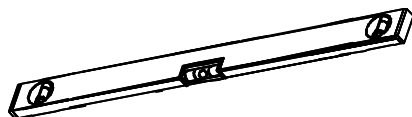
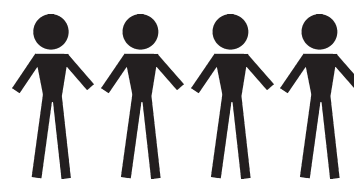

HU

A CSOMAGOLÁS ÁRTALMATLANÍTÁSA:

A csomagolást fajtánként szétválogatva ártalmatlanítsa.

A hullámpapír és a kartonpapír ártalmatlanítása papírhulladékként, és a fóliát vigye a megfelelő gyűjtőhelyre

A FÉSZER ÁRTALMATLANÍTÁSA:

A fészert ártalmatlanításánál ügyeljen az Ön országában vagy tartományában az ártalmatlanításra vonatkozóan érvényes irányelvekre, törvényekre és rendelkezésekre.

MÉRETEK

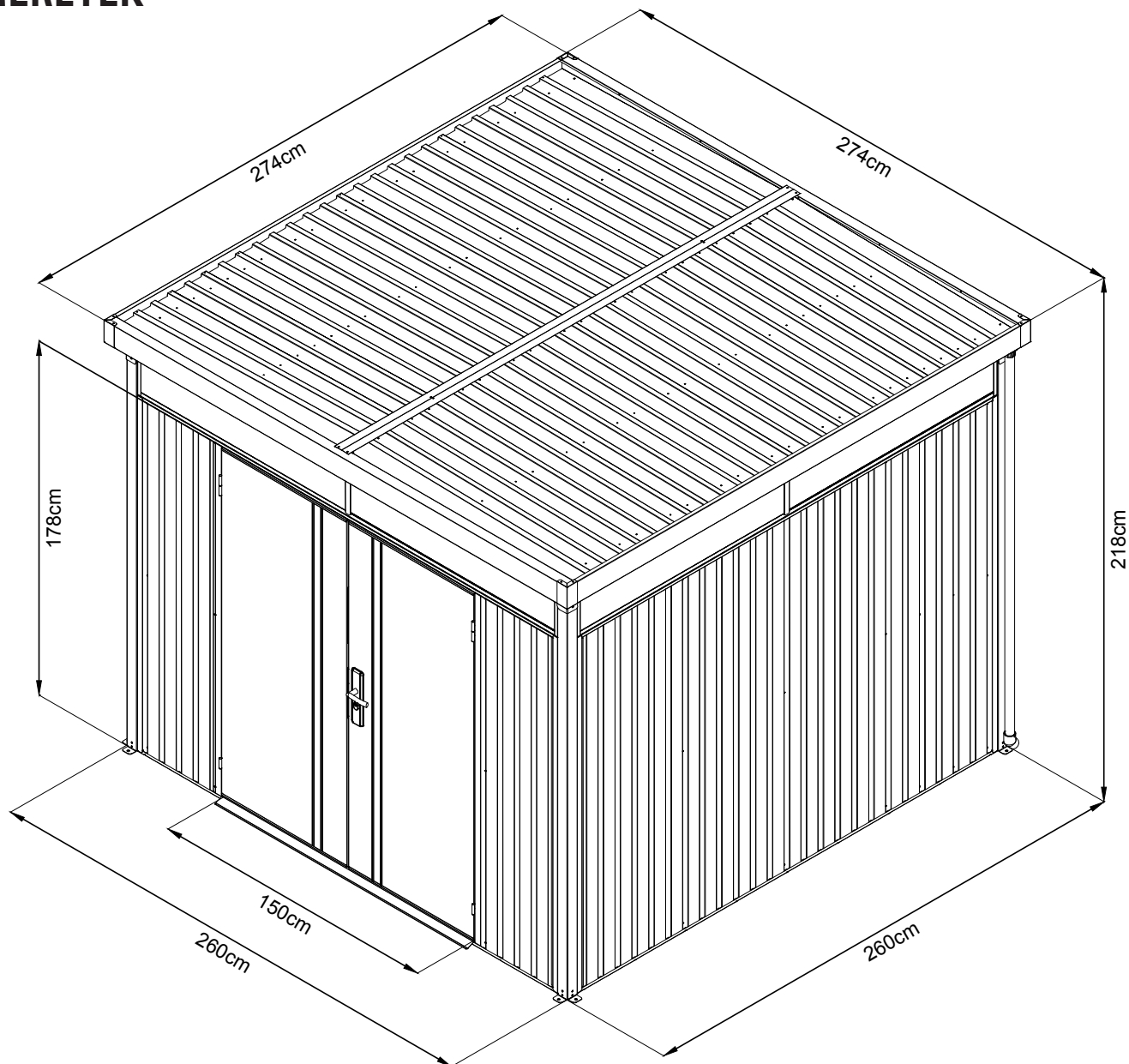

HU

SZIMBÓLUMOK MAGYARÁZATA



Összeszerelés padlókerettel/
Összeszerelés padlókeret
nélkül ?



Összeszerelés padlókerettel

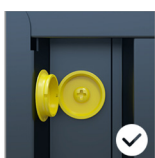

Hagyja nyitva az ablakmosó
sapkáját



Összeszerelés padlókeret nélkül



























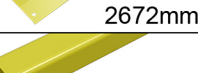





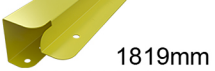

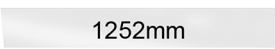
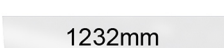

Zárja le az ablakmosó
sapkáját

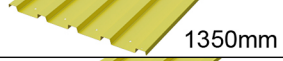

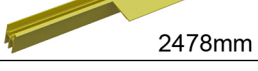
Vigye fel a rozsdagátlót
a vágott szélre





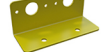





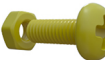



ALKATRÉSZLISTA

SZ.	ALKATRÉSZ	MENNYISÉG
K2		4
K9	 2604mm	2
K4		4
K8	 2444mm	2
K7	 2059mm	4
13	 2542mm	2
K16		4
K17		4
KQ	 2520mm	4
C3	 2495mm	4
1	 2481mm	4
1-1	 2481mm	4
22	 2649mm	2
21	 1000mm	2
5	 1490mm	1
6	 1490mm	1
20	 2736mm	2
17L	 2737mm	1
17R	 2737mm	1
14-1	 2672mm	1
G9	 1990mm	2
G5	 60mm	2

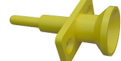
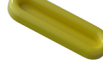

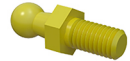



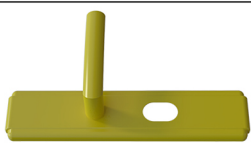

SZ.	ALKATRÉSZ	MENNYISÉG
14	 2720mm	1
7	 1819mm	8
4	 1819mm	2
P7	 1252mm	4
P8	 1232mm	4
P1	 1819mm	12
P2	 1819mm	2
P5	 1350mm	2
P6	 1350mm	2
P10	 1350mm	4
P9	 1350mm	16
C1	 2478mm	8
C9	 194mm	4
C10	 210mm	8
GC	 120mm	4
G11		2
M1		2
M3		2
C21		4

ALKATRÉSZLISTA

SZ.	ALKATRÉSZ	MENNYISÉG
D1	 1770mm	1
D2	 1770mm	1
SX		1
YS		1
SX1	 75mm	1

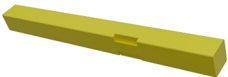
SZ.	ALKATRÉSZ	MENNYISÉG
F1	 ST4.2*10	500
F2	 M4*10	60
F3	 M5*12	26
F5		34
F6		22
S2		120
S3		120
S4		190
F4		10
C20		4
G1		4
B6		4
QD8		4
M8		4
G3		2
FS		2
FS1		4

ALKATRÉSZLISTA

SZ.	ALKATRÉSZ	MENNYISÉG
BW		1
BN		1
BD		2
HZ1		1
HZ2		1
FG		1
FG1		2
FG2		2
FG3		2

SZERELÉS ÁTTEKINTÉSE

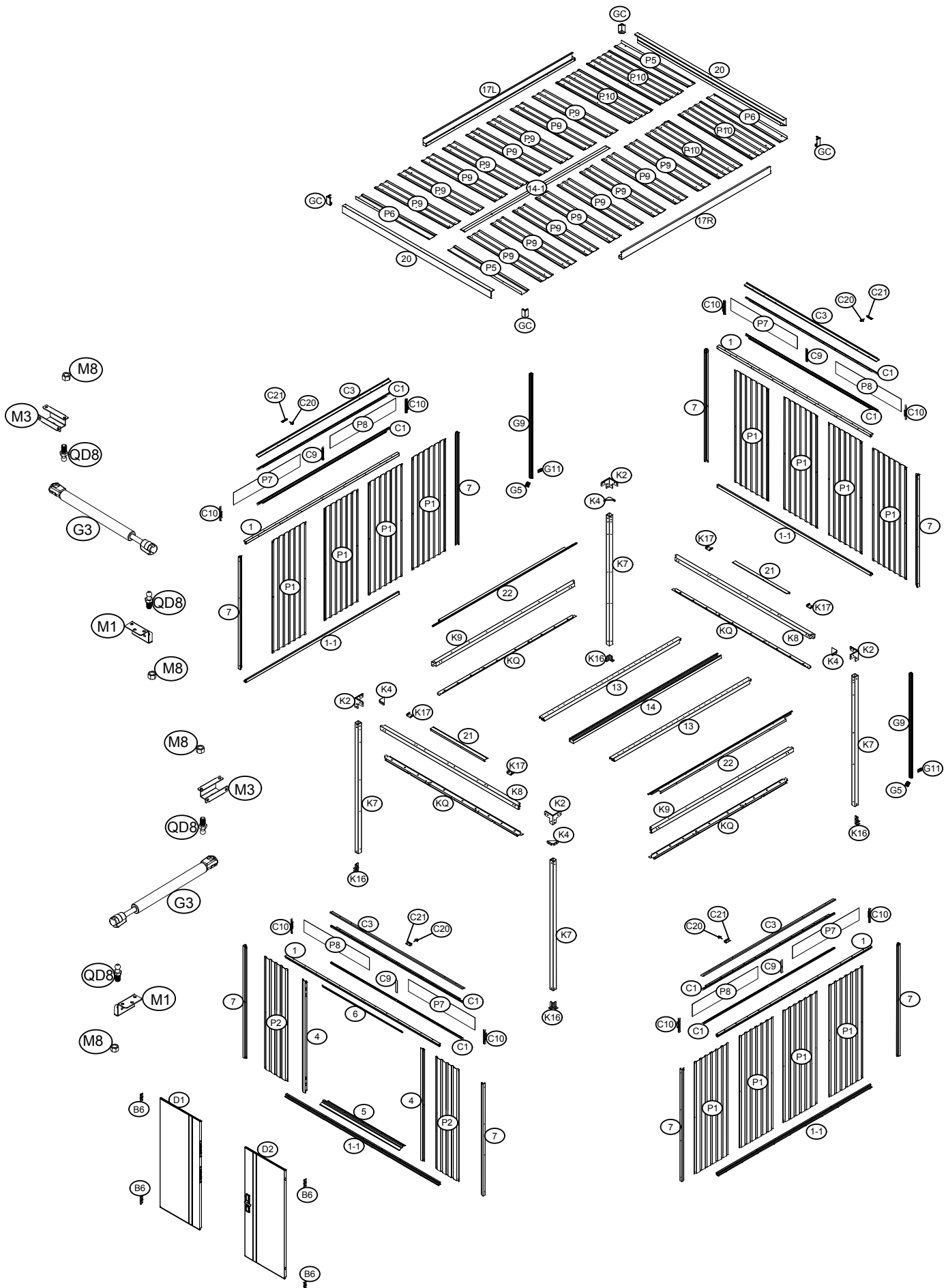

PRAKTIKUS TARTOZÉK – OPCIONÁLISAN ELÉRHETŐ

Padlókeret
cikkszám. 018011

**2. A ház összeszerelése
és elhelyezése a
padlókereten.**



**1. A padlókeret
összeszerelése
és elhelyezése.**

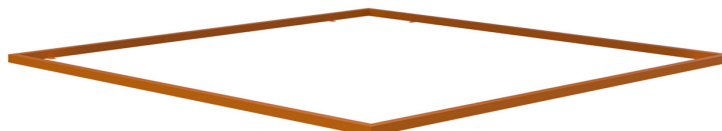

HU

Alumínium padló lemezek
cikkszám. 018012

Lábatként 4 cm-es vastagú XPS lemezeket ajánlunk.
(ezeket az egységcsomag nem tartalmazza)

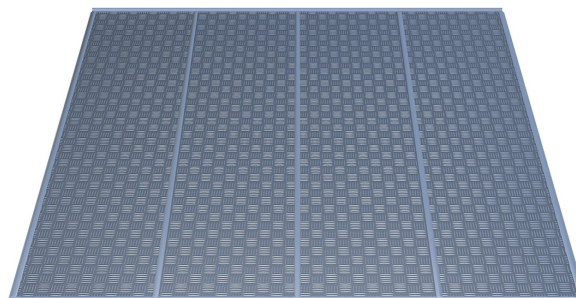

PREMIUM MAGAZIE CU LUMINĂ SUPERIOARĂ 7,5 FIRSTLINE INSTRUCȚIUNI DE ASAMBLARE

Dimensiuni: L x l x H 274 x 274 x 218 cm



RO

UTILIZARE CONFORM DESTINAȚIEI PREVĂZUTE

Magazia este concepută pentru utilizare în exterior și servește la depozitarea uneltelor pentru grădinărit, a aparatelor și a ustensilelor. Nu este destinată adăpostirii oamenilor sau animalelor și nici depozitării de substanțe periculoase. Magazia nu este adecvată pentru uz comercial. Orice altă utilizare sau modificare a magaziei este considerată utilizare necorespunzătoare și poate cauza pericole semnificative.

INDICAȚIE

Citiți cu atenție instrucțiunile de asamblare înainte de a începe asamblarea magaziei.

Se aplică în special instrucțiunilor de siguranță.

Altfel, vă puteți răni sau puteți deteriora dispozitivul.

Magazia nu este un obiect pe care se pot cățăra copiii și nici scară. Există riscul de răsturnare.

Asigurați-vă că toate piesele componente sunt disponibile în cantitatea prevăzută.

Urmați pașii de asamblare individuali și în ordinea corectă, așa cum sunt precizate în aceste instrucțiuni.

Vă rugăm să nu omiteți niciun pas și să nu scurtați succesiunea lor.

Păstrați instrucțiunile de asamblare într-un loc sigur, pentru a le putea recupera cu ușurință mai târziu.

Planificați montarea! La utilizarea unei cadru de podea acesta trebuie montat mai întâi.

INFORMAȚII GENERALE

Înainte de a începe montajul, asigurați-vă că sunt respectate directivele/legile aplicabile pentru dumneavoastră. Planificați între 300 și 360 de minute pentru montaj.

Sunt necesare minim 4 persoane. Înainte de începerea lucrului, verificați dacă toate piesele sunt disponibile în cantitatea corectă. Folosiți o suprafață liberă, înșorită, fără crengi deasupra, pentru montaj.

Verificați piesele individuale înainte de începerea montajului, pentru integritate, și așezați-le astfel încât să fie ușor de luat în timpul lucrului.

Se recomandă păstrarea pieselor mici, precum șuruburile, piulițele etc. într-o cutie, pentru a evita pierderea acestora. Nu folosiți în niciun caz magazia ca suport pentru legume, plante agățătoare sau în ghiveci și fructe, și nici ca uscător pentru haine.

Nu permiteți magaziei să fie acoperită de zăpadă și frunze. **Capacitatea portantă max. este de 150 kg/m².**

Utilizați magazia exclusiv conform descrierii din aceste instrucțiuni pentru montaj.

Producătorul sau comerciantul nu își asumă răspunderea pentru daune survenite în urma utilizării neconforme sau greșite. Nu așezați magazia direct pe iarbă sau pe un teren denivelat.

Asigurați-vă că solul este adecvat, portant, orizontal și stabil. Recomandăm ancorarea sigură a magaziei în pământ.

Asigurați-vă că toate șuruburile sunt strânse și că rama este corect orientată și orizontală. Verificați regulat că toate șuruburile sunt strânse bine și ajustați-le dacă este necesar.

Unele componente metalice sunt prevăzute cu o folie de protecție. Această folie trebuie să fie îndepărtată cu grijă înainte de începerea montajului.

INDICAȚII DE SIGURANȚĂ

Nu vă așezați niciodată direct pe acoperiș, există pericolul de a-l suprasolicita. Valabil și în timpul montajului sau curățării.

Există un pericol pentru copii și persoanele cu capacități fizice, senzoriale sau mentale reduse (de ex. persoane extenuate, cu dizabilități parțiale, cu vârste înaintate și capacități fizice și mentale reduse) sau cu experiență și cunoștințe reduse (de ex. copii mai mari). La montajul magaziei se folosesc piese mici, cum ar fi șuruburile și piulițele, care prezintă risc de înghițire și sufocare.

Magazia se poate construi doar de către persoane cu expertiză suficientă, nu de către copii sau persoane cu capacități spirituale sau motrice reduse, sau cu o experiență redusă.

Manevrarea inadecvată a magaziei poate provoca răniri sau deteriorări ale obiectelor.

Când despachetați piesele componente individuale, atenție la ambalaj. **Există un pericol de rănire generat de muchiile ascuțite.** Piesele individuale sunt confecționate din metal și sunt grele. În cazul deschiderii neglijente a ambalajului, de exemplu folosind un cuțit ascuțit sau un alt obiect ascuțit/tăios prezintă pericolul de a deteriora piesele componente. După despachetare, verificați dacă toate piesele individuale sunt în cantitatea corespunzătoare. Așezați piesele individuale pe o suprafață plană, pentru a evita zgârierea.

Verificați dacă piesele individuale sunt în stare bună sau dacă prezintă deteriorări, caz în care vă rugăm să nu folosiți piesele deteriorate sau deformat.

În timpul asamblării și montajului, vă rugăm să purtați permanent îmbrăcăminte de protecție. Echipamentul de bază include încălțăminte de siguranță, mănuși, ochelari de protecție și cască.

Nu instalați magazia în zile cu mult vânt sau ploioase.

Asigurați-vă că piesele componente nu ating niciun cablu sub tensiune.

Eliminați corespunzător ambalajul, punga de plastic sau foliile de protecție, și păstrați-le în locuri în care nu au acces copiii. Prezintă risc de sufocare!

Așezați magazia pe o suprafață plată.

Asigurați-vă că, în timpul montajului, nu sunt prezenți copii în zona de pericol.

Nu amplasați magazia în zone care sunt expuse vântului puternic sau de durată.

Pentru siguranța personală, nu construiți magazia când sunteți obosit, ați consumat alcool sau sunteți în stare de ebrietate, resp. dacă vă simțiți amețit sau vă este rău.

Dacă utilizați cabluri sau dispozitive electronice, asigurați-vă că respectați indicațiile producătorului.

Dispozitivele fierbinț, cum ar fi grătarele, dispozitivele de încălzire, arzătoarele etc. nu se vor folosi în magazie și nici nu vor fi depozitate acolo - pericol de incendiu! Pe vreme rea sau în condiții meteorologie nefavorabile, nu stați în interiorul sau în proximitatea magaziei. Există riscul să fiți lovit de fulger.

ÎNTREȚINERE ȘI ÎNGRIJIRE

Curățați regulat suprafețele. Dacă remarcați zgârieturi pe suprafețe, înlăturați-le imediat folosind un lac corespunzător.

Nu utilizați agenți de curățare agresivi, perii cu fire metalice sau de nailon, nici ustensile ascuțite sau metalice, cum ar fi lame ori spatule. Pentru curățare, folosiți perii moi. Folosiți apă rece, curată.

UNELTE ȘI ECHIPAMENT

Îmbrăcăminte de protecție (mănuși, încălțăminte, ochelari, cască etc.)

Nivelă

Tijă pentru măsurarea lungimii

Scară (cca. 1,5 m înălțime)

Seturi de chei

Șurubelniță electrică și bormașină cu diferite atașamente

Șurubelniță

Material pentru etanșare

(nu sunt incluse în pachet)

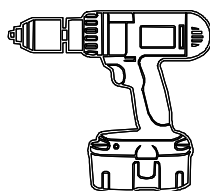
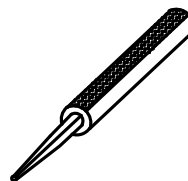
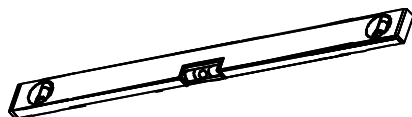
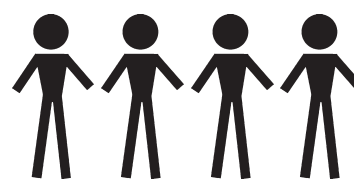

RO

ELIMINAREA AMBALAJULUI

Eliminați corespunzător ambalajul.

Cartonul și hârtia se elimină ca hârtie veche, iar pentru folii puteți apela la centrele de reciclare.

ELIMINAREA MAGAZIEI

La eliminarea magaziei, vă rugăm să respectați directivele, legile și reglementările aplicabile în țara sau în regiunea dumneavoastră.

DIMENSIUNI

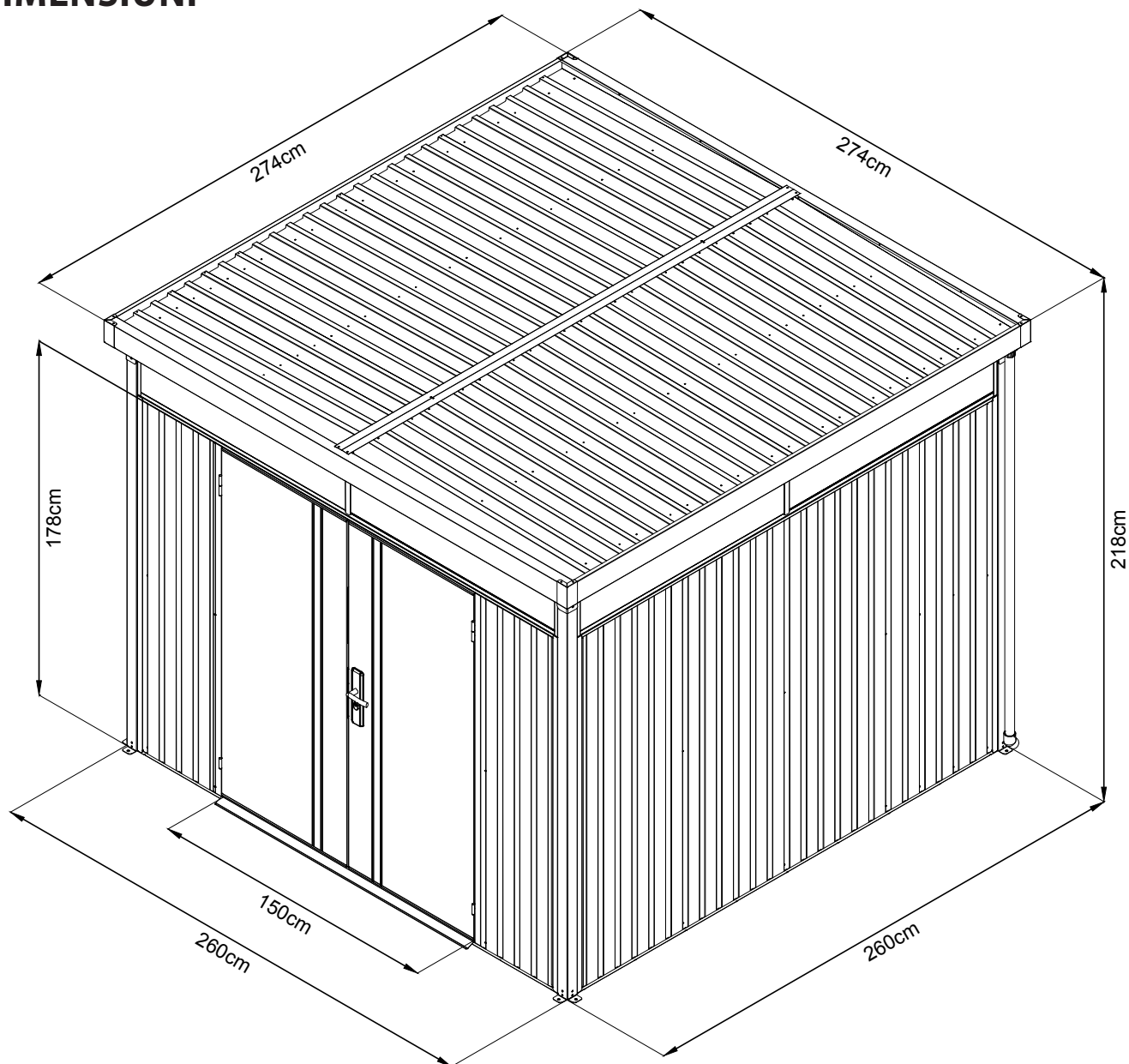

RO

EXPLICAREA SIMBOLURILOR



Montare cu/ fără
cadru de podea ?



Montare cu cadru de podea



Lăsarea capacului cu șaibe de
siguranță deschis / deschiderea
capacului șaibe de siguranță



Montare fără cadru de podea





























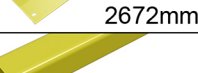





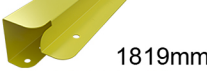

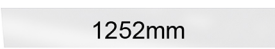
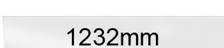



Închiderea capacului cu șaibe
de siguranță

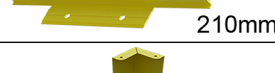

folosiți protecție anti-rugină
pe marginea tăioasă















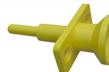

LISTĂ DE PIESE

NR.	PIESĂ	CANTITATE
K2		4
K9	 2604mm	2
K4		4
K8	 2444mm	2
K7	 2059mm	4
13	 2542mm	2
K16		4
K17		4
KQ	 2520mm	4
C3	 2495mm	4
1	 2481mm	4
1-1	 2481mm	4
22	 2649mm	2
21	 1000mm	2
5	 1490mm	1
6	 1490mm	1
20	 2736mm	2
17L	 2737mm	1
17R	 2737mm	1
14-1	 2672mm	1
G9	 1990mm	2
G5	 60mm	2







NR.	PIESĂ	CANTITATE
14	 2720mm	1
7	 1819mm	8
4	 1819mm	2
P7	 1252mm	4
P8	 1232mm	4
P1	 1819mm	12
P2	 1819mm	2
P5	 1350mm	2
P6	 1350mm	2
P10	 1350mm	4
P9	 1350mm	16
C1	 2478mm	8
C9	 194mm	4
C10	 210mm	8
GC	 120mm	4
G11		2
M1		2
M3		2
C21		4

LISTĂ DE PIESE

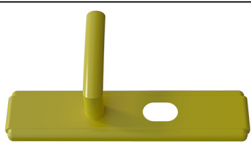
NR.	PIESĂ	CANTITATE
D1	 1770mm	1
D2	 1770mm	1
SX		1
YS		1
SX1	 75mm	1

NR.	PIESĂ	CANTITATE
F1	 ST4.2*10	500
F2	 M4*10	60
F3	 M5*12	26
F5		34
F6		22
S2		120
S3		120
S4		190
F4		10
C20		4
G1		4
B6		4
QD8		4
M8		4
G3		2
FS		2
FS1		4

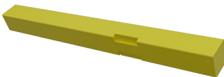
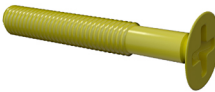
LISTĂ DE PIESE

NR.	PIESĂ	CANTITATE
BW		1
BN		1
BD		2
HZ1		1
HZ2		1
FG		1
FG1		2
FG2		2
FG3		2

PRIVIRE DE ANSAMBLU MONTAJ

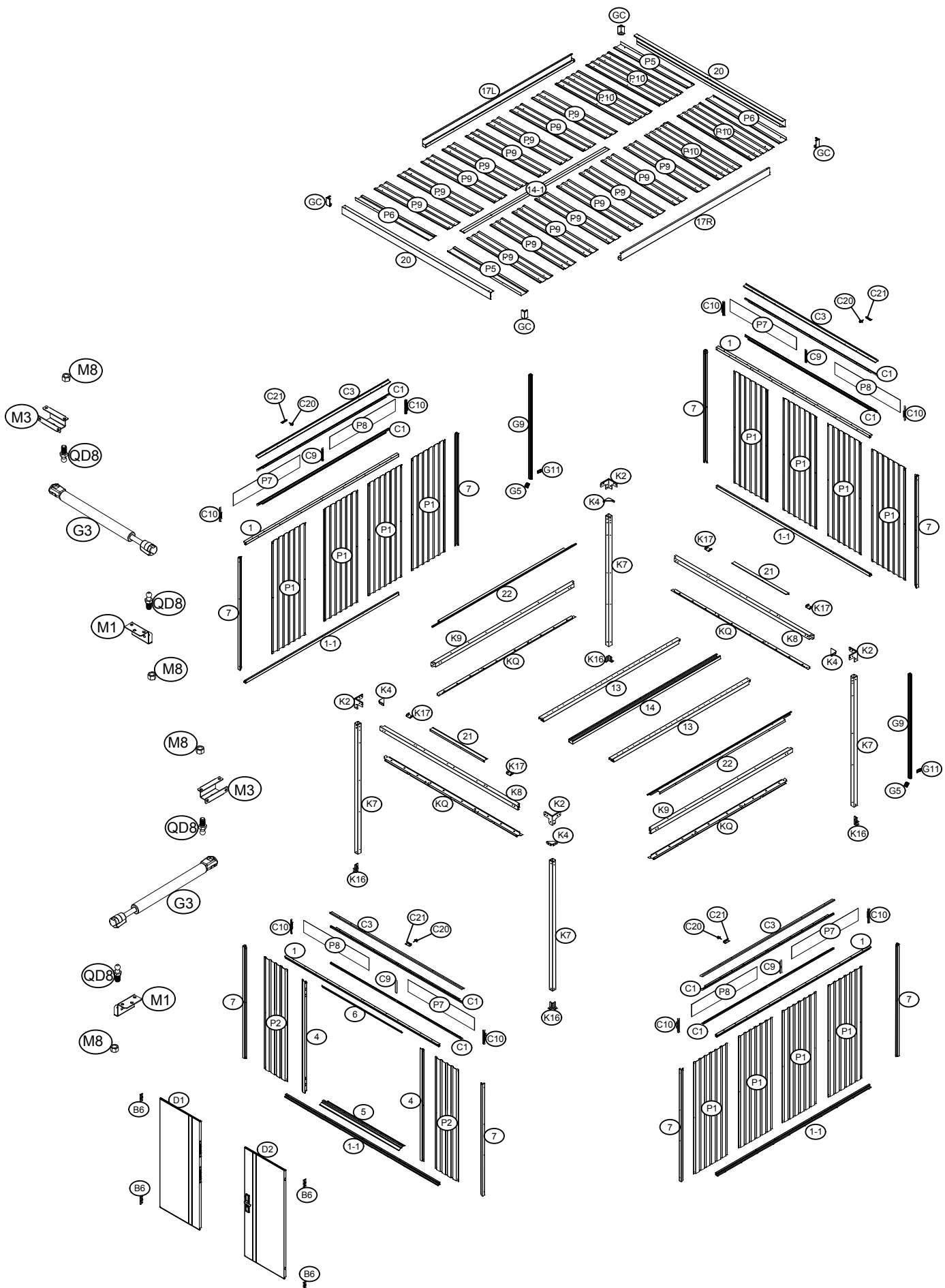

ACCESORII PRACTICE - DISPONIBILE OPȚIONAL

Cadru de podea
Nr. art. 018011

**2. Montarea și
amplasarea magaziei
pe cadrul de podea.**



**1. Montarea și
amplasarea cadrului
de podea.**

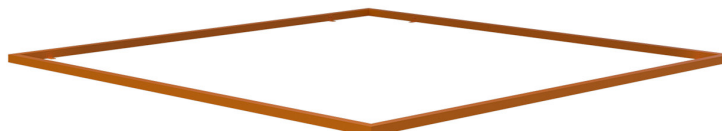

RO

Plăci de podea din aluminiu
Nr. art. 018012

Ca substructură vă recomandăm plăci XPS de 4 cm grosime. (nu sunt incluse în pachetul de livrare)

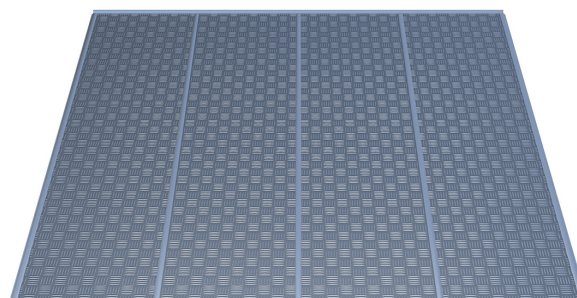

VRHUNSKI VRTNO UTO Z NADSVETLOBO Q7,5 FIRSTLINE NAVODILA ZA SESTAVLJANJE

Mere: D × Š × V: 274 x 274 x 218 cm



SL

PRAVILNA UPORABA:

Hiša za orodje je zasnovana za zunanjo uporabo in se uporablja za shranjevanje vrtnega orodja, opreme in pripomočkov. Ni primerna za bivanje ljudi ali živali ali za shranjevanje nevarnih snovi. Hiša za orodje ni primerna za komercialno uporabo. Kakršna koli druga raba ali spreminjanje hiše za orodje se šteje za nepravilno uporabo in lahko povzroči veliko nevarnost.

NAPOTEK:

Skrbno preberite navodila za sestavljanje, preden začnete s sestavljanjem vrtno lopa.

To še zlasti velja za varnostne napotke.

V nasprotnem primeru lahko poškodujete sebe ali vrtno lopa.

Vrtna lopa ni plezalno ogrodje za otroke in ogrodje za rast rastlin. Obstaja nevarnost preobremenitve.

Prepričajte se, da so vsi potrebni sestavni deli na voljo v navedenih količinah.

Posamezne korake sestavljanja izvajajte zaporedoma in v navedenem vrstnem redu, kot je navedeno v teh navodilih.

Nobenega od navedenih korakov ne izpustite ali ga skrajšajte.

Navodila za sestavljanje hranite na varnem mestu, da lahko do njih znova dostopate v prihodnosti.

Načrtujte sestavljanje! Pri uporabi talnega okvirja je treba tega najprej namestiti.

SPLOŠNE INFORMACIJE:

Preden začnete z montažo, se prepričajte, da so upoštewane zadevne smernice/zakoni. Za montažo načrtujte vsaj od 300 do 360 minut.

Za montažo so potrebne vsaj 4 osebe. Pred začetkom dela se prepričajte, da so prisotni vsi deli, in sicer v pravih količinah. Za sestavljanje uporabite sončno površino na prostem, nad katero ni vej.

Pred začetkom montaže preglejte posamezne sestavne dele glede nepoškodovanosti in jih odložite tako, da je med delom do sestavnih delov mogoče dostopati brez težav.

Najbolje je, če majhne dele, kot so vijaki, matice itd., hranite v posodi, tako da jih ne izgubite.

Vrtno lopa nikakor ne uporabljajte kot oporo za stročnice, plezalke in ovijalke, sadje, zelenjavo ali kot držalo za vrv za perilo.

Poskrbite, da na vrtni lopa ni snega in listja. **Najv. nosilnost je 150 kg/m².**

Vrtno lopa uporabljajte izključno tako, kot je opisano v teh navodilih za montažo.

Proizvajalec ali trgovec ne prevzema nobene odgovornosti za škodo, ki nastane zaradi nenamenske ali nepravilne uporabe. Vrtno lopa ne postavljajte neposredno na trato ali neravne podlage ter poskrbite za primerno, vzdržljivo, vodoravno in stabilno podlago. Priporočamo, da vrtno lopa zasidrate trdno v tla. Prepričajte se, da so vsi vijaki trdno priviti in da je ogrodje pravilno usmerjeno in vodoravno. Redno preverjajte, ali so vsi vijaki trdno priviti in jih po potrebi dodatno zategnite.

Nekateri kovinski deli so opremljeni z zaščitno folijo. To folijo je treba pred začetkom vgradnje previdno odstraniti.

SL

VARNOSTNI NAPOTKI:

Nikoli ga ne postavljajte neposredno na strešno površino, obstaja nevarnost preobremenitve. Tudi ne v času montaže ali za čiščenje.

Obstaja nevarnost za otroke in osebe z zmanjšanimi fizičnimi, zaznavnimi ali duševnimi sposobnostmi (npr. osebe, ki so pretrujene, delno invalidne osebe, starejše osebe z zmanjšanimi fizičnimi in duševnimi sposobnostmi) ali pomanjkanjem znanja in izkušenj (npr. starejši otroci). Pri montaži vrtno lopa se uporabljajo majhni deli, kot so vijaki in matice, na podlagi česar obstaja nevarnost zadušitve, če se jih zaužije.

Vrtno lopa sme sestavljati le strokovnjak, v postopek pa ne smejo biti vključeni otroci ali osebe z zmanjšanimi duševnimi ali motoričnimi sposobnostmi ali osebe s pomanjkanjem izkušenj.

Zaradi nepravilnega ravnanja z vrtno lopa lahko pride do telesnih poškodb ali materialne škode.

Pri jemanju posameznih sestavnih delov iz embalaže bodite previdni. **Obstaja nevarnost telesnih poškodb zaradi ostrih robov.** Posamezni sestavni deli so izdelani iz kovine in so zaradi tega težki. Pri neprevidnem odpiranju embalaže, npr. z ostrim nožem ali drugim ostrim/koničastim predmetom, obstaja nevarnost poškodb sestavnih delov. Po jemanju sestavnih delov iz embalaže preverite, ali so vsi sestavni deli na voljo v pravih količinah. Posamezne dele odložite na odejo ali podobno podlago, da preprečite raze na premazu.

Preverite, ali so posamezni sestavni deli v brezhibnem stanju, oz. preverite, ali so na njih poškodbe, v primeru česar poškodovanih, deformiranih delov ne uporabljajte.

Med sestavljanjem in montažo nosite vedno varnostna oblačila. Med osnovno opremo sodijo zaščitna obutev, zaščitne rokavice, zaščitna očala in čelada.

Vrtno lopa ne montirajte ob dnevih, ko piha močan veter ali pada dež.

Poskrbite, da se sestavni deli ne dotikajo nobenih električnih kablov.

Embalažo, plastične vrečke ali zaščitne folije pravilno zavrzite in jih hranite zunaj dosega otrok, saj obstaja nevarnost zadušitve.

Vrtno lopa postavite na ravno površino.

Prepričajte se, da med montažo na območju nevarnosti ni otrok.

Vrtno lopa ne postavljajte na območjih, ki so izpostavljena močnim ali stalnim vetrovom.

Zaradi osebne varnosti ne sestavljajte vrtno lopa, če ste utrujeni, pod vplivom alkohola ali mamil oz. če imate vrtoglavico ali se ne počutite dobro.

Če uporabljate lestve ali elektronske naprave, se prepričajte, da upoštevate navedbe posameznih proizvajalcev glede uporabe. Vročih naprav, kot so žari, grelne naprave, gorilniki itd., ni dovoljeno uporabljati v vrtni lopa ali jih v njej skladiščiti, saj obstaja nevarnost požara. V primeru neurja ali viharja se nikoli ne zadržujte v vrtni lopa ali ob njej. Obstaja nevarnost udara strele.

NEGA IN VZDRŽEVANJE:

Površine redno čistite. Če na površinah opazite raze, jih takoj odstranite s primernim lakom.

Ne uporabljajte nobenih agresivnih čistilnih sredstev, krtač s kovinskimi ali najlonskimi ščetinami ter ostrih ali kovinskih predmetov, kot so noži ali lopatice. Za čiščenje uporabljajte krtače z mehкими ščetinami. Uporabljajte hladno, čisto vodo.

ORODJA IN OPREMA:

Varnostna oblačila (zaščitna obutev, zaščitne rokavice, zaščitna očala, čelada itd.)

Vodna tehtnica

Merilnik dolžine

Lestev (visoka pribl. 1,5 m)

Vijačni ključ ali raglja

Akumulatorski izvijač in vrtalnik z razl. nastavki

Izvijač

Tesnilni material

(ni priloženo kompletu)

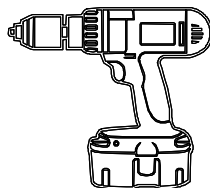
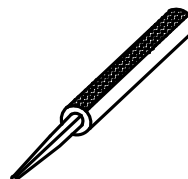
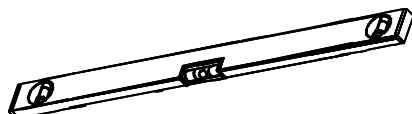

SL

ODLAGANJE EMBALAŽE MED ODPADKE:

Embalažo odložite med odpadke ločeno po vrstah materialov.

Lepenke in karton zavrzite kot odpadni papir, folije

pa oddajte na ustreznem zbirnem mestu.

ODLAGANJE VRTNE LOPA ODPADKE:

Pri odlaganju vrtno lopa med odpadke upoštevajte veljavne smernice, zakone in druge določbe v zvezi z odlaganjem opreme med odpadke v svoji državi ali zvezni državi.

DIMENZIJE

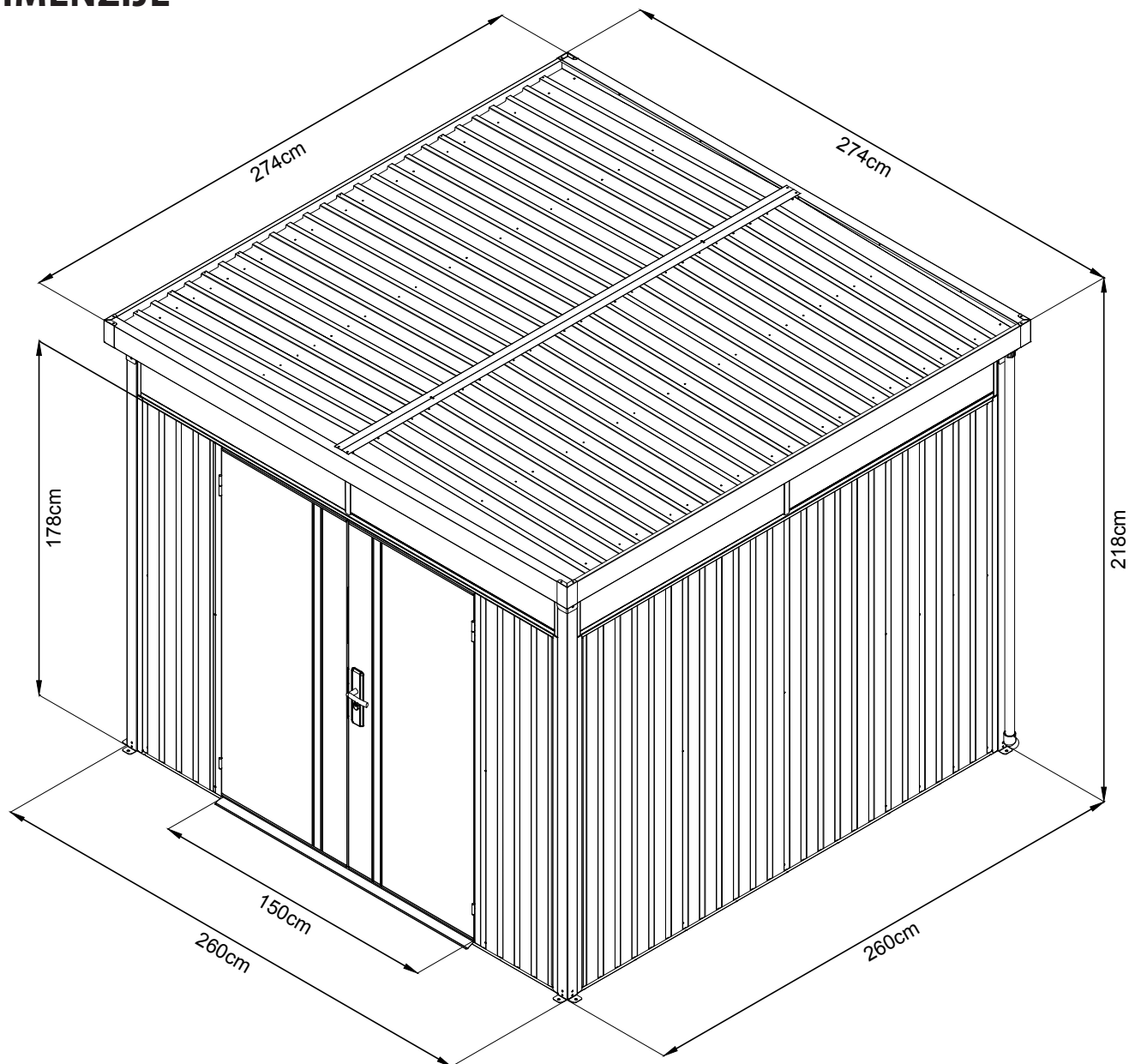

SL

RAZLAGA SIMBOLOV



+ ?



Montaža s/ brez talnim okvirjem ?



Montaža s talnim okvirjem



Montaža brez talnega okvirja

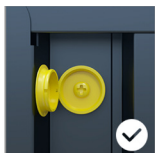

Pustite pokrovček odprt































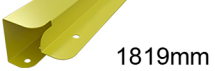

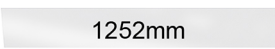
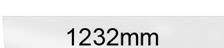

Zaprte pokrovček

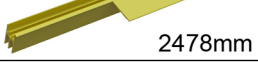

Na rezilo nanesite sredstvo za zaščito proti rjavenju

SEZNAM DELOV



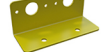













ŠT.	DEL	KOLIČINA
K2		4
K9	 2604mm	2
K4		4
K8	 2444mm	2
K7	 2059mm	4
13	 2542mm	2
K16		4
K17		4
KQ	 2520mm	4
C3	 2495mm	4
1	 2481mm	4
1-1	 2481mm	4
22	 2649mm	2
21	 1000mm	2
5	 1490mm	1
6	 1490mm	1
20	 2736mm	2
17L	 2737mm	1
17R	 2737mm	1
14-1	 2672mm	1
G9	 1990mm	2
G5	 60mm	2

ŠT.	DEL	KOLIČINA
14	 2720mm	1
7	 1819mm	8
4	 1819mm	2
P7	 1252mm	4
P8	 1232mm	4
P1	 1819mm	12
P2	 1819mm	2
P5	 1350mm	2
P6	 1350mm	2
P10	 1350mm	4
P9	 1350mm	16
C1	 2478mm	8
C9	 194mm	4
C10	 210mm	8
GC	 120mm	4
G11		2
M1		2
M3		2
C21		4

SL







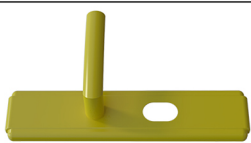

SEZNAM DELOV

ŠT.	DEL	KOLIČINA
D1	 1770mm	1
D2	 1770mm	1
SX		1
YS		1
SX1	 75mm	1

ŠT.	DEL	KOLIČINA
F1	 ST4.2*10	500
F2	 M4*10	60
F3	 M5*12	26
F5		34
F6		22
S2		120
S3		120
S4		190
F4		10
C20		4
G1		4
B6		4
QD8		4
M8		4
G3		2
FS		2
FS1		4

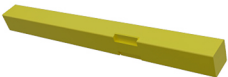
SL

SEZNAM DELOV

ŠT.	DEL	KOLIČINA
BW		1
BN		1
BD		2
HZ1		1
HZ2		1
FG		1
FG1		2
FG2		2
FG3		2

PREGLED ZA MONTAŽO

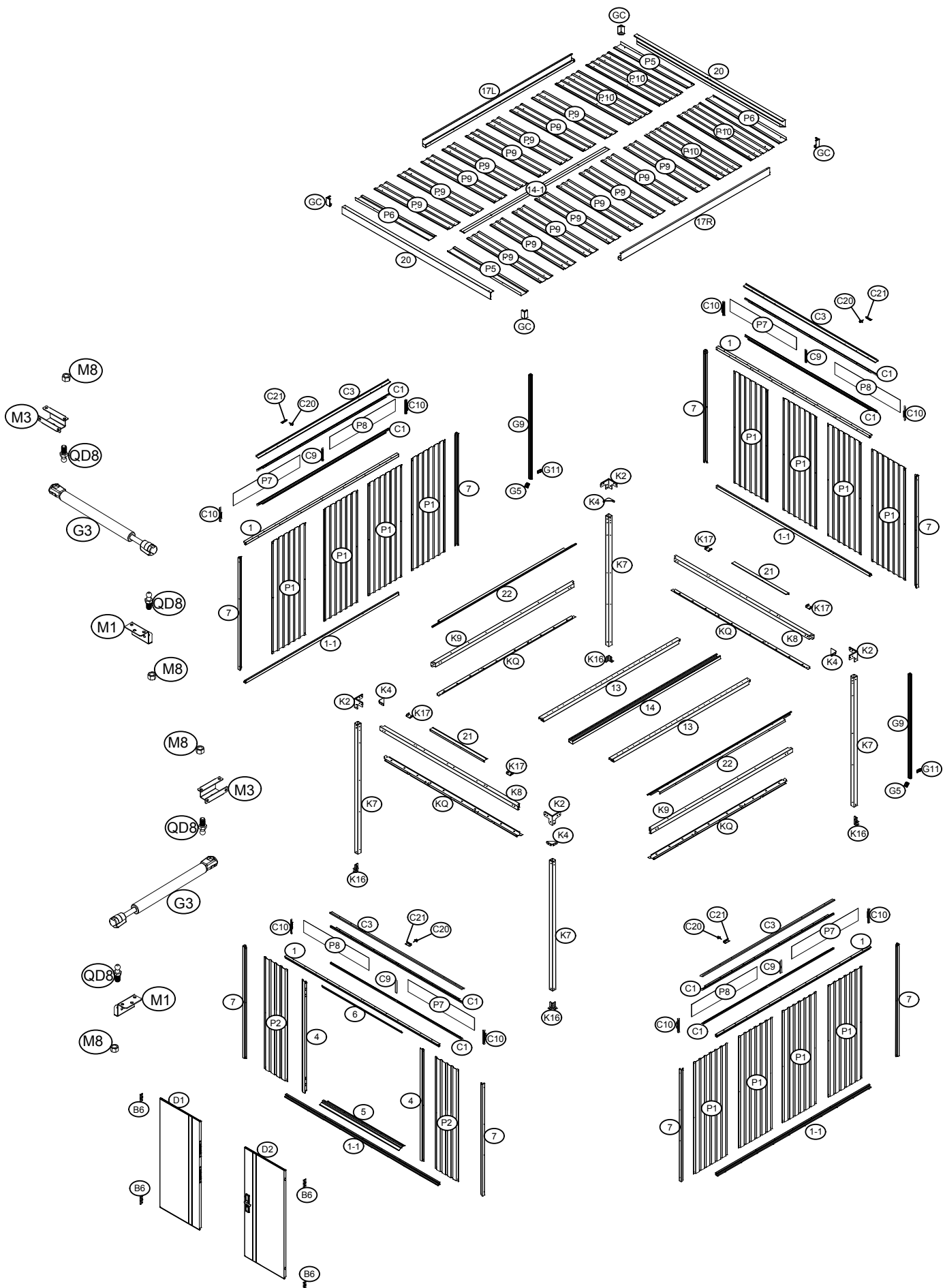

SL

PRAKTIČNI DODATKI – NA VOLJO PO IZBIRI

Talni okvir
izdelek št. 018011

**2. Montaža in
namestitev hiše
na talni okvir.**



SL

**1. Montaža in
namestitev talnega
okvirja.**

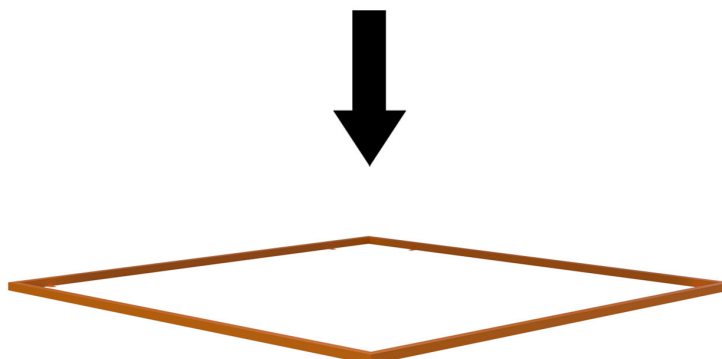

Aluminijast talne plošče
izdelek št. 018012

Kot podnožje priporočamo XPS plošče debeline 4 cm.
(niso vključene v obseg dobave)

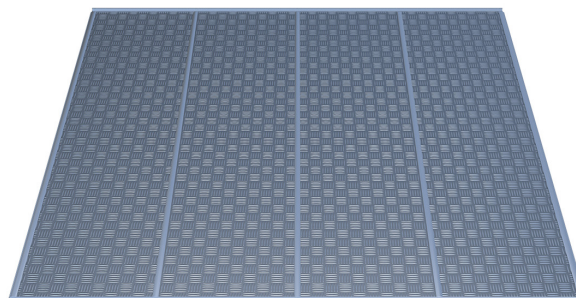

PRÉMIOVÁ KVALITA SYSTÉMOVÝ DŮM SE SVĚTLÍKEM 7,5 FIRSTLINE NÁVOD PRO MONTÁŽ

Rozměry: D x Š x V 274 x 274 x 218 cm



CZ

POUŽITÍ V SOULADU S URČENÍM:

Domek na nářadí je určen pro venkovní použití a slouží k uskladnění zahradního nářadí, vybavení a jiných potřeb. Není vhodný pro ubytování osob nebo zvířat ani pro skladování nebezpečných látek. Domek na nářadí není vhodný pro komerční využití. Jakékoli jiné použití nebo úpravy domku na nářadí se považuje za použití v rozporu s určením a může způsobit značné nebezpečí.

UPOZORNĚNÍ:

Před zahájením montáže přístřešku si pečlivě přečtěte montážní pokyny.

To se týká především bezpečnostních pokynů.

V opačném případě byste se mohli zranit nebo poškodit přístřešek.

Přístřešek není lezeckým rámem pro děti a není lezeckou pomůckou. Hrozí nebezpečí přetížení.

Ujistěte se, že všechny požadované komponenty jsou k dispozici v určeném množství.

Jednotlivé montážní kroky provádějte jeden po druhém a v pořadí uvedeném v tomto návodu.

Nevynechte žádný z uvedených kroků ani je nezkracujte.

Návod pro montáž uschovejte na bezpečném místě, abyste jej v budoucnu mohli využít.

Naplánujte si instalaci! Pokud použijete podlahový rám, musíte jej namontovat jako první.

VŠEOBECNÉ INFORMACE:

Před zahájením montáže se ujistěte, že jsou dodržovány pro vás platné směrnice/zákony. Pro montáž si naplánujte minimálně 300 až 360 minut.

Pro montáž je zapotřebí minimálně 4 osob. Před zahájením práce zkontrolujte, zda jsou všechny díly k dispozici ve správném množství. K montáži zvolte volnou, slunnou plochu bez přečnávajících větví.

Před zahájením montáže zkontrolujte, zda jsou jednotlivé konstrukční díly neporušené, a položte je tak, aby byly během práce snadno dostupné.

Nejllepší je uchovávat malé části, jako jsou šrouby, matice atd., v misce tak, aby nedošlo k jejich ztrátě.

Přístřešek v žádném případě nepoužívejte jako pomůcku pro popínání luštěnin, popínavých rostlin, ovoce, zeleniny nebo jako držák na prádelní šňůru.

Z přístřešku odstraňujte sníh a spadané listí. **Max. nosnost 150 kg/m².**

Přístřešek používejte pouze tak, jak je to popsáno v tomto montážním návodu.

A gyártó vagy a kereskedő nem vállal felelősséget olyan károktól, amelyek a rendeltetésellenes vagy hibás használat miatt következnek be. Ne állítsa a kerti fészert közvetlenül a tűre vagy egyenetlen talajra, gondoskodjon a megfelelő teherbíró képességgel rendelkező vízszintes és stabil aljzatról. Javasoljuk, hogy rögzítse a kerti fészert szilárdan a talajhoz. Győződjön meg arról, hogy minden csavart szilárdan meghúzott és helyes irányban és vízszintesen áll a keret. Ellenőrizze rendszeresen, hogy szilárdan meghúzott minden csavart és szükség esetén húzza után azokat.

Některé kovové díly jsou opatřeny ochrannou fólií. Tuto fólii je nutno před zahájením montáže opatrně odstranit.

BEZPEČNOSTNÍ POKYNY:

Nikdy nestoupejte přímo na plochu střechy, hrozí nebezpečí přetížení. To platí i během montáže a čištění.

Hrozí nebezpečí pro děti a osoby s omezenými fyzickými, smyslovými nebo mentálními schopnostmi (např. unavení lidé, částečně zdravotně postižení lidé, starší lidé se sníženou fyzickou a duševní schopností) nebo nedostatkem zkušeností a znalostí (např. starší děti). Při montáži přístřešku se používají malé části, jako jsou šrouby a matice, které při spolknutí představují nebezpečí udušení.

Zahradní přístřešek mohou postavit pouze kvalifikované osoby, nikoli děti nebo osoby s omezenými intelektuálními nebo motorickými dovednostmi nebo nedostatkem zkušeností.

Nesprávné zacházení s přístřeškem může způsobit zranění nebo materiální škody.

Při vybalování jednotlivých konstrukčních dílů z obalu buďte opatrní. **Hrozí nebezpečí poranění o ostré hrany.**

Jednotlivé komponenty jsou vyrobeny z kovu a jsou proto těžké. Pokud je obal otevřen neopatrně, například ostrým nožem nebo jiným ostrým/špičatým předmětem, může dojít k poškození jednotlivých součástí. Po vybalení součástí zkontrolujte, zda jsou všechny jednotlivé díly k dispozici ve správném množství. Jednotlivé díly položte na deku a podobně, abyste zabránili poškrábání horních vrstev.

Zkontrolujte, zda jsou jednotlivé konstrukční díly v perfektním stavu nebo zda nevykazují známky poškození, v takovém případě poškozené a deformované součásti nepoužívejte.

Během výstavby a montáže vždy noste ochranný oděv. K základnímu vybavení patří bezpečnostní obuv, ochranné rukavice, ochranné brýle a helma.

Výstavbu přístřešku neprovádějte ve velmi větrných nebo deštivých dnech.

Ujistěte se, že se komponenty nedotýkají žádných napájecích kabelů.

Obaly, plastové sáčky nebo ochranné fólie řádně zlikvidujte a uchovávejte je mimo dosah dětí, nebezpečí udušení!

Přístřešek postavte na rovnou plochu.

Během montáže se ujistěte, že se v nebezpečné oblasti nenacházejí žádné děti.

Přístřešek neumísťujte na místa vystavená silnému nebo trvalému větru.

Pro vaši osobní bezpečnost byste přístřešek neměli stavět, pokud jste unavení, opilí nebo intoxikovaní, nebo máte-li závratě nebo není-li vám dobře.

Používáte-li žebříky nebo elektronická zařízení, ujistěte se, že dodržíte pokyny výrobce k jejich používání. Horká zařízení, jako jsou grily, ohříváče, hořáky atd., nesmíte pod přístřeškem používat ani skladovat, nebezpečí požáru!

Během bouřky se nikdy nezdržujte v přístřešku nebo v jeho blízkosti. Hrozí nebezpečí úderu blesku.

PÉČE A ÚDRŽBA:

Povrch pravidelně čistěte. Pokud si všimnete škrábanců na povrchu, okamžitě je odstraňte pomocí vhodného laku.

Nepoužívejte agresivní čisticí prostředky, kovové nebo nylonové kartáče ani ostré nebo kovové pomůcky, jako jsou nože nebo špachtle. K čištění používejte měkké štětiny. Použijte studenou, čistou vodu.

NÁŘADÍ A VYBAVENÍ:

Ochranné oděvy (bezpečnostní obuv, ochranné rukavice, ochranné brýle, helma atd.)

Vodováha

Měření délky

Štafle (přibližně 1,5 m vysoké)

Šroubový nebo řehtačkový klíč

Akumulátorový šroubovák a vrtačka s růz. nástavci

Šroubovák

Těsnicí materiál

(Není součástí dodávky)

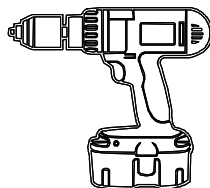
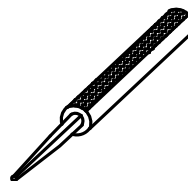
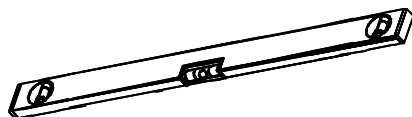
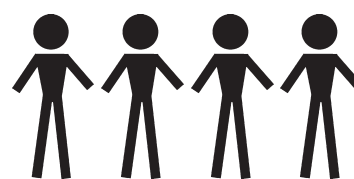

CZ

LIKVIDACE OBALU:

Obaly zlikvidujte do tříděného dopadu.

Karton a lepenka se likvidují jako odpadní papír a fólie odevzdejte k vhodné recyklaci.

LIKVIDACE PŘÍSTŘEŠKU:

Při likvidaci zahradního přístřešku věnujte pozornost pokynům, zákonům a předpisům týkajícím se likvidace ve vaší zemi nebo státě.

ROZMĚRY

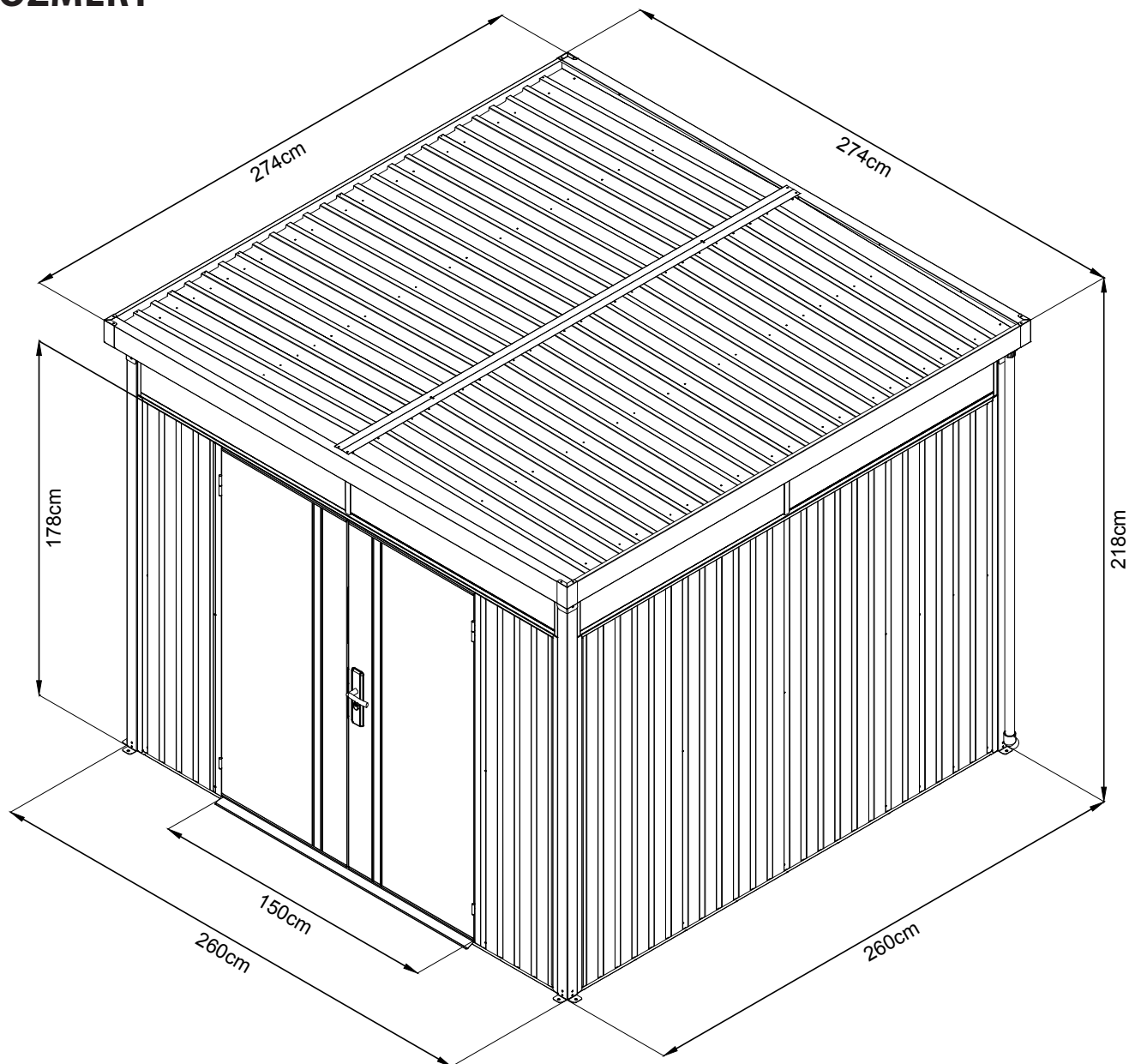

CZ

VYSVĚTLENÍ SYMBOLŮ



Montáž s/ bez
podlahovým rámem ?



Montáž s podlahovým rámem



Montáž bez podlahového rámu



Nechat krytku podložky
otevřenou / otevřít krytku





























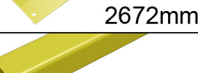





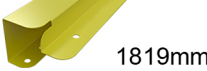

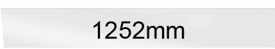
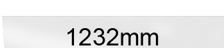

Zavřít krytku podložky

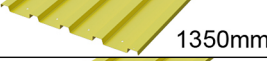

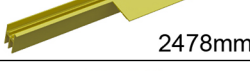
na řeznou hranu aplikujte
ochranu proti korozi





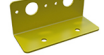











SEZNAM DÍLŮ

č.	SOUČÁST	MNOŽSTVÍ
K2		4
K9	 2604mm	2
K4		4
K8	 2444mm	2
K7	 2059mm	4
13	 2542mm	2
K16		4
K17		4
KQ	 2520mm	4
C3	 2495mm	4
1	 2481mm	4
1-1	 2481mm	4
22	 2649mm	2
21	 1000mm	2
5	 1490mm	1
6	 1490mm	1
20	 2736mm	2
17L	 2737mm	1
17R	 2737mm	1
14-1	 2672mm	1
G9	 1990mm	2
G5	 60mm	2









č.	SOUČÁST	MNOŽSTVÍ
14	 2720mm	1
7	 1819mm	8
4	 1819mm	2
P7	 1252mm	4
P8	 1232mm	4
P1	 1819mm	12
P2	 1819mm	2
P5	 1350mm	2
P6	 1350mm	2
P10	 1350mm	4
P9	 1350mm	16
C1	 2478mm	8
C9	 194mm	4
C10	 210mm	8
GC	 120mm	4
G11		2
M1		2
M3		2
C21		4

SEZNAM DÍLŮ

Č.	SOUČÁST	MNOŽSTVÍ
D1	 1770mm	1
D2	 1770mm	1
SX		1
YS		1
SX1	 75mm	1

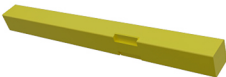
Č.	SOUČÁST	MNOŽSTVÍ
F1	 ST4.2*10	500
F2	 M4*10	60
F3	 M5*12	26
F5		34
F6		22
S2		120
S3		120
S4		190
F4		10
C20		4
G1		4
B6		4
QD8		4
M8		4
G3		2
FS		2
FS1		4

SEZNAM DÍLŮ

č.	SOUČÁST	MNOŽSTVÍ
BW		1
BN		1
BD		2
HZ1		1
HZ2		1
FG		1
FG1		2
FG2		2
FG3		2

MONTÁŽNÍ PŘEHLED

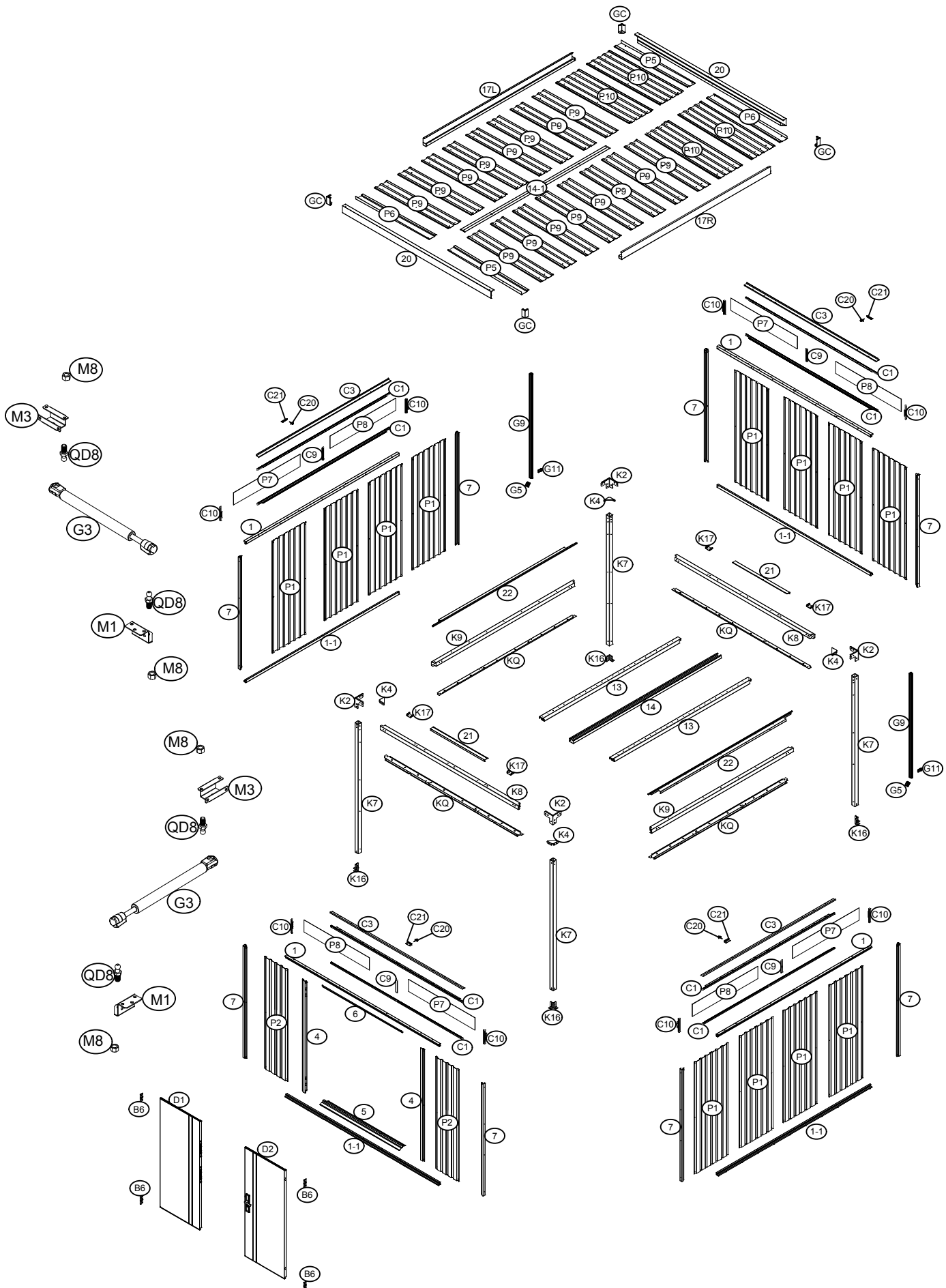

CZ

PRAKTICKÉ PŘÍSLUŠENSTVÍ – K DISPOZICI VOLITELNĚ

Podlahový rám
Č. 018011

2. Montáž a umístění domku na podlahový rám.



1. Montáž a umístění podlahového rámu.

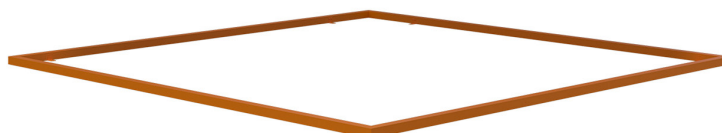

CZ

Hliníkové podlahové desky
Č. 018012

Jako podklad doporučujeme desky XPS o tloušťce 4 cm. (nejsou součástí dodávky)

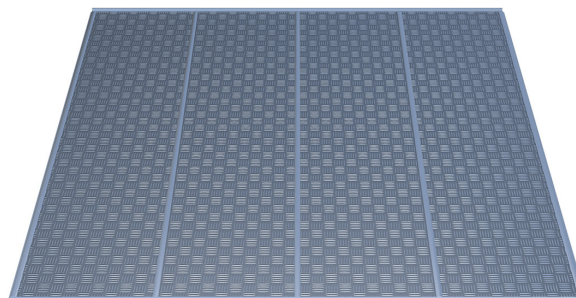

PREMIUM ZÁHRADNÝ DOMČEK SO SVETLÍKOM Q7,5 FIRSTLINE NÁVOD NA MONTÁŽ

Rozmery: D x Š x V 274 x 274 x 218 cm



SK

ÚČEL POUŽITIA:

Záhradný domček určený na použitie vonku a slúži na uchovávanie záhradného náradia, prístrojov a pomôcok. Nie je vhodný na ubytovanie osôb alebo zvierat ani na skladovanie nebezpečných látok. Záhradný domček nie je vhodný na komerčné použitie. Akékoľvek iné použitie alebo zmeny na záhradnom domčeku sa považuje za použitie v rozpore s účelom a môže spôsobiť vážne nebezpečenstvá.

UPOZORNENIE:

Pred začatím montáže si pozorne prečítajte návod na montáž.

Dbajte o bezpečnosť a venujte pozornosť najmä bezpečnostným pokynom.

V opačnom prípade by ste sa mohli poraniť alebo poškodiť záhradný domček.

Záhradný domček nie je preliezka pre deti ani pomôcka na lezenie. Pozor na riziko preťaženia.

Uistite sa, že všetky požadované diely máte k dispozícii v špecifikovanom množstve.

Jednotlivé kroky montáže vykonávajte jeden po druhom a v špecifikovanom poradí, ako je uvedené v tomto návode.

Nevynechávajte ani neskracujte žiadny z uvedených krokov.

Návod na montáž uschovajte na bezpečnom mieste, aby ste k nemu mali prístup aj neskôr.

Montáž si naplánujte! Ak sa používa podlahový rám, musí sa namontovať ako prvý.

VŠEOBECNÉ INFORMÁCIE:

Pred začatím montáže sa uistite, že sú dodržané príslušné smernice/zákony. Na montáž si vyhradte najmenej 300 až 360 minút.

K montáži sú potrebné najmenej 4 osoby. Pred začatím práce skontrolujte, či máte všetky diely v správnom množstve. Na postavenie záhradného domčeka použite slnečnú plochu bez vyčnievajúcich vetiev.

Pred začatím montáže skontrolujte, či sú jednotlivé diely nedotknuté a položte ich tak, aby boli počas práce ľahko prístupné.

Najlepšie je uchovávať malé časti, ako sú skrutky, matice atď. v miske, aby sa nestratili.

Za žiadnych okolností nepoužívajte domček ako opornú konštrukciu na pestovanie strukovín a popínavých rastlín, ovocia, zeleniny alebo ako držiak na šnúru na bielizeň.

Udržujte záhradný domček bez snehu a lístia. **Maximálne zaťaženie 150 kg/m².**

Záhradný domček používajte výhradne na účely, ktoré sú uvedené v tomto návode na montáž.

Výrobca alebo predajca nenesie žiadnu zodpovednosť za škody spôsobené nevhodným alebo nesprávnym použitím.

Nestavajte záhradný domček priamo na trávniku alebo nerovnom povrchu, na jeho lokáciu vyhradte a zabezpečte vhodný, odolný, vodorovný a stabilný povrch. Odporúčame upevniť záhradný domček pevne k podlahe. Skontrolujte,

či sú všetky skrutky dotiahnuté a či je rám správne vyrovnaný a vo vodorovnej polohe. Pravidelne kontrolujte

dotiahnutie všetkých skrutiek a v prípade potreby ich dotiahnite. **Niektoré kovové časti sú pokryté ochrannou fóliou.**

Táto fólia musí byť pred zahájením montáže opatrne odstránená.

BEZPEČNOSTNÉ POKYNY:

Nikdy sa nestavajte priamo na plochu strechy, hrozí nebezpečenstvo preťaženia. Ani počas montáže alebo pri čistení.

Záhradný domček predstavuje riziko pre deti a ľudí s obmedzenými fyzickými, zmyslovými alebo mentálnymi schopnosťami (napr. unavení ľudia, čiastočne postihnutí ľudia, starší ľudia so zníženými fyzickými a duševnými schopnosťami) alebo nedostatkom skúseností a znalostí (napr. staršie deti). Pri montáži záhradného domčeka sa používajú malé časti, ako sú skrutky a matice, ktoré pri prehltnutí predstavujú riziko udusenía.

Montáž záhradného domčeka môžu vykonávať len kompetentné osoby, nie deti alebo osoby s obmedzenými intelektuálnymi alebo motorickými zručnosťami alebo nedostatkom skúseností.

Nesprávna manipulácia so záhradným domčekom môže viesť k zraneniam alebo materiálным škodám.

Venujte zvýšenú opatrnosť vybalovaniu jednotlivých dielov z obalu. **Ostré hrany predstavujú riziko poranenia.**

Jednotlivé diely sú vyrobené z kovu a sú preto ťažké. Pri neopatrnom otváraní obalu, napríklad ostrým nožom alebo iným ostrým/špicatým predmetom, môže dôjsť k poškodeniu dielov. Po rozbalení dielov skontrolujte, či sú všetky jednotlivé diely dodané v správnom množstve. Jednotlivé diely položte na prikrývku alebo niečo podobné, aby ste zabránili poškriabaniu laku.

Skontrolujte, či sú jednotlivé diely v bezchybnom stave, či nevykazujú známky poškodenia, v takom prípade nepoužívajte poškodené a zdeformované časti.

Počas stavby a montáže vždy noste ochranný odev. Medzi jeho základné vybavenie patrí bezpečnostná obuv, ochranné rukavice, bezpečnostné okuliare a prilba.

Nestavajte záhradný domček vo veľmi veternom alebo daždivom počasí.

Skontrolujte, či sa diely nedotýkajú žiadnych napájacích káblov.

Obal, plastové vrecúška alebo ochrannú fóliu zlikvidujte správnym spôsobom a uchovávajte mimo dosahu detí, nebezpečenstvo udusenía!

Záhradný domček položte na rovný povrch.

Počas montáže skontrolujte, či sa v nebezpečnej zóne nenachádzajú žiadne deti.

Neumiestňujte záhradný domček na miesta vystavené silnému alebo trvalému vetru.

Kvôli vašej osobnej bezpečnosti by ste nemali stavať záhradný domček, keď ste unavení, opití alebo intoxikovaní, alebo ak máte závraty alebo nepríjemné pocity.

Ak používate rebríky alebo elektronické zariadenia, uistite sa, že dodržiavate pokyny na použitie, odporúčané ich výrobcami. Horúce zariadenia, ako sú grily, ohrievače, horáky atď. sa v záhradnom domčeku nesmú používať ani skladovať, nebezpečenstvo požiaru! Počas búrok alebo blýskania nikdy nezostávajú v záhradnom domčeku ani vedľa neho. Hrozí riziko zásahu bleskom.

STAROSTLIVOSŤ A ÚDRŽBA:

Pravidelne čistite povrch. Ak si všimnete škrabance na povrchu, okamžite ich odstráňte vhodným lakom.

Nepoužívajte agresívne čistiace prostriedky, kefy s kovovými alebo nylonovými štetinami ani ostré alebo kovové nástroje, ako sú nože alebo špachtle. Na čistenie používajte kefy s mäkkými štetinami. Používajte studenú, čistú vodu.

NÁRADIE A VYBAVENIE:

Ochranné odevy (bezpečnostná obuv, ochranné rukavice, bezpečnostné okuliare, prilba atď.)

Vodováha

Meracie pásmo

Rebrík (vysoký približne 1,5 m)

Kľúč alebo račňový kľúč

Akumulátorové skrutky a vrtáčky s príslušenstvom

Skrutkovač

Tesniaci materiál

(nie je súčasťou dodávky)

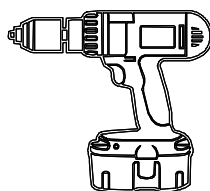
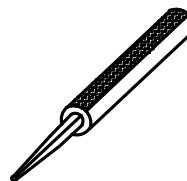
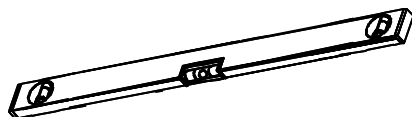
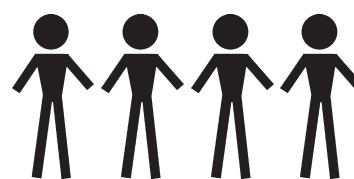

SK

LIKVIDÁCIA OBALU:

Balenie zlikvidujte podľa jeho typu.

Kartón a lepenku likvidujte ako odpadový papier a fólie odneste do príslušného recyklačného strediska.

LIKVIDÁCIA ZÁHRADNÉHO DOMČEKA:

Pri likvidácii záhradného domčeka dbajte o pokyny, zákony a nariadenia týkajúce sa likvidácie vo vašej krajine alebo štáte.

ROZMERY

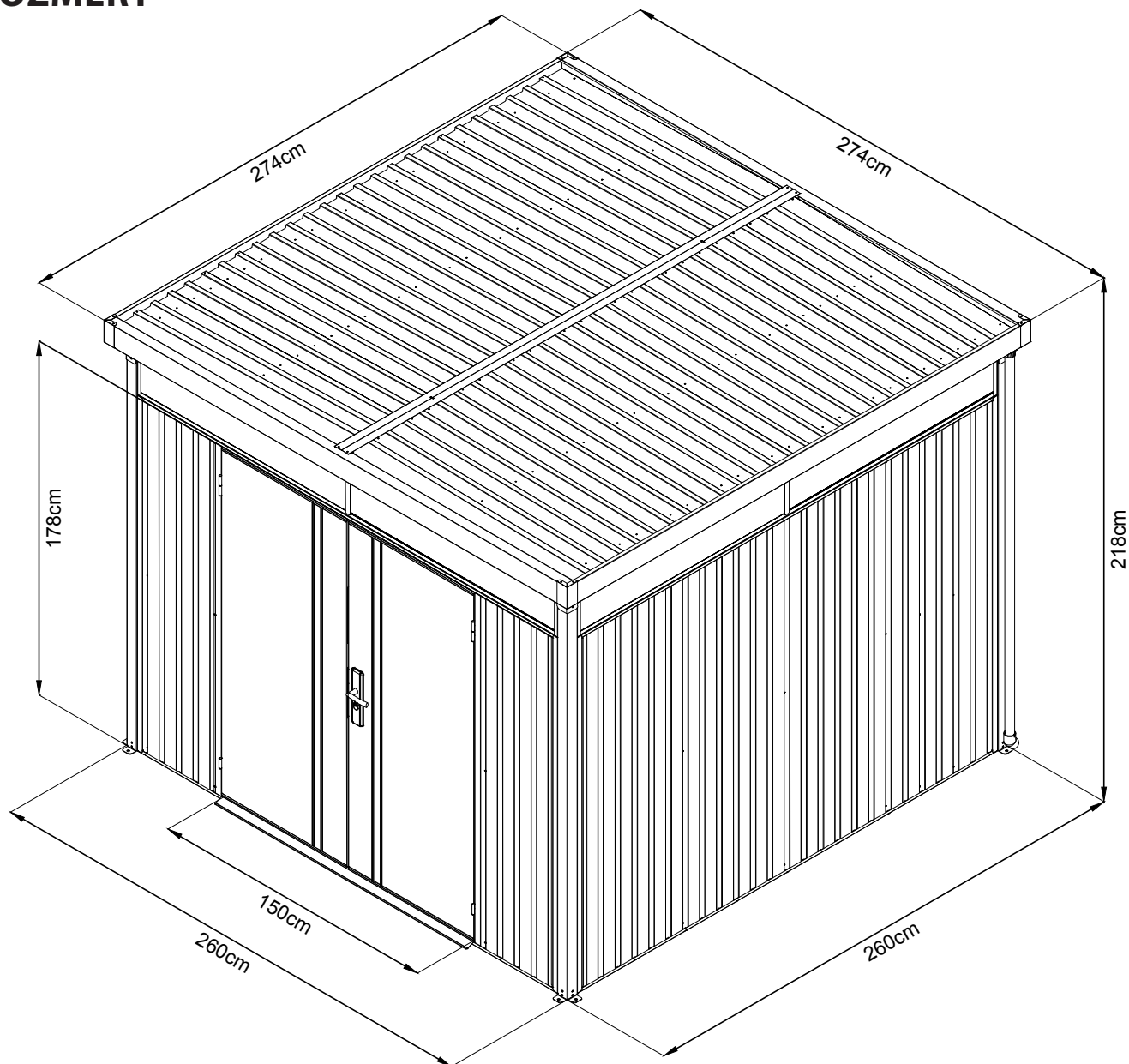

SK

VYSVETLENIE SYMBOLOV



Montáž s/ bez
podlahovým rámom?



Montáž s podlahovým rámom



Montáž bez podlahového rámu

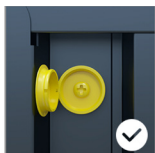

Uzáver podložky nechajte
otvorený/otvorte











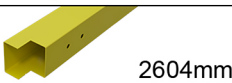









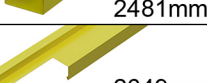
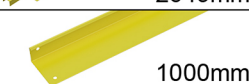



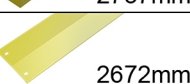









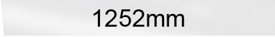
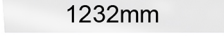

Zatvorte uzáver podložky

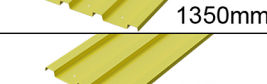
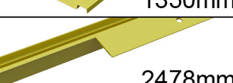

Na reznú hranu namontujte
ochranu proti hrdzi

















ZOZNAM ČASTÍ

ČÍSLO	ČASTÍ	MNOŽSTVO
K2		4
K9	 2604mm	2
K4		4
K8	 2444mm	2
K7	 2059mm	4
13	 2542mm	2
K16		4
K17		4
KQ	 2520mm	4
C3	 2495mm	4
1	 2481mm	4
1-1	 2481mm	4
22	 2649mm	2
21	 1000mm	2
5	 1490mm	1
6	 1490mm	1
20	 2736mm	2
17L	 2737mm	1
17R	 2737mm	1
14-1	 2672mm	1
G9	 1990mm	2
G5	 60mm	2

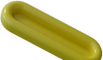

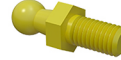





ČÍSLO	ČASTÍ	MNOŽSTVO
14	 2720mm	1
7	 1819mm	8
4	 1819mm	2
P7	 1252mm	4
P8	 1232mm	4
P1	 1819mm	12
P2	 1819mm	2
P5	 1350mm	2
P6	 1350mm	2
P10	 1350mm	4
P9	 1350mm	16
C1	 2478mm	8
C9	 194mm	4
C10	 210mm	8
GC	 120mm	4
G11		2
M1		2
M3		2
C21		4

ZOZNAM ČASTÍ

ČÍSLO	ČASTÍ	MNOŽSTVO
D1	 1770mm	1
D2	 1770mm	1
SX		1
YS		1
SX1	 75mm	1

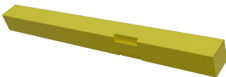
ČÍSLO	ČASTÍ	MNOŽSTVO
F1	 ST4.2*10	500
F2	 M4*10	60
F3	 M5*12	26
F5		34
F6		22
S2		120
S3		120
S4		190
F4		10
C20		4
G1		4
B6		4
QD8		4
M8		4
G3		2
FS		2
FS1		4

ZOZNAM ČASTÍ

ČÍSLO	ČASTÍ	MNOŽSTVO
BW		1
BN		1
BD		2
HZ1		1
HZ2		1
FG		1
FG1		2
FG2		2
FG3		2

PREHĽAD MONTÁŽE

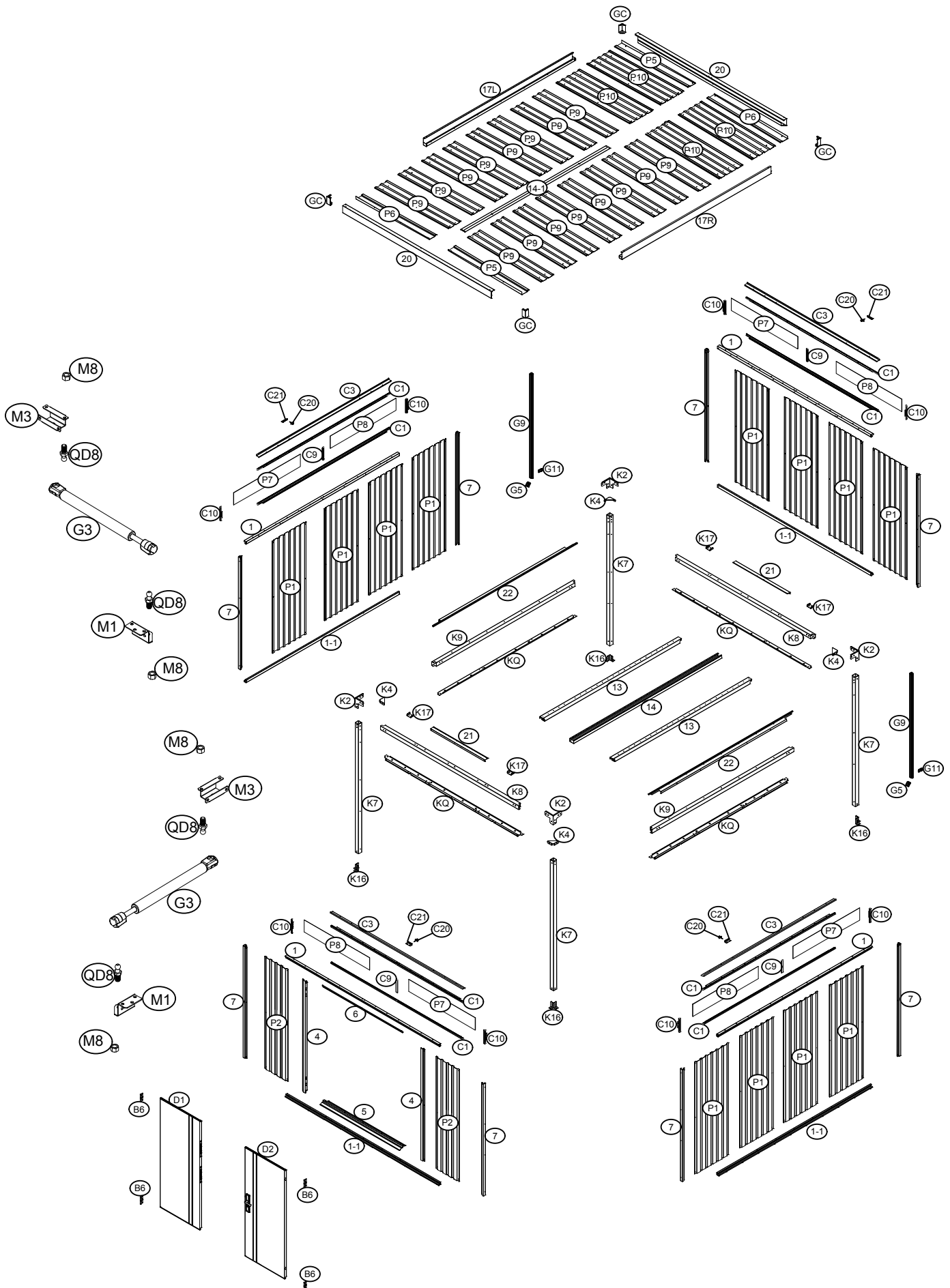

SK

PRAKTICKÉ PRÍSLUŠENSTVO – VOLITEĽNE DOSTUPNÉ

Podlahový rám
číslo 018011

**2. Montáž a
umiestnenie prístrešku
na podlahový rám.**



SK

**1. Montáž a
umiestnenie
podlahového rámu.**

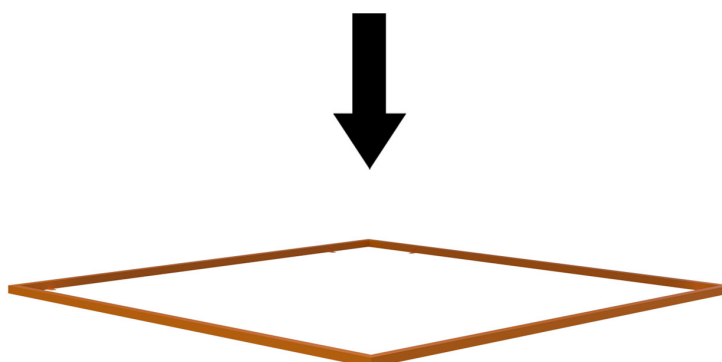

Hliníkový podlahové dosky
číslo 018012

Pod konštrukciu odporúčame dosky XPS
s hrúbkou 4 cm. (nie sú súčasťou dodania)

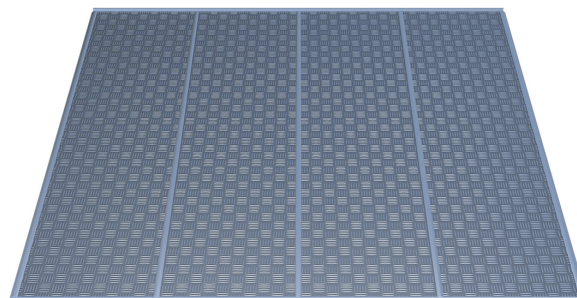

SYSTEMHUS PREMIUM Q7,5 FIRSTLINE MONTERINGSANVISNING

Mått: L x B x H 274 x 274 x 218 cm



SE

AVSEDD ANVÄNDNING

Redskapsboden är avsedd för utomhusbruk och ska användas för att förvara trädgårdsredskap, apparater och verktyg. Den är inte lämplig för att låta människor eller djur bo där eller för att förvara farliga substanser. Verktygsboden är inte lämplig för kommersiellt bruk. All annan användning eller modifiering av redskapsboden anses vara felaktig användning och kan orsaka stor fara.

INFORMATION

Läs igenom monteringsanvisningen noga innan du börjar montera förrådet.

Detta gäller i synnerhet säkerhetsanvisningarna.

Annars kan det leda till personskador eller skador på förrådet.

Förrådet är ingen klätterställning för barn och ingen spaljé – risk för överbelastning!

Säkerställ att alla nödvändiga delar finns i angiven mängd.

Sätt ihop delarna i angiven ordningsföljd enligt instruktionerna i den medföljande monteringsanvisningen noga.

Hoppa inte över eller förenkla angivna steg.

Förvara monteringsanvisningen på en säker plats för senare användning.

Planera din installation! Om du använder en golvram måste den installeras först.

ALLMÄN INFORMATION

Innan du påbörjar monteringen ska du säkerställa att du följer gällande riktlinjer/bestämmelser.

Räkna med minst 300–360 minuter för monteringen.

Det krävs minst två personer för att montera produkten. Kontrollera innan arbetet påbörjas att alla delar finns i angiven mängd. Montera produkten på en öppen, solig plats utan överskjutande grenar.

Kontrollera att de enskilda delarna är oskadda och lägg dem så att du enkelt kan nå dem under monteringen.

Lägg gärna smådelar såsom skruvar, muttrar osv. i en skål så att de inte försvinner.

Förrådet ska under inga omständigheter användas som klättringshjälp för baljväxter, kläng- och slingerväxter, frukt, grönsaker eller som hållare för tvättlinan.

Håll förrådet fritt från snö och löv. **Max. bärformåga: 150 kg/m².**

Använd förrådet uteslutande så som beskrivet i monteringsanvisningen.

Tillverkaren eller återförsäljaren ansvarar inte för skador som kan uppstå på grund av olämplig eller felaktig användning.

Placera inte förrådet direkt på en gräsmatta eller ett ojämnt underlag; säkerställ ett lämpligt hållbart, vågrätt och stabilt underlag. Vi rekommenderar att du förankrar förrådet i underlaget.

Säkerställ att alla skruvar är åtdragna och att ramen är korrekt anpassad och vågrät. Kontrollera regelbundet att alla skruvar är åtdragna och dra åt eventuellt lösa skruvar vid behov.

Vissa metalldelar har försetts med en skyddsfolie. Avlägsna denna folie försiktigt innan du påbörjar monteringen.

SÄKERHETSANVISNINGAR

Stå aldrig direkt på takytan, det finns risk för överbelastning. Inte heller vid montering eller vid rengöring.

Det finns risk för skada på barn och personer med nedsatt känsel, fysisk eller psykisk kapacitet (t.ex. uttröttade personer, personer med funktionsnedsättning, äldre personer med nedsatt fysisk och psykisk kapacitet) eller bristande erfarenhet och kunskap (t.ex. äldre barn). Små delar såsom skruvar och muttrar för montering av förrådet medföljer och kan orsaka kvävning om de sväljs.

Förrådet ska enbart monteras av yrkeskunniga personer, inte av barn eller personer med nedsatt känsel eller motorik eller bristande erfarenhet.

Felaktig hantering/användning av förrådet kan leda till personskador eller materiella skador.

Var försiktig när du packar upp de enskilda delarna ur förpackningen.

Det finns en skaderisk på grund av vassa kanter.

Vissa delar består av metall och är därför tunga. Vid oförsiktigt öppnande av förpackningen, t.ex. med en vass sax eller ett annat vasst eller spetsigt föremål, riskerar du att skada delarna. Efter upppackning, kontrollera att alla delar finns i angiven mängd. Lägg de enskilda delarna på en filt eller liknande för att undvika repor i beläggningen.

Kontrollera att de olika delarna är i gott skick och oskadda – skadade eller deformerade delar ska inte användas.

Använd alltid personlig skyddsutrustning under monteringen. Till grundutrustningen hör skyddsskor, skyddshandskar, skyddsglasögon och hjälm.

Installera inte förrådet om det blåser eller regnar kraftigt.

Säkerställ att delarna inte nuddar någon strömkabel.

Kassera förpackning, plastpåse eller skyddsfolie på lämpligt sätt och förvara dessa utom räckhåll för barn – kvävningsrisk!

Placera förrådet på ett jämnt underlag.

Säkerställ att inga barn befinner sig i riskområdet under monteringen.

Placera inte förrådet i områden som utsätts för stark eller ihållande vind.

För din egen säkerhet ska du inte montera förrådet om du är trött, berusad eller påverkad, eller när du känner dig yr eller illamående.

Vid användning av stegar eller elektroniska apparater ska tillverkarens anvisningar alltid följas.

Varma apparater, som grillar, element, brännare osv., ska inte användas eller förvaras i närheten av förrådet – brandrisk!

Stå aldrig inuti eller under förrådet vid oväder eller åskväder – risk för blixtnedslag!

SKÖTSEL OCH UNDERHÅLL

Rengör ytan regelbundet. Upptäcker du repor i beläggningen ska du genast åtgärda dessa med lämpligt lack.

Använd inga aggressiva rengöringsmedel, metall- eller nylonborstar, vassa hjälpmedel eller hjälpmedel av metall såsom kniv eller spatel. Använd en mjuk borste och kallt, rent vatten för att rengöra ytan.

VERKTYG OCH UTRUSTNING

Skyddskläder (skyddsskor, skyddshandskar, skyddsglasögon, hjälm osv.)

Vattenpass

Längdmått

Stege (ca 1,5 m hög)

Skruv- eller blocknyckel

Skruvdragare och bormaskin med olika tillbehör

Skruvmejsel

Tätningmaterial

(medföljer ej)

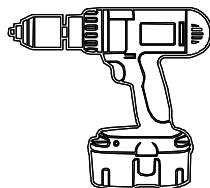
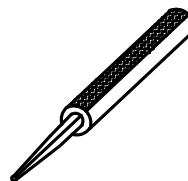
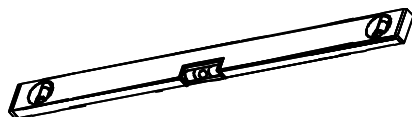
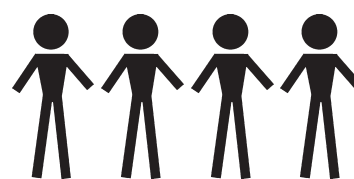

SE

AVFALLSHANTERING AV FÖRPACKNINGEN

Kassera förpackningen som sorterat avfall.

Papper och kartong ska sorteras som returpapper och folie som motsvarande återvinningsbart avfall.

AVFALLSHANTERING AV SYSTEMHUS

Ta hänsyn till gällande nationella riktlinjer, lagar och bestämmelser för avfallshantering.

MÅTT

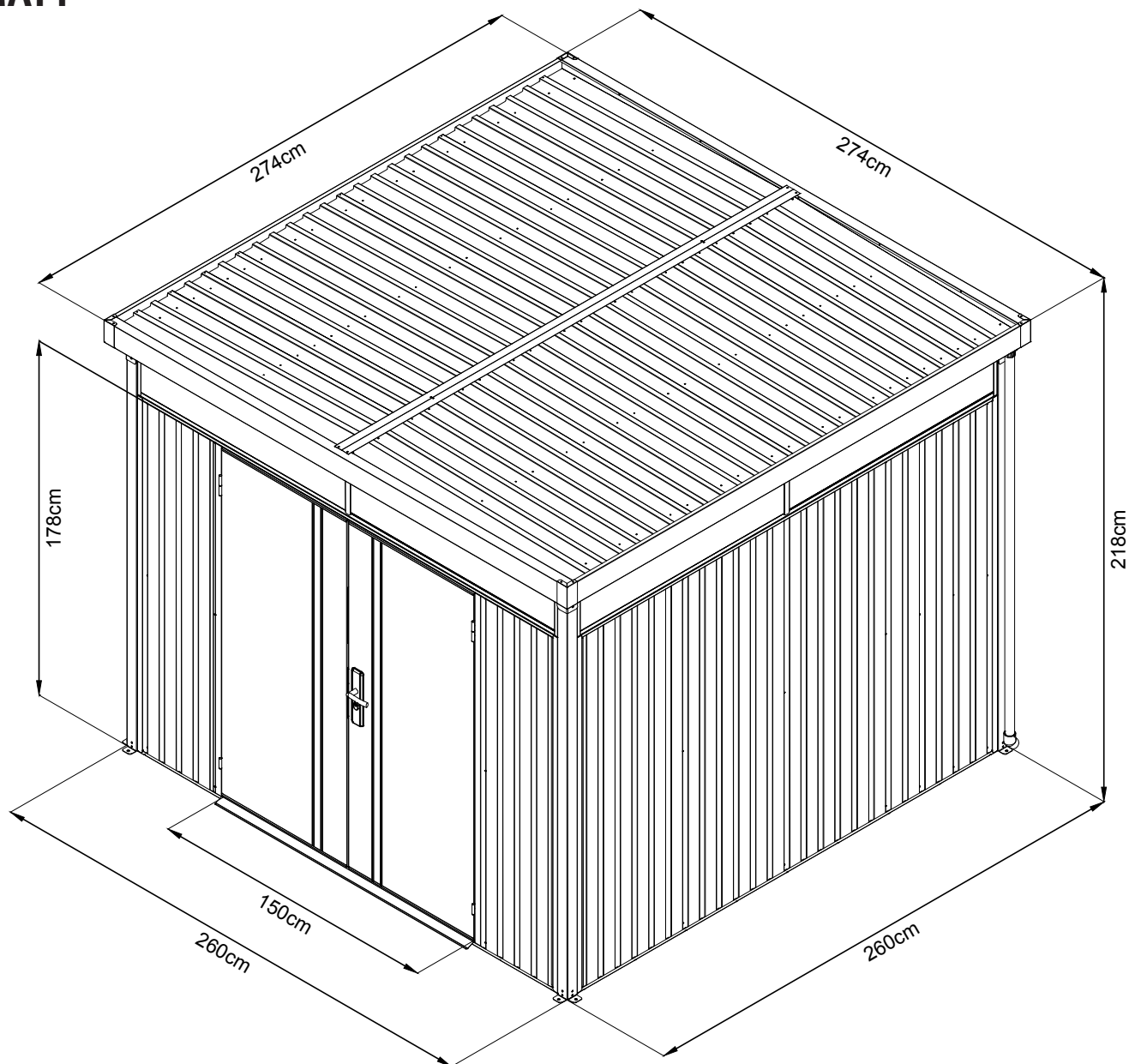

SE

SYMBOLFÖRKLARING



Montering med/ utan golvram ?

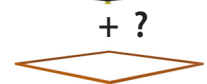

Lämna brickans lock öppet/öppna

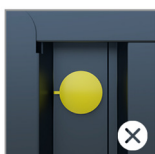

Stäng brickans lock



Montering med golvram





























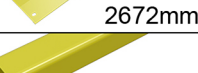







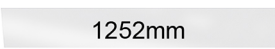
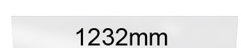



Montering utan golvram

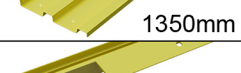
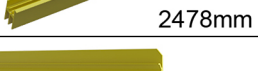

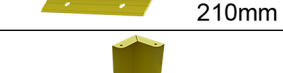
applicera rostskydd på fasade kanter















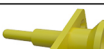

KOMPONENTLISTA

NR.	DEL	MÄNGD
K2		4
K9	 2604mm	2
K4		4
K8	 2444mm	2
K7	 2059mm	4
13	 2542mm	2
K16		4
K17		4
KQ	 2520mm	4
C3	 2495mm	4
1	 2481mm	4
1-1	 2481mm	4
22	 2649mm	2
21	 1000mm	2
5	 1490mm	1
6	 1490mm	1
20	 2736mm	2
17L	 2737mm	1
17R	 2737mm	1
14-1	 2672mm	1
G9	 1990mm	2
G5	 60mm	2





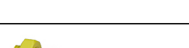

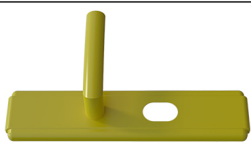

NR.	DEL	MÄNGD
14	 2720mm	1
7	 1819mm	8
4	 1819mm	2
P7	 1252mm	4
P8	 1232mm	4
P1	 1819mm	12
P2	 1819mm	2
P5	 1350mm	2
P6	 1350mm	2
P10	 1350mm	4
P9	 1350mm	16
C1	 2478mm	8
C9	 194mm	4
C10	 210mm	8
GC	 120mm	4
G11		2
M1		2
M3		2
C21		4

KOMPONENTLISTA

NR.	DEL	MÄNGD
D1	 1770mm	1
D2	 1770mm	1
SX		1
YS		1
SX1	 75mm	1

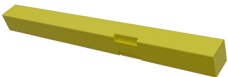
NR.	DEL	MÄNGD
F1	 ST4.2*10	500
F2	 M4*10	60
F3	 M5*12	26
F5		34
F6		22
S2		120
S3		120
S4		190
F4		10
C20		4
G1		4
B6		4
QD8		4
M8		4
G3		2
FS		2
FS1		4

KOMPONENTLISTA

NR.	DEL	MÄNGD
BW		1
BN		1
BD		2
HZ1		1
HZ2		1
FG		1
FG1		2
FG2		2
FG3		2

PRAKTISKA TILLBEHÖR – TILLGÄNGLIGA SOM TILLVAL

Bottenstomme
Art.nr. 018011

**2. Montering
och placering av
redskapsboden
på golvramen.**



SE

**1. Montering
och placering
av golvramen.**

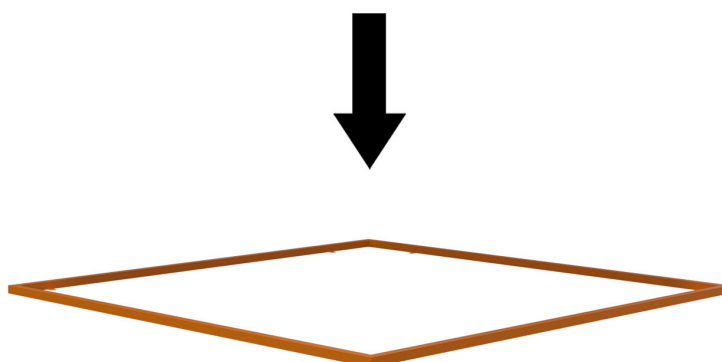

Aluminium Bottenskivor
Art.nr. 018012

Som underrede rekommenderar vi 4 cm tjocka XPS-sk
(ingår inte i leveransomfattningen)

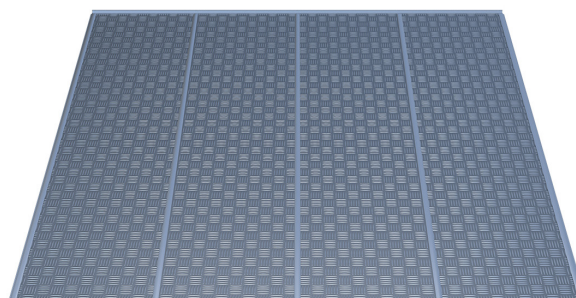

DOMEK SYSTEMOWY PREMIUM Q7,5 FIRSTLINE INSTRUKCJA MONTAŻU

Wymiary: 274 x 274 x 218 cm (dł. x szer. x wys.)



PL

UŻYTKOWANIE ZGODNE Z PRZEZNACZENIEM

Domek narzędziowy jest przeznaczony do użytku zewnętrznego i służy do przechowywania narzędzi ogrodowych, urządzeń i akcesoriów. Nie nadaje się na schronienie dla ludzi lub zwierząt ani do przechowywania substancji niebezpiecznych. Domek narzędziowy nie jest przeznaczony do użytku komercyjnego. Każde inne użycie lub modyfikacja domku narzędziowego jest uważane za niewłaściwe użytkowanie i może spowodować poważne zagrożenie.

WSKAZÓWKA

Przed rozpoczęciem montażu domku narzędziowego należy uważnie przeczytać instrukcję montażu. Dotyczy to w szczególności wskazówek bezpieczeństwa.

W przeciwnym razie może dojść do obrażeń ciała lub uszkodzenia domku narzędziowego.

Domek narzędziowy nie jest konstrukcją wspinaczkową dla dzieci ani elementem wspomagającym wspinanie. Istnieje ryzyko przeciążenia. Należy upewnić się, że wszystkie wymagane elementy są dostarczone w odpowiedniej ilości.

Poszczególne etapy montażu należy wykonywać jeden po drugim w kolejności określonej w niniejszej instrukcji. Nie należy pomijać ani skracać żadnego z określonych etapów.

Instrukcję montażu należy przechowywać w bezpiecznym miejscu, aby mieć do niej dostęp w późniejszym czasie.

Zaplanuj montaż! W przypadku stosowania ramy podłogowej należy ją najpierw zamontować.

INFORMACJE OGÓLNE

Przed rozpoczęciem montażu należy upewnić się, że spełnione są obowiązujące wytyczne/przepisy.

Na montaż należy zaplanować co najmniej 300–360 minut.

Montaż należy wykonywać co najmniej w dwie osoby. Przed rozpoczęciem pracy należy upewnić się, że wszystkie elementy są dostępne w odpowiedniej ilości. Montaż należy wykonywać na otwartej, nasłonecznionej przestrzeni bez wystających gałęzi. Przed rozpoczęciem montażu należy sprawdzić, czy poszczególne elementy są nienaruszone i rozmieścić je w taki sposób, aby były łatwo dostępne podczas pracy.

Małe części, takie jak śrubki, nakrętki itp. najlepiej przechowywać w miseczce, aby się nie zgubiły.

Nigdy nie używać domku narzędziowego jako pomocy do pięcia roślin strączkowych, pnączy i roślin pnących, owoców, warzyw lub jako podpory dla linki do prania.

Na domku narzędziowym nie mogą leżeć śnieg lub liście. **Maks. obciążenie 150 kg/m².**

Z domku narzędziowego należy korzystać wyłącznie w sposób opisany w niniejszej instrukcji montażu.

Producent i dystrybutor nie ponoszą odpowiedzialności za szkody wynikłe z niezgodnego z przeznaczeniem lub niewłaściwego użytkowania. Nie umieszczać domku narzędziowego bezpośrednio na trawie lub nierównej powierzchni, należy upewnić się, że podłoże jest odpowiednie, stabilne i równe.

Zalecamy trwałe zakotwiczenie domku narzędziowego w podłożu. Należy upewnić się, że wszystkie śruby są dokręcone, a rama jest prawidłowo ustawiona i wypoziomowana. Należy regularnie sprawdzać, czy wszystkie śruby są dokręcone i w razie potrzeby dokręcać je. **Niektóre elementy metalowe są pokryte folią ochronną.**

Przed rozpoczęciem montażu folię należy ostrożnie usunąć.

WSKAZÓWKI DOTYCZĄCE BEZPIECZEŃSTWA

Nigdy nie stawać bezpośrednio na powierzchni dachu, istnieje ryzyko przecięcia. Dotyczy to również montażu i czyszczenia.

Istnieje ryzyko dla dzieci i osób o ograniczonych zdolnościach fizycznych, sensorycznych lub umysłowych (np. osoby przemęczone, częściowo niepełnosprawne, osoby starsze o ograniczonych zdolnościach fizycznych i umysłowych) lub nieposiadających doświadczenia i wiedzy (np. starsze dzieci). Do montażu domku narzędziowego używane są małe części, takie jak śrubki i nakrętki, które stwarzają ryzyko zadławienia w przypadku połknięcia.

Domki narzędziowe mogą być montowane wyłącznie przez wykwalifikowane osoby, a nie przez dzieci lub osoby o ograniczonych zdolnościach umysłowych lub motorycznych bądź nieposiadające doświadczenia. Niewłaściwe obchodzenie się z domkiem narzędziowym może prowadzić do obrażeń ciała lub uszkodzenia mienia.

Podczas rozpakowywania poszczególnych komponentów z opakowania należy zachować ostrożność.

Istnieje ryzyko obrażeń spowodowanych ostrymi krawędziami. Poszczególne elementy są wykonane z metalu i dlatego są ciężkie. W przypadku nieostrożnego otwarcia opakowania, na przykład za pomocą ostrego noża lub innego ostrego przedmiotu, istnieje ryzyko uszkodzenia elementów.

Po rozpakowaniu elementów należy sprawdzić, czy wszystkie poszczególne części są dostępne w odpowiedniej ilości.

Umieścić poszczególne części na kocu lub podobnym materiale, aby uniknąć zarysowania powłoki.

Sprawdzić, czy poszczególne elementy są w nienagannym stanie, czy też są uszkodzone; jeśli tak jest, nie używać uszkodzonych, zdeformowanych części.

Podczas montażu i instalacji należy zawsze nosić odzież ochronną.

Podstawowe wyposażenie obejmuje obuwie ochronne, rękawice ochronne, okulary ochronne i kask.

Nie montować domku narzędziowego w bardzo wietrzne lub deszczowe dni.

Należy upewnić się, że elementy nie mają kontaktu z przewodami zasilającymi.

Opakowanie, plastikowe torebki lub folię ochronną należy utylizować w odpowiedni sposób i przechowywać w miejscu niedostępnym dla dzieci – ryzyko uduszenia!

Ustawić domek narzędziowy na równej powierzchni.

Należy upewnić się, że podczas montażu w strefie niebezpiecznej nie znajdują się dzieci.

Nie umieszczać domku narzędziowego w miejscach narażonych na silne lub długotrwałe oddziaływanie wiatru.

Dla własnego bezpieczeństwa nie należy ustawiać domku narzędziowego, będąc zmęczonym, pod wpływem alkoholu lub substancji odurzających, a także w przypadku zawrotów głowy lub złego samopoczucia.

W przypadku korzystania z drabin lub urządzeń elektronicznych należy postępować zgodnie z instrukcjami producenta.

W domku narzędziowym nie wolno używać ani przechowywać gorących sprzętów, takich jak grille, grzejniki, palniki itp. Podczas burzy lub w czasie wyładowań atmosferycznych nie wolno przebywać w domku narzędziowym ani w jego pobliżu. Istnieje ryzyko uderzenia pioruna.

KONSERWACJA I UTRZYMANIE

Regularnie czyścić powierzchnię. W przypadku zauważenia jakichkolwiek zadrapań na powierzchni, natychmiast usunąć je za pomocą odpowiedniego lakieru.

Nie używać agresywnych środków czyszczących, metalowych lub nylonowych szczotek ani ostrych lub metalowych narzędzi, takich jak noże lub szpachelki. Do czyszczenia należy stosować miękkie szczotki.

Używać zimnej, czystej wody.

NARZĘDZIA I WYPOSAŻENIE

Odzież ochronna (obuwie ochronne, rękawice ochronne, okulary ochronne, kask itp.)

Poziomica

Przyrząd pomiarowy

Drabina (wysokość ok. 1,5 m)

Klucz płaski lub grzechotka

Wkrętarka akumulatorowa i wiertarka z różnymi nasadkami

Śrubokręt

Materiał uszczelniający

(nie wchodzi w zakres dostawy)

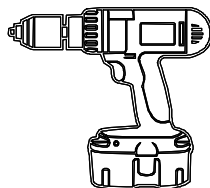
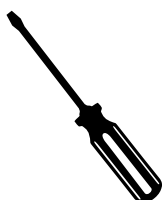
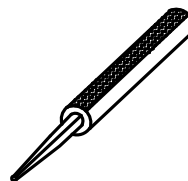
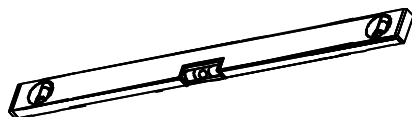
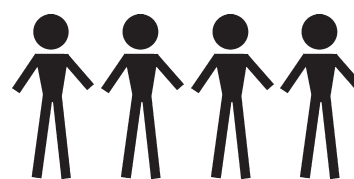

PL

UTYLIZACJA OPAKOWAŃ

Opakowanie należy zutylizować zgodnie z zasadami segregacji odpadów.

Karton i tektura podlegają utylizacji jako makulatura, a folie w ramach odpowiedniej zbiórki surowców wtórnych.

UTYLIZACJA DOMKU NARZĘDZIOWEGO

Podczas utylizacji domku narzędziowego należy przestrzegać obowiązujących wytycznych, przepisów i regulacji dotyczących utylizacji w danym kraju lub kraju związkowym.

WYMIARY

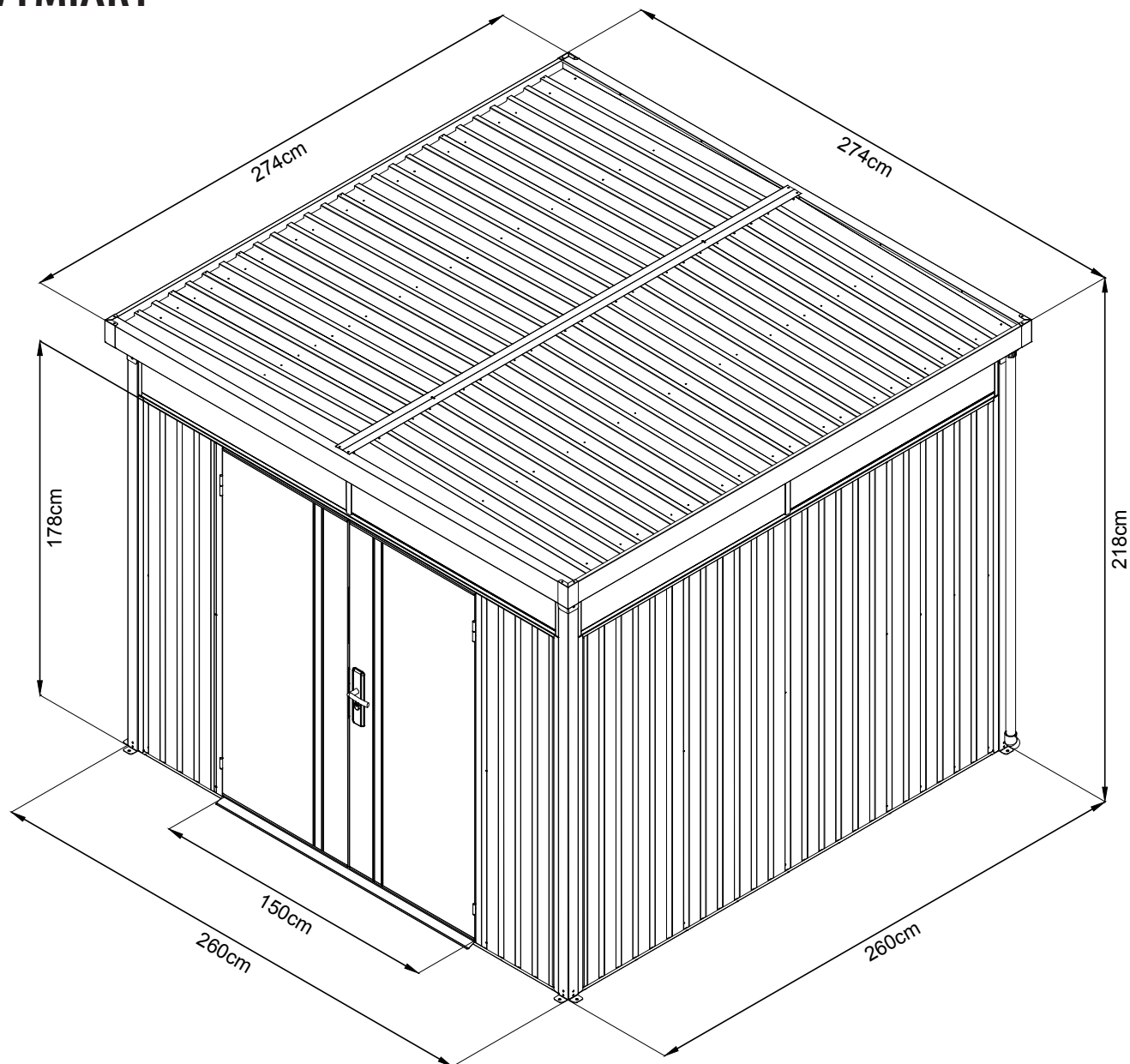

PL

OBJAŚNIENIE SYMBOLI



Montaż z / bez ramą
podłogową ?



Montaż z ramą podłogową

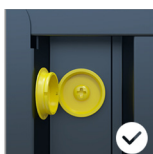

Pozostaw korek uszczelki
otwarty



Montaż bez ramy podłogowej





























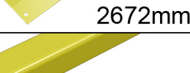





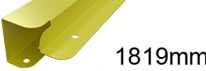

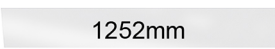
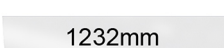

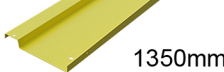

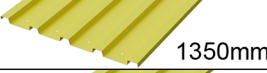
Zamknij korek uszczelki

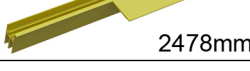

Nanieść zabezpieczenie
antykorozyjne na krawędź cięcia











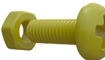



LISTA ELEMENTÓW

NR.	CZĘŚCI	ILOŚĆ
K2		4
K9	 2604mm	2
K4		4
K8	 2444mm	2
K7	 2059mm	4
13	 2542mm	2
K16		4
K17		4
KQ	 2520mm	4
C3	 2495mm	4
1	 2481mm	4
1-1	 2481mm	4
22	 2649mm	2
21	 1000mm	2
5	 1490mm	1
6	 1490mm	1
20	 2736mm	2
17L	 2737mm	1
17R	 2737mm	1
14-1	 2672mm	1
G9	 1990mm	2
G5	 60mm	2

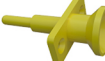
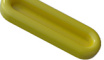

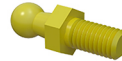



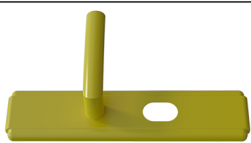

NR.	CZĘŚCI	ILOŚĆ
14	 2720mm	1
7	 1819mm	8
4	 1819mm	2
P7	 1252mm	4
P8	 1232mm	4
P1	 1819mm	12
P2	 1819mm	2
P5	 1350mm	2
P6	 1350mm	2
P10	 1350mm	4
P9	 1350mm	16
C1	 2478mm	8
C9	 194mm	4
C10	 210mm	8
GC	 120mm	4
G11		2
M1		2
M3		2
C21		4

LISTA ELEMENTÓW

NR.	CZĘŚCI	ILOŚĆ
D1	 1770mm	1
D2	 1770mm	1
SX		1
YS		1
SX1	 75mm	1

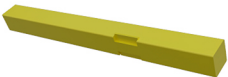
NR.	CZĘŚCI	ILOŚĆ
F1	 ST4.2*10	500
F2	 M4*10	60
F3	 M5*12	26
F5		34
F6		22
S2		120
S3		120
S4		190
F4		10
C20		4
G1		4
B6		4
QD8		4
M8		4
G3		2
FS		2
FS1		4

LISTA ELEMENTÓW

NR.	CZĘŚCI	ILOŚĆ
BW		1
BN		1
BD		2
HZ1		1
HZ2		1
FG		1
FG1		2
FG2		2
FG3		2

PRZEGLĄD MONTAŻU

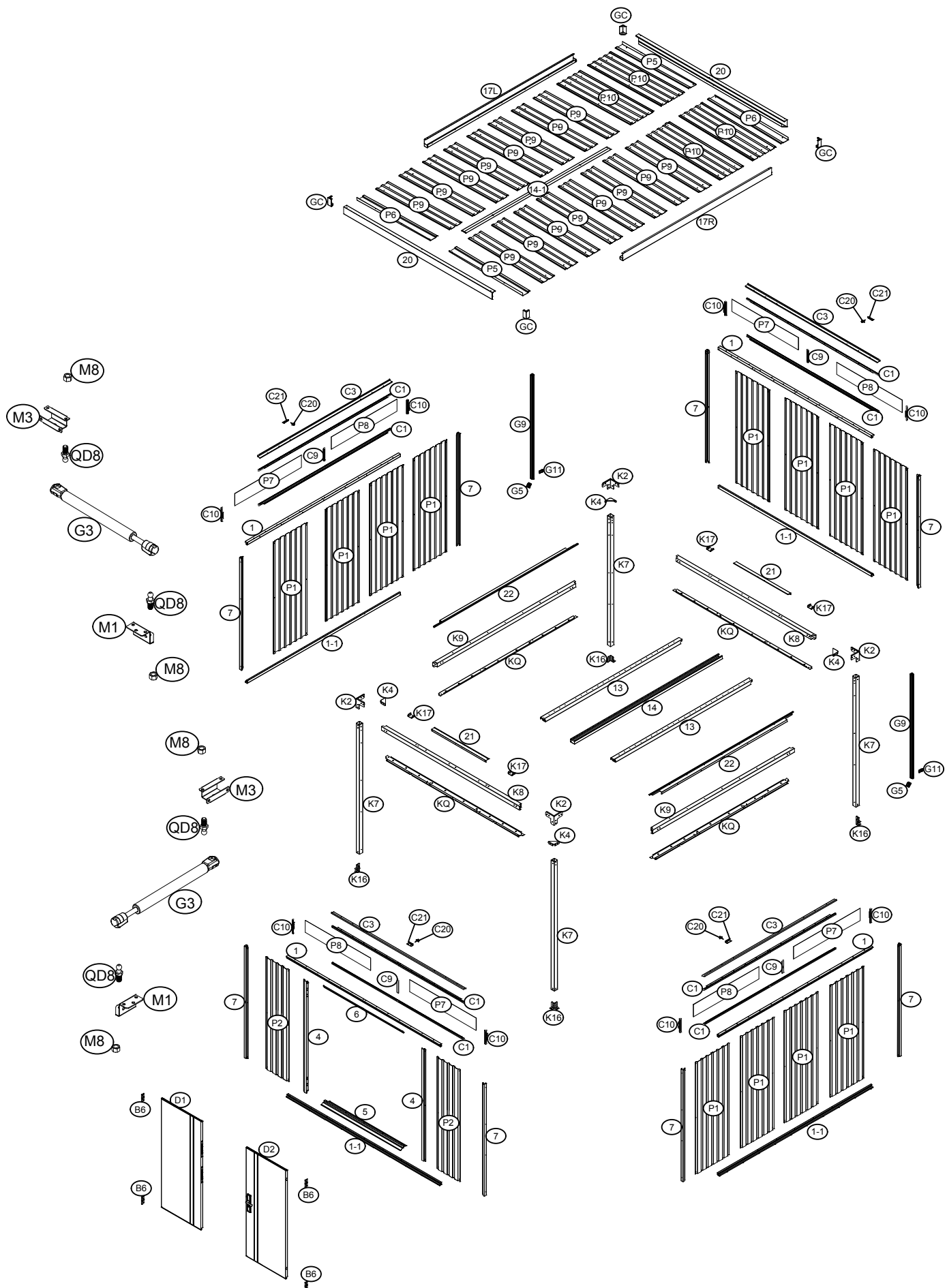

PRAKTYCZNE AKCESORIA – DOSTĘPNE OPCJONALNIE

Rama podłogowa
art. nr 018011

**2. Montaż i
ustawianie domku
narzędziowego na
ramie podłogowej.**



**1. Montaż i
ustawianie ramy
podłogowej.**

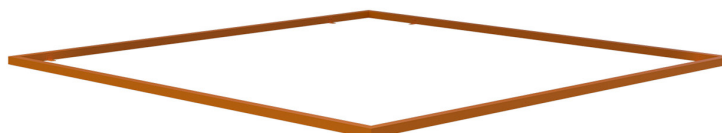

PL

Rama podłogowa z aluminium
art. nr 018012

Jako konstrukcję nośną zalecamy panele XPS o grubo:
4 cm. (niezawarte w zakresie dostawy)

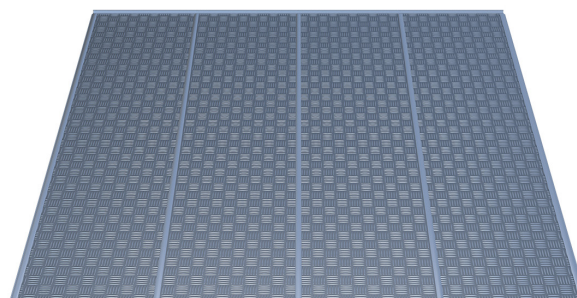

СИСТЕМСКА КУЋИЦА PREMIUM Q7,5 FIRSTLINE УПУТСТВО ЗА МОНТАЖУ

Димензије: L x B x H 274 x 274 x 218 цм



RS

НАМЕНА

Баштенска кућица је намењена за употребу на отвореном и користи се за складиштење баштенског алата, опреме и прибора. Није погодно за смештај људи или животиња или складиштење опасних материја. Баштенска кућица није погодна за комерцијалну употребу. Било каква друга употреба или модификација баштенске кућице сматраће се неправилном употребом и може проузроковати значајне опасности.

НАПОМЕНА

Пажљиво прочитајте упутства за монтажу пре него што почнете са монтажом баштенске кућице.

Ово се посебно односи на безбедносне напомене.

У супротном, можете се повредити или оштетити баштенску кућицу.

По баштенској кућици деца не смеју да се пењу нити пузе. Постоји ризик од преоптерећења.

Уверите се да су све потребне компоненте присутне у наведеној количини.

Извршите појединачне кораке монтаже један за другим и редоследом наведеним у овим упутствима.

Молимо вас да не прескачете или скраћујете ниједан од датих корака.

Чувајте упутства за монтажу на сигурном месту за будуће потребе..

Планирајте монтажу! Ако се користи подни оквир, прво га је потребно инсталирати.

ОПШТЕ ИНФОРМАЦИЈЕ

Пре него што започнете монтажу, уверите се да се поштују смернице/закони који се односе на вас. Планирајте за монтажу најмање 300 до 360 минута. За монтажу су потребне најмање 4 особе. Пре почетка рада, проверите да ли су сви делови присутни у одговарајућој количини. За монтажу користите чисто, сунчано место без превисних грана. Пре почетка монтаже, проверите да ли појединачне компоненте имају оштећења и поставите их тако да буду лако доступне током рада. Најбоље је да мале делове попут завртњи, навртки итд. чувате у посуди како се не би изгубили. Ни под којим условима баштенску кућицу не смете користити као ослонац за махунарке, биљке пењачице и вијугаве биљке, воће, поврће или као држач за конопач за веш. Одржавајте баштенску кућицу без снега и лишћа. **Максимална носивост 150 kg/m².** Баштенску кућицу користите само онако како је описано у овим упутствима за монтажу. Произвођач или продавац не преузимају никакву одговорност за штету насталу неправилном или неодговарајућом употребом. Не постављајте баштенску кућицу директно на траву или неравне површине; уверите се да је површина одговарајућа, носива, хоризонтална и стабилна. Препоручујемо чврсто причвршћивање баштенске кућице за земљу. Уверите се да су сви завртњи затегнути и да је оквир правилно поравнат и нивелисан. Редовно проверавајте да ли су сви завртњи затегнути и по потреби их затегните. **Неки метални делови су прекривени заштитном фолијом. Ова фолија мора бити пажљиво уклоњена пре почетка монтаже.**

БЕЗБЕДНОСНЕ НАПОМЕНЕ

Никада не стојте директно на површини крова, постоји ризик од преоптерећења. Чак ни током монтаже или чишћења. Постоји опасност за децу и особе са ограниченим физичким, сензорним или менталним способностима (нпр. преморене особе, особе са делимичним инвалидитетом, старије особе са смањеним физичким и менталним способностима) или без искуства и знања (нпр. старија деца). Приликом монтаже баштенске кућице користе се ситни делови попут завртњи и навртки и представљају опасност од гушења ако се прогутају. Баштенску кућицу сме да склапа само квалификовано особље, а не деца или особе са ограниченим менталним или моторичким способностима или недостатком искуства. Неправилно руковање може довести до повреда или материјалне штете. Будите пажљиви приликом распакивања појединачних компоненти из амбалаже. **Постоји ризик од повреда од оштрих ивица.** Појединачне компоненте су направљене од метала и стога су тешке. Ако непажљиво отворите амбалажу, на пример оштрим ножем или другим оштрим/шилјатим предметом, постоји ризик да оштетите компоненте. Након распакивања компоненти, проверите да ли су сви појединачни делови присутни у исправној количини. Поставите појединачне делове на ћебе или слично како бисте избегли огреботине на премазу. Проверите да ли су појединачне компоненте у беспрекорном стању или да ли су оштећене. У том случају, немојте користити оштећене или деформисане делове. Увек носите заштитну одећу током монтаже и постављања. Основна опрема укључује заштитне ципеле, заштитне рукавице, заштитне наочаре и кацигу. Не постављајте баштенску кућицу у веома ветровитим или кишним данима. Уверите се да компоненте не додирују каблове за напајање. Правилно одложите амбалажу, пластичне кесе или заштитне фолије и држите их ван домашаја деце, опасност од гушења! Поставите баштенску кућицу на равну површину. Уверите се да током монтаже нема деце у опасној зони. Не постављајте баштенску кућицу на места изложена јаким или сталним ветровима. Ради ваше личне безбедности, не би требало да склапате баштенску кућицу ако сте уморни, под утицајем алкохола или припити, ако имате вртоглавицу или се осећате лоше. Када користите електронске уређаје, обавезно следите упутства произвођача за употребу. У баштенској кућици се не смеју користити или складиштити врући уређаји попут роштиља, грејалица, горионика итд.; опасност од пожара! Никада не стојте у баштенској кућици или близу ње током олуја или грмљавине. Постоји ризик од удара грома.

НЕГА И ОДРЖАВАЊЕ

Редовно чистите површину. Ако приметите било какве огреботине на површини, одмах их уклоните одговарајућим лаком. Не користите агресивна средства за чишћење, четке са металним или најлонским четкама, нити оштре или металне алате попут ножева или шпатула. Користите меке четке за чишћење. Користите хладну, чисту воду.

АЛАТИ И ОПРЕМА

Заштитна одећа (заштитне ципеле, заштитне рукавице, заштитне наочаре, кацига итд.)

Либела

Мерач дужине

Стојеће мердевине (око 1,5 м висине)

Одвијач или кључ са чегрталком

Одвијач на батерије и бушилица са разним додацима

Одвијач

Заптивни материјал

(није укључено у испоруку)

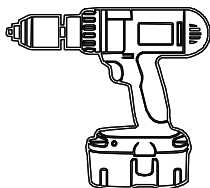
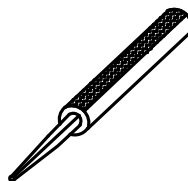
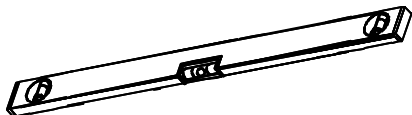
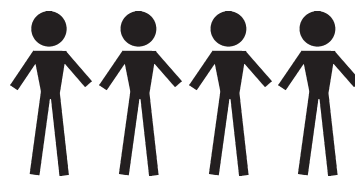

RS

ОДЛАГАЊЕ АМБАЛАЖЕ

Одложите амбалажу одвојено.

Папир и картон се одлажу као отпадни папир, а фолије се односе на одговарајуће сакупљалиште за рециклажу.

ОДЛАГАЊЕ БАШТЕНСКЕ КУЋИЦЕ

Приликом одлагања баштенске кућице, молимо вас да се придржавате прописа који важе у вашој земљи или држави. Смернице, закони и прописи у вези са одлагањем.

ДИМЕНЗИЈЕ

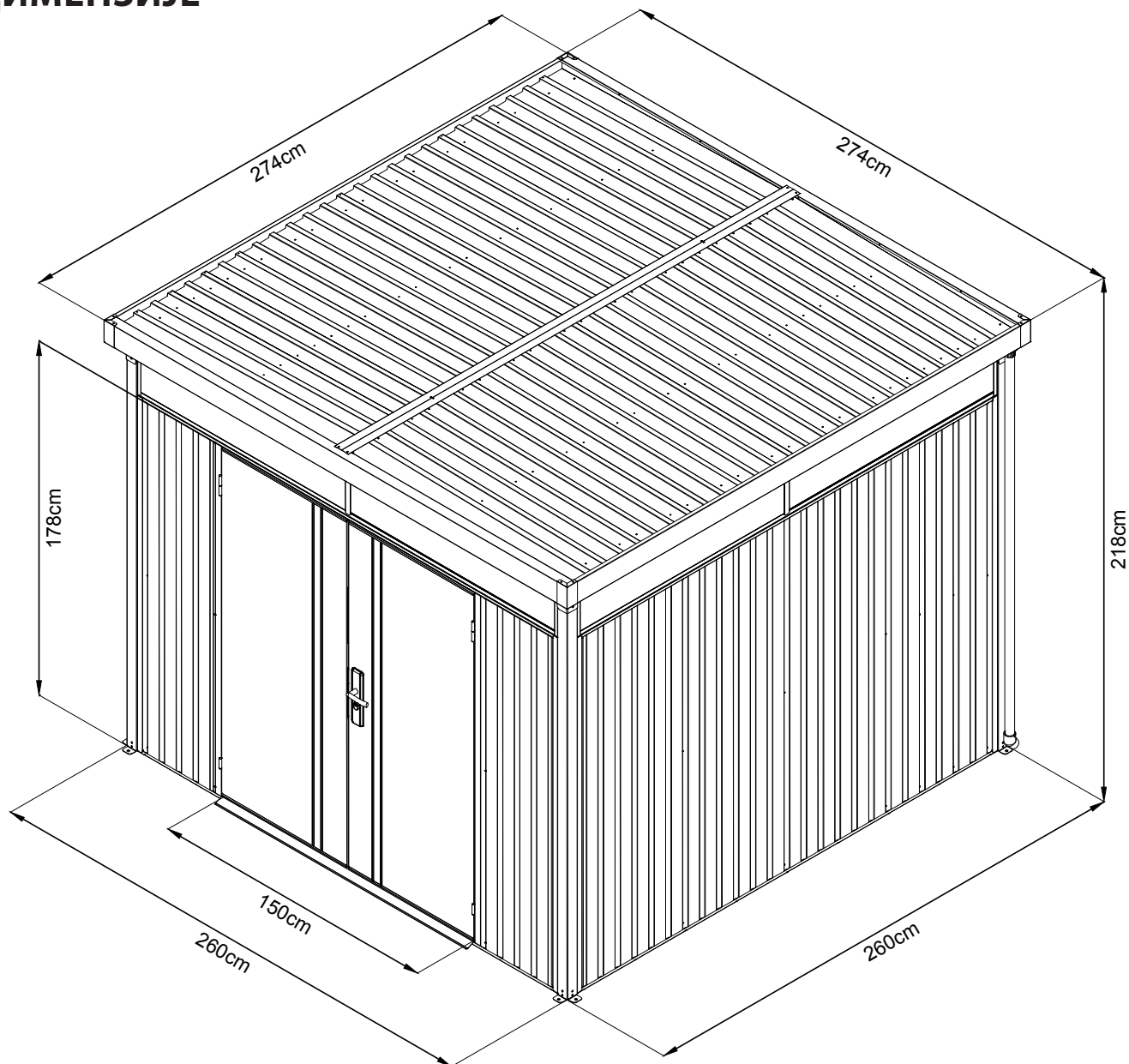

RS

ПОЈАШЊЕЊЕ СИМБОЛА



Монтажа са/ без
подним оквиром ?

+ ?



Монтажа са подним оквиром



Монтажа без подног оквира



Оставите поклопац
отворен





























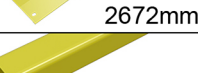





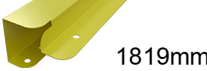

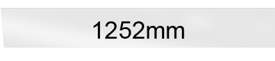
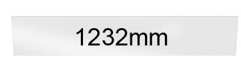

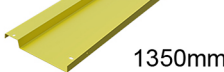

Затвори поглавље

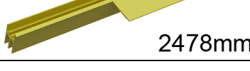

Нанесите заштиту од рђе
на ивицу реза

















СПИСАК ДЕЛОВА

БР.	ДЕО	КОЛИЧИНА
K2		4
K9	 2604mm	2
K4		4
K8	 2444mm	2
K7	 2059mm	4
13	 2542mm	2
K16		4
K17		4
KQ	 2520mm	4
C3	 2495mm	4
1	 2481mm	4
1-1	 2481mm	4
22	 2649mm	2
21	 1000mm	2
5	 1490mm	1
6	 1490mm	1
20	 2736mm	2
17L	 2737mm	1
17R	 2737mm	1
14-1	 2672mm	1
G9	 1990mm	2
G5	 60mm	2

БР.	ДЕО	КОЛИЧИНА
14	 2720mm	1
7	 1819mm	8
4	 1819mm	2
P7	 1252mm	4
P8	 1232mm	4
P1	 1819mm	12
P2	 1819mm	2
P5	 1350mm	2
P6	 1350mm	2
P10	 1350mm	4
P9	 1350mm	16
C1	 2478mm	8
C9	 194mm	4
C10	 210mm	8
GC	 120mm	4
G11		2
M1		2
M3		2
C21		4







СПИСАК ДЕЛОВА

БР.	ДЕО	КОЛИЧИНА
D1	 1770mm	1
D2	 1770mm	1
SX		1
YS		1
SX1	 75mm	1

БР.	ДЕО	КОЛИЧИНА
F1	 ST4.2*10	500
F2	 M4*10	60
F3	 M5*12	26
F5		34
F6		22
S2		120
S3		120
S4		190
F4		10
C20		4
G1		4
B6		4
QD8		4
M8		4
G3		2
FS		2
FS1		4

RS

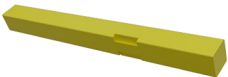
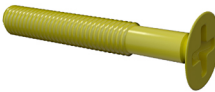
СПИСАК ДЕЛОВА

БР.	ДЕО	КОЛИЧИНА
BW		1
BN		1
BD		2
HZ1		1
HZ2		1
FG		1
FG1		2
FG2		2
FG3		2

ПРЕГЛЕД МОНТАЖЕ

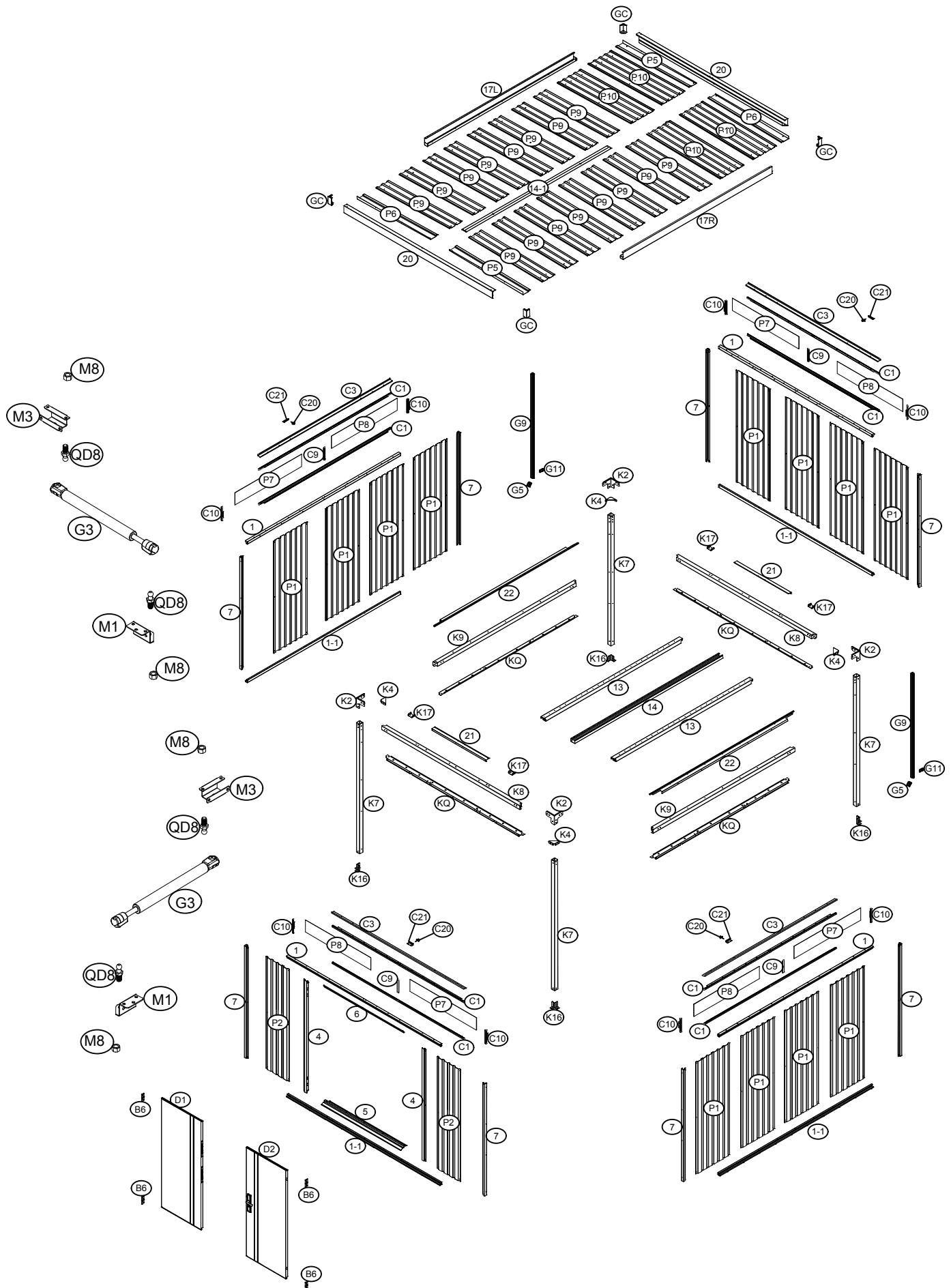

RS

ПРАКТИЧНА ДОДАТНА ОПРЕМА – ДОСТУПНО ОПЦИОНО

Подни оквир
бр.арт. 018011

2. Монтажа и
постављање
баштенске кућице
на подни оквир.



1. Монтажа и
постављање
подног оквира.

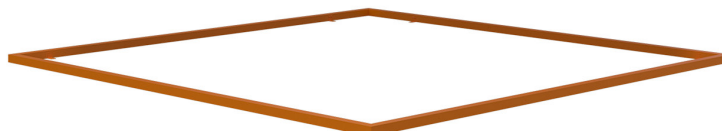



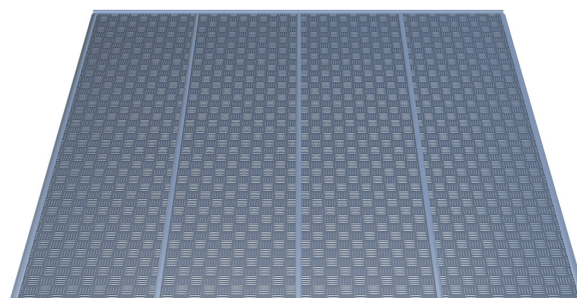

RS

Алуминијумске подне плоче
Бр. арт: 018012

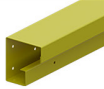
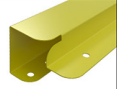
Као подконструкцију препоручујемо XPS плоче
дебљине 4 цм. (није укључено у испоруку)

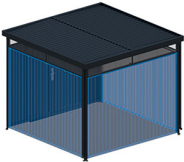
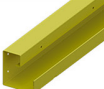

01		1-1 x3		7 x6	 P3.2 x69	 F1 x54	
		1 x3		P1 x12	 F2 x15		

x3

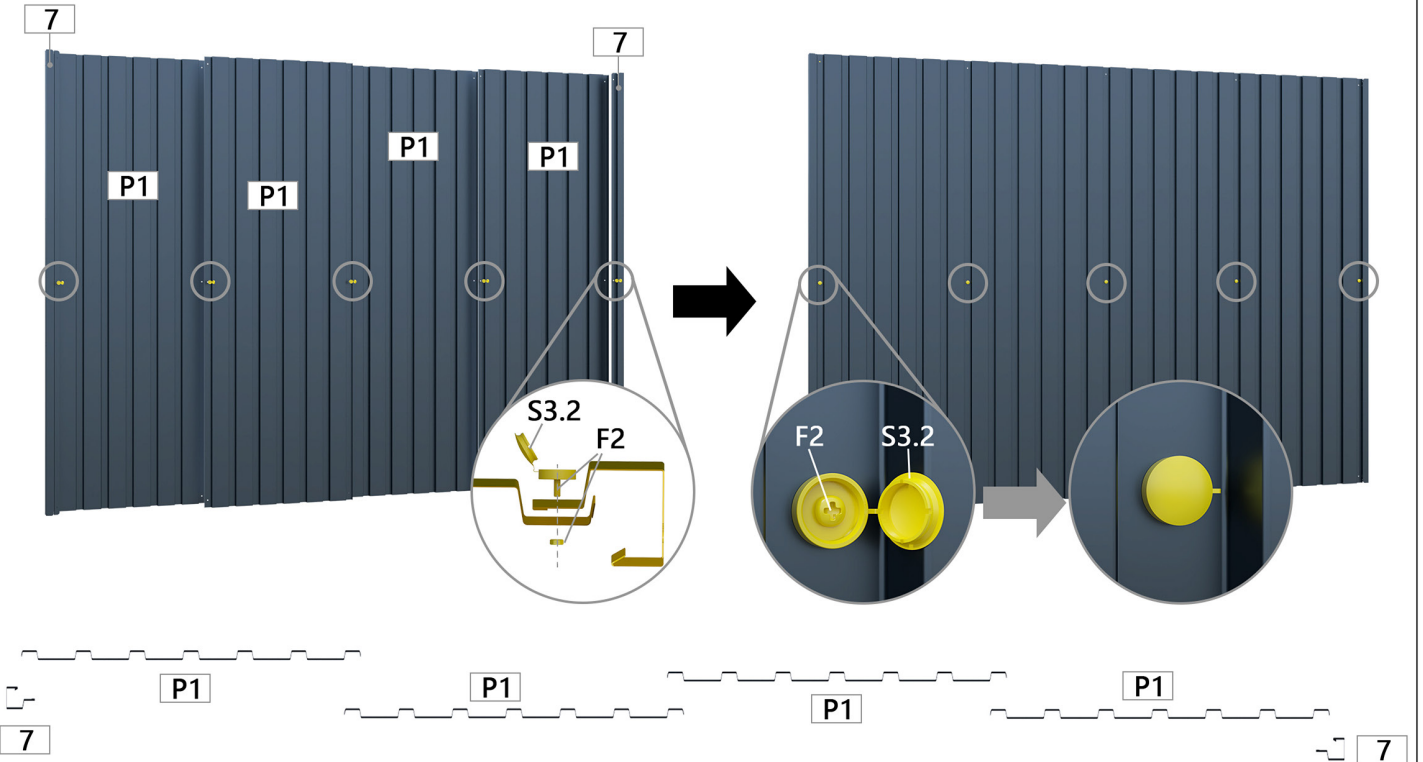

x3

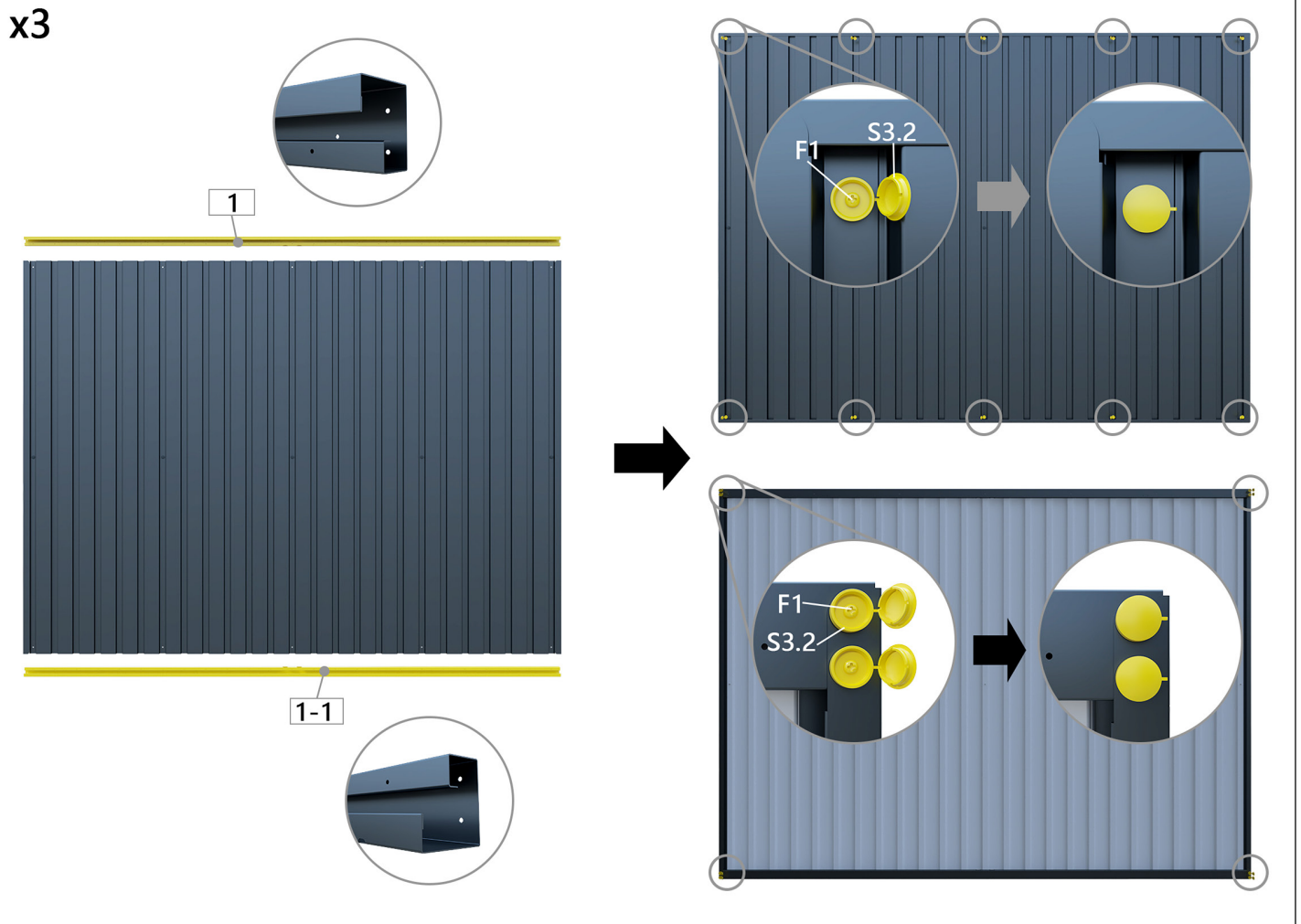

02

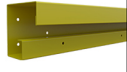

1 x1



1-1 x1

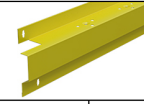

4 x2



P2 x2

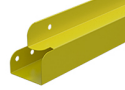

7 x2



F1 x8



F2 x4



S3.2 x12

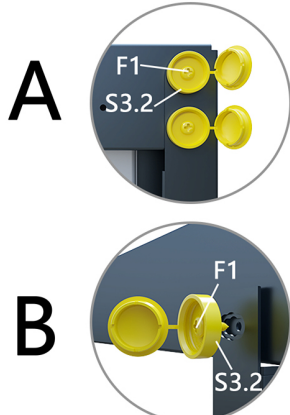
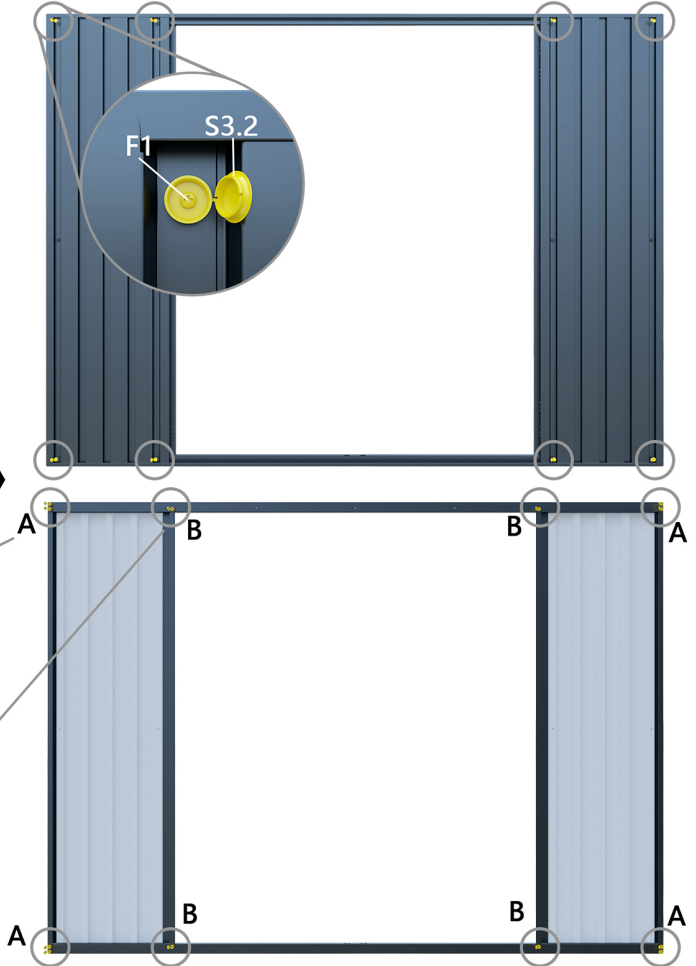
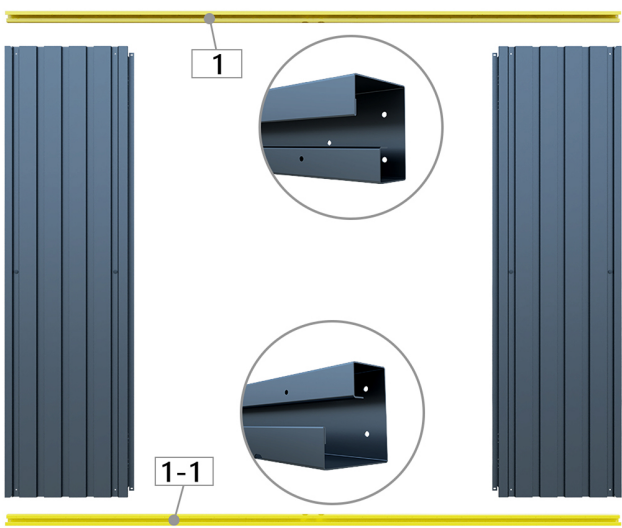
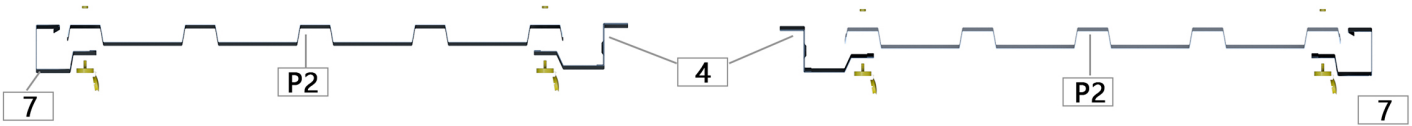
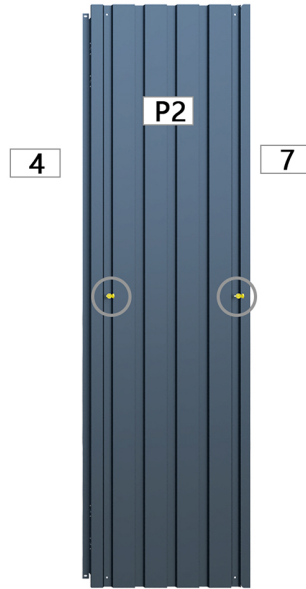
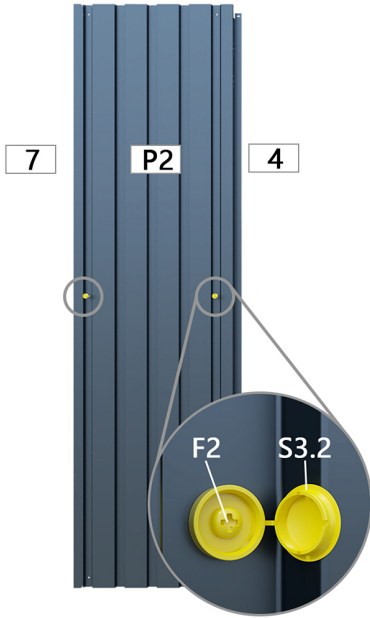

03



K2 x4

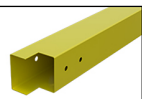

K8 x4



F5 x16



K4 x4

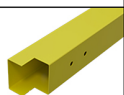

K9 x4

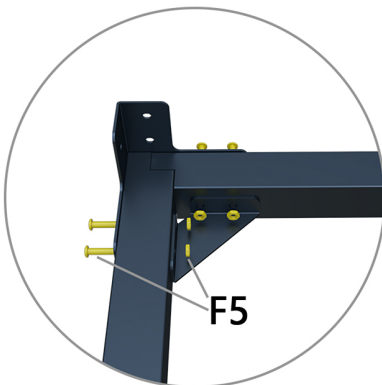
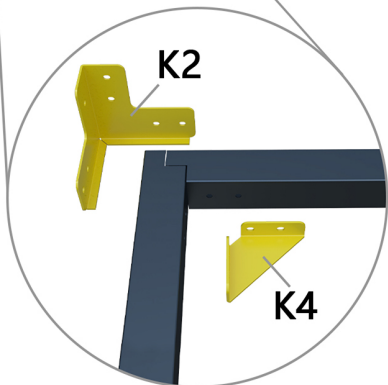
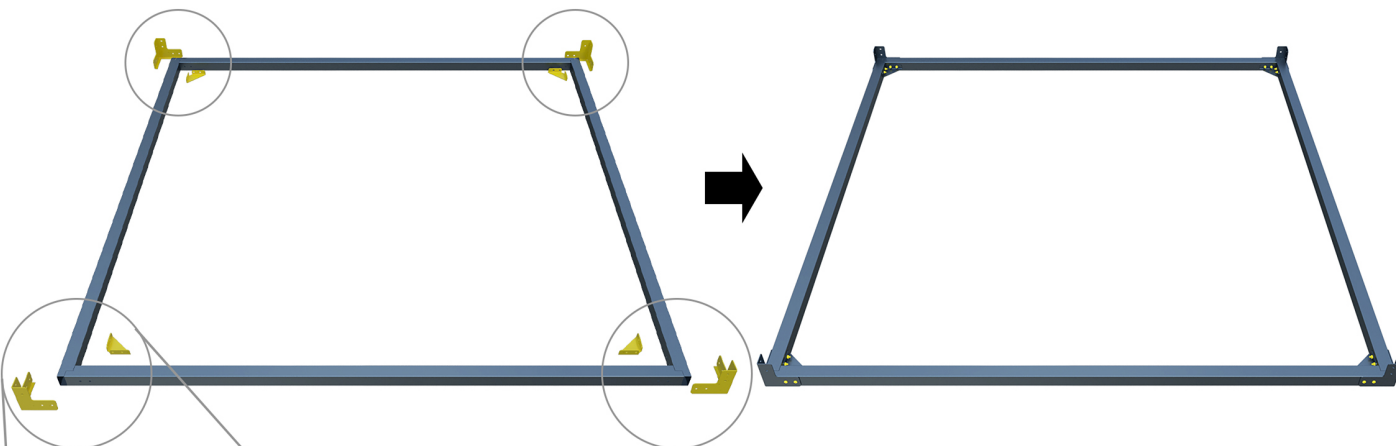
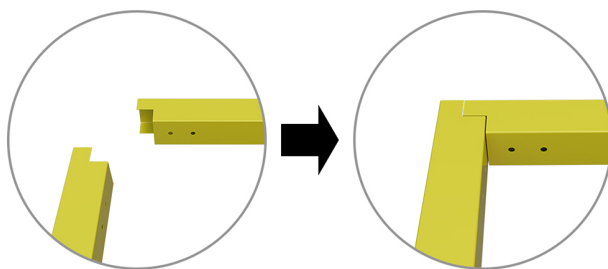
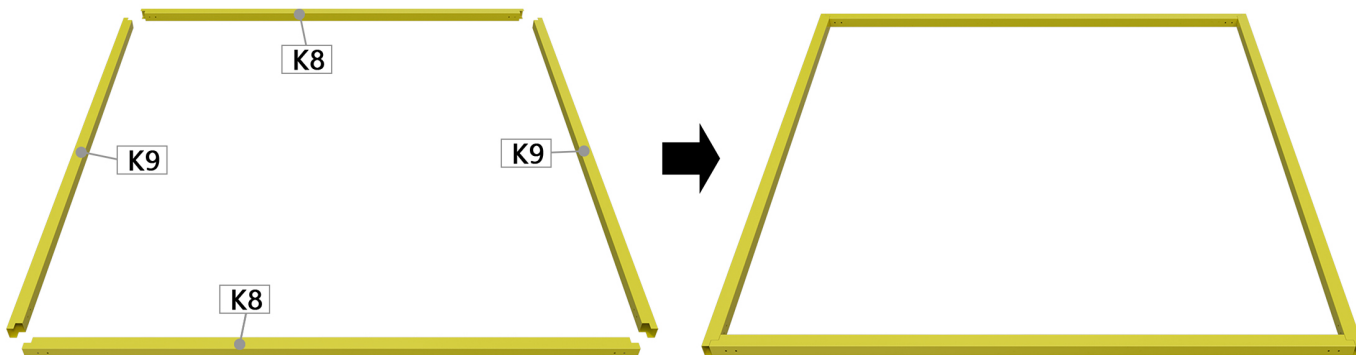
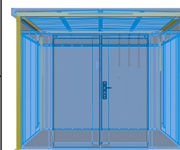

04.1

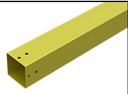

K7 x4



K16 x4



F6 x16

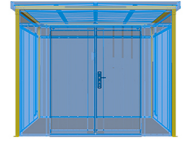

4x

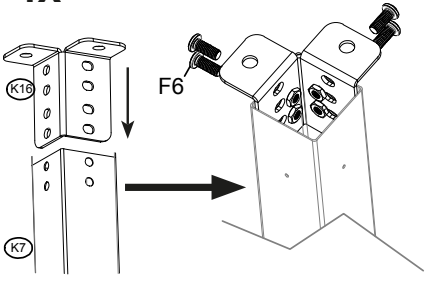

+ ?

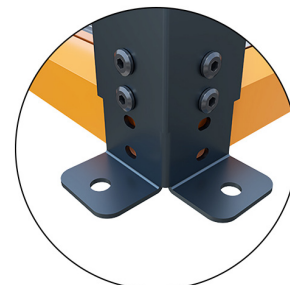
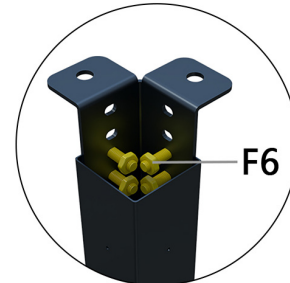
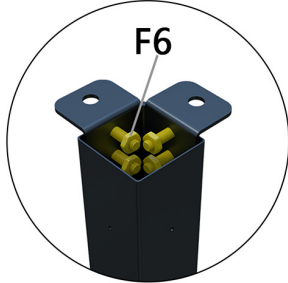
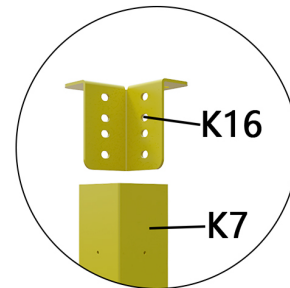
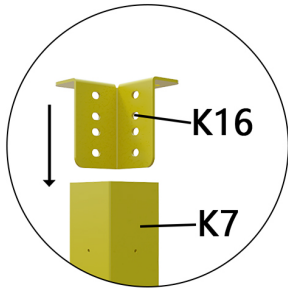
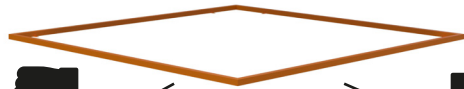

04.2

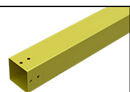

K7 x4



F5 x12



K16 x4

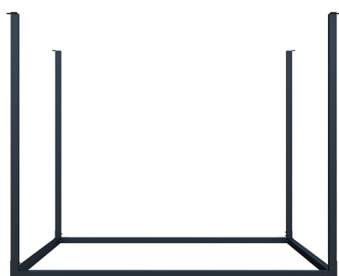
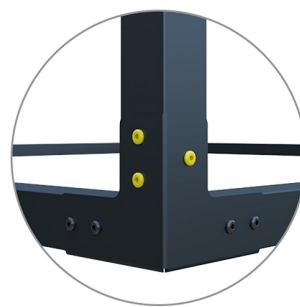
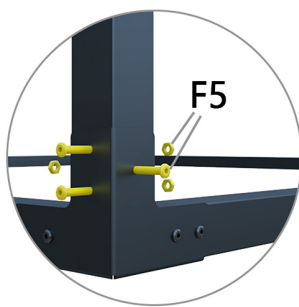
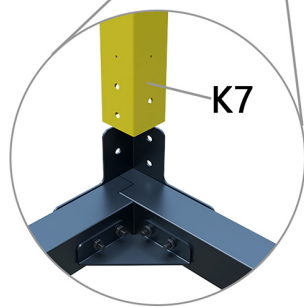
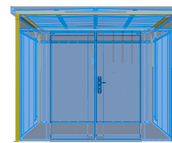



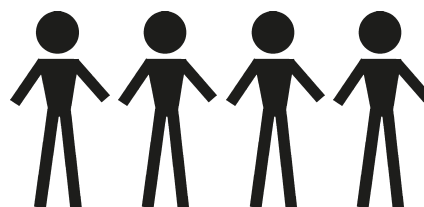
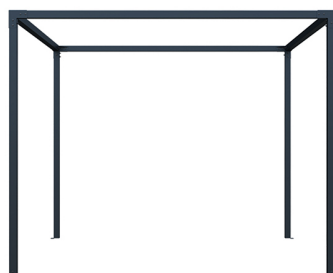

180°

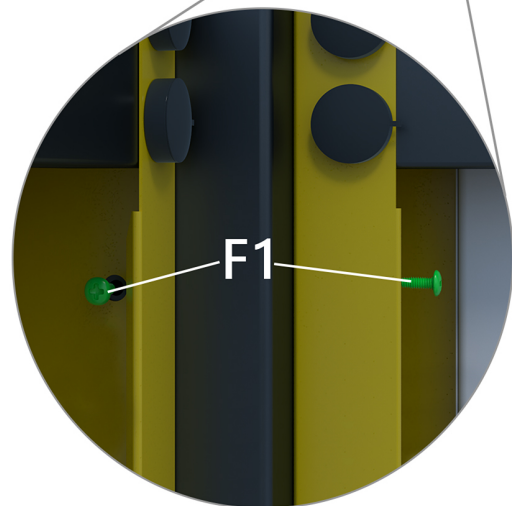
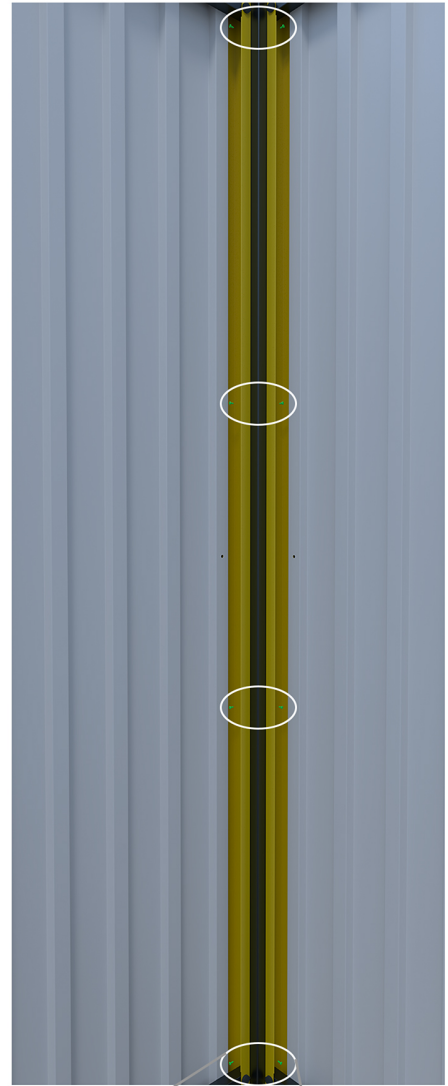
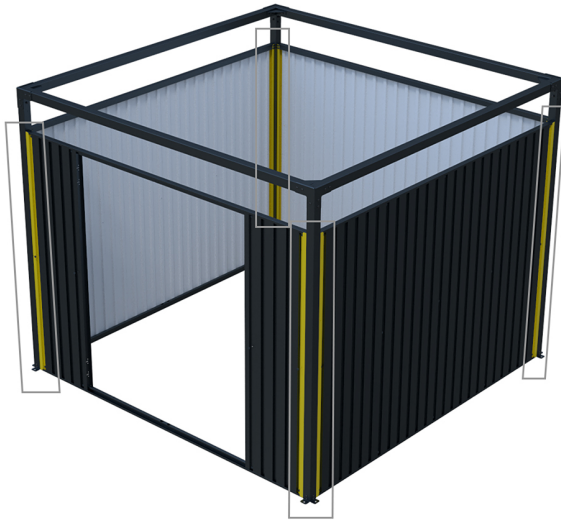
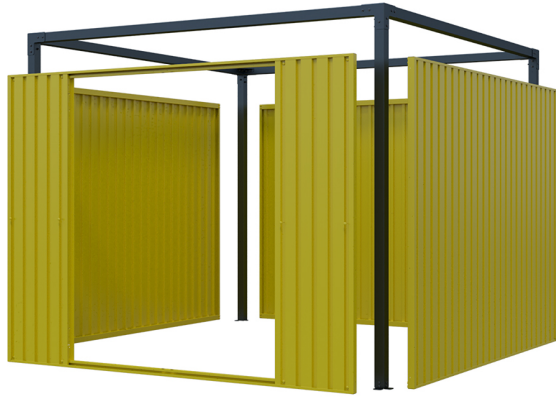
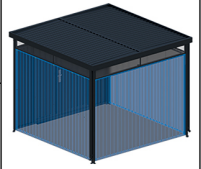

05

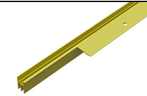
F1 x32

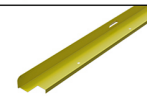

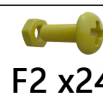
06		C1 x8		C9 x4	1252MM P7 x4	1232MM P8 x4
		C3 x4		C10 x8		

x4

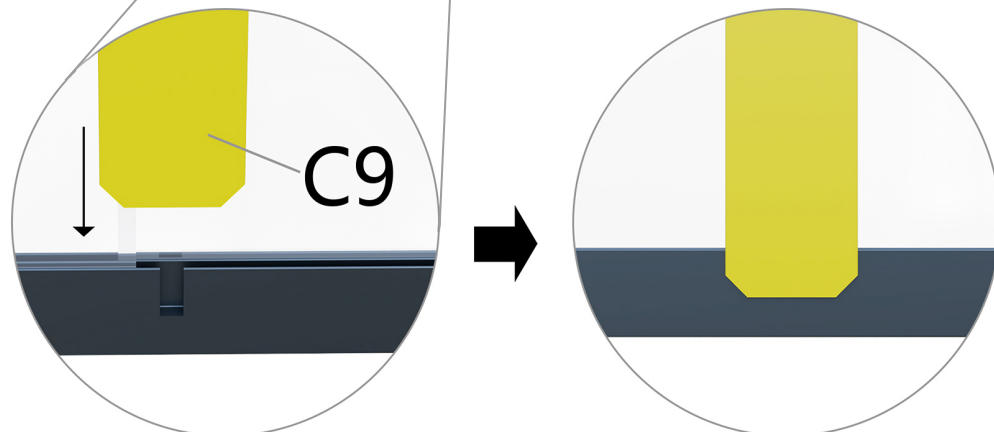
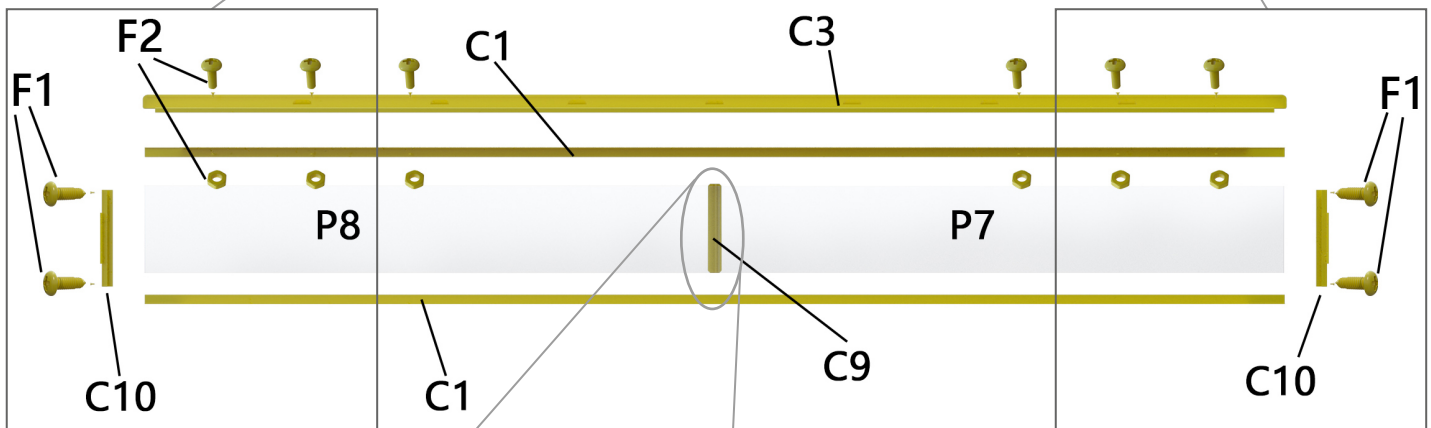
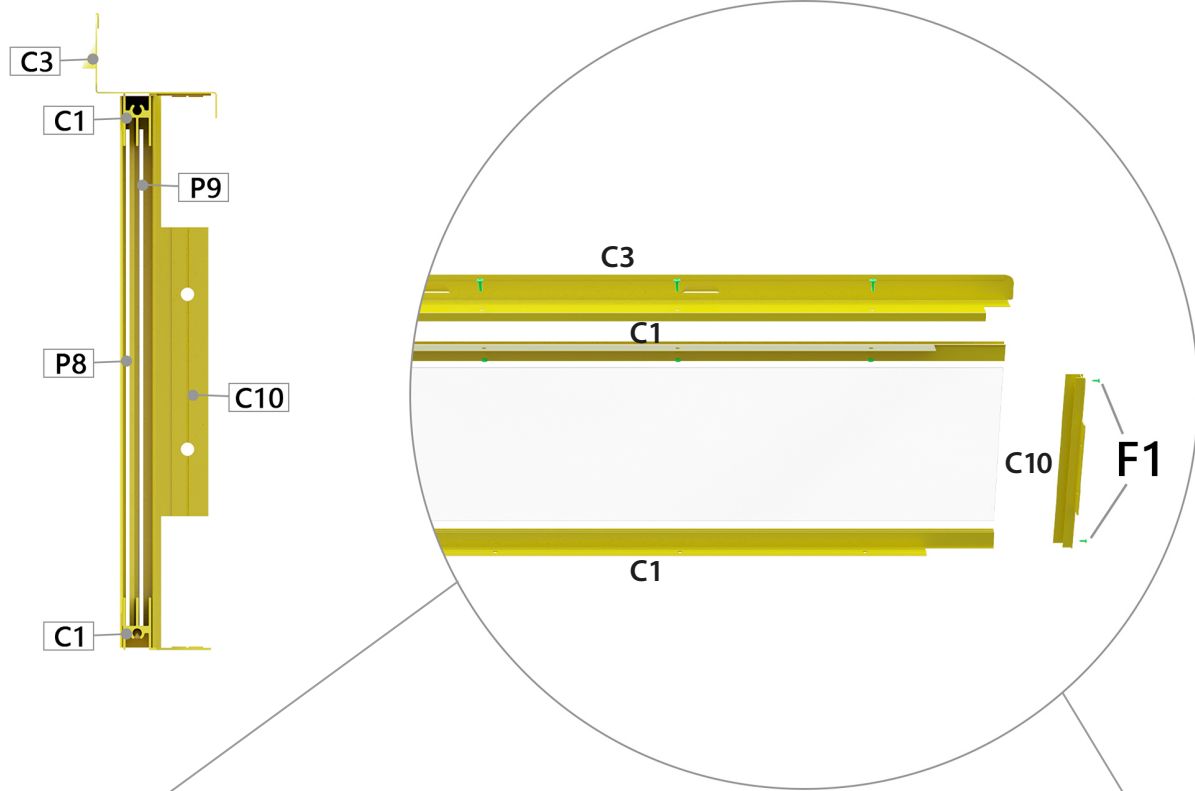

07



C20 x4



G1 x4



F1 x72



C21 x4

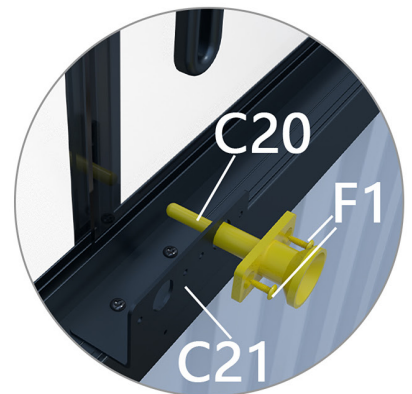
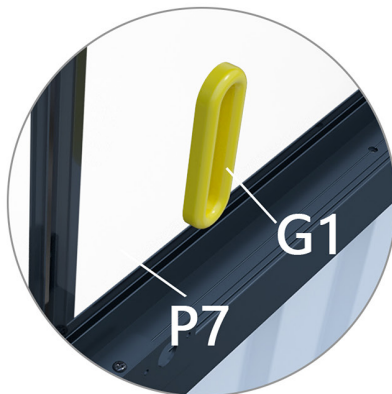
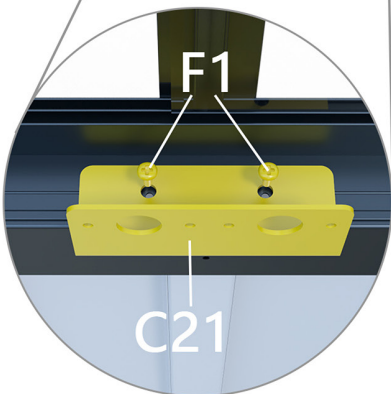
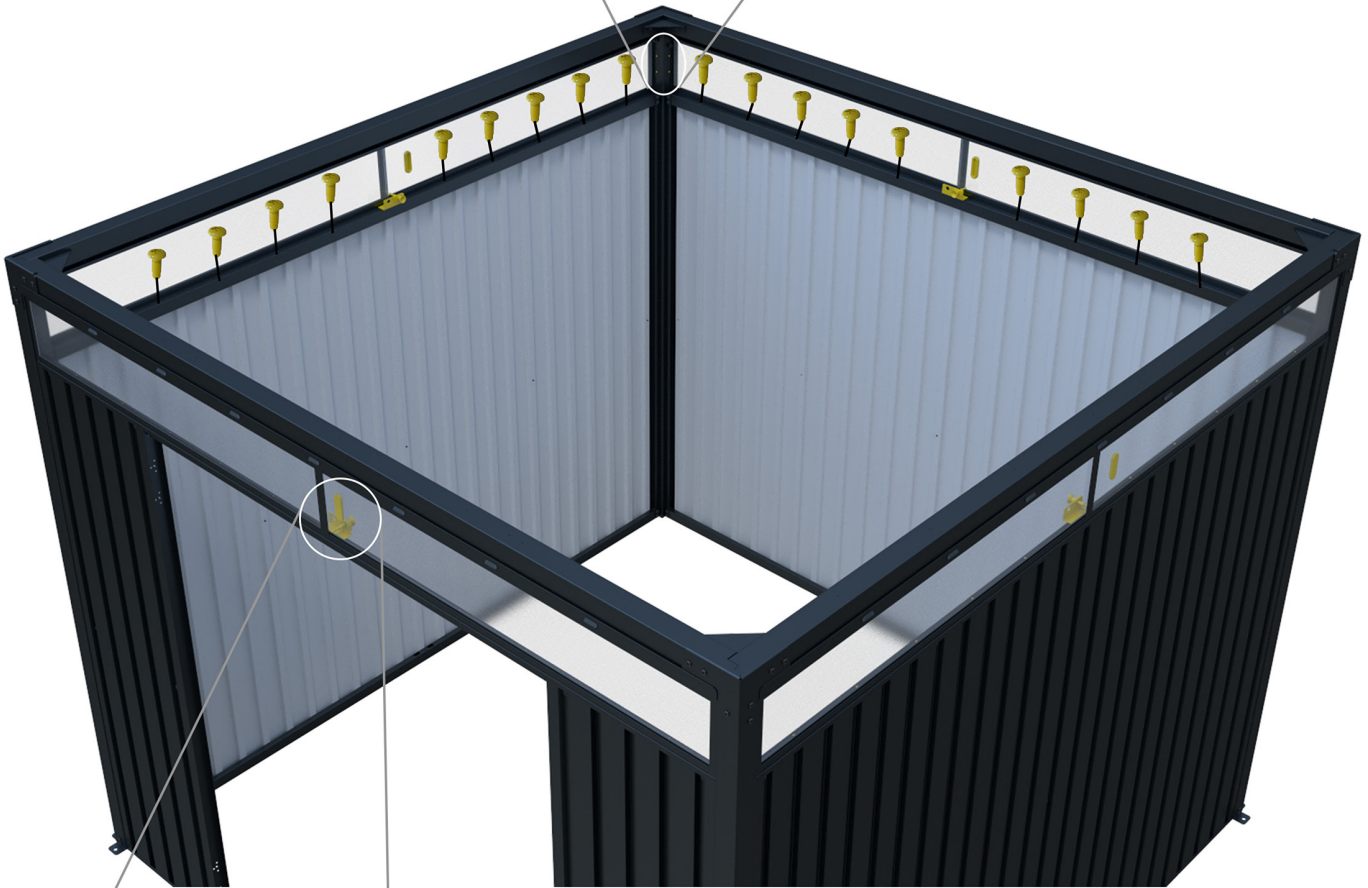
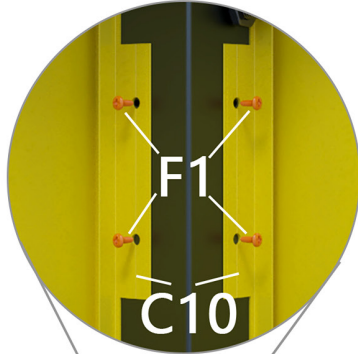
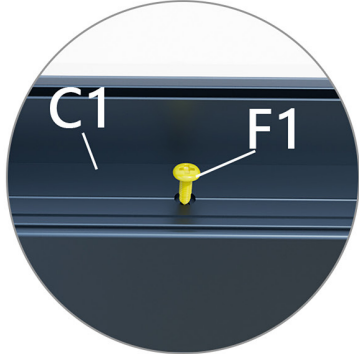
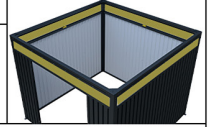

08

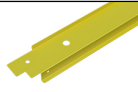

KQ x4



F1 x32



F6 x4

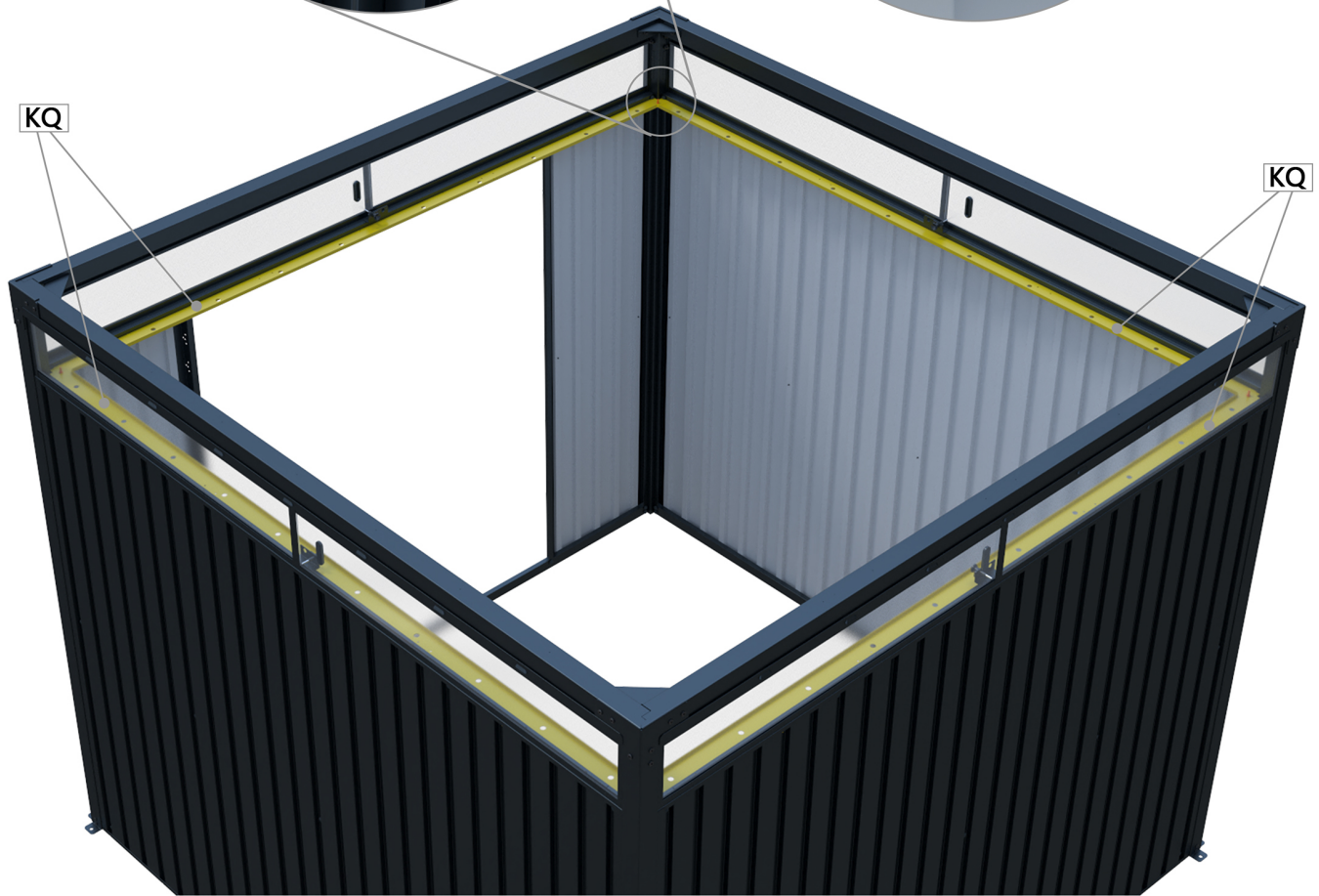
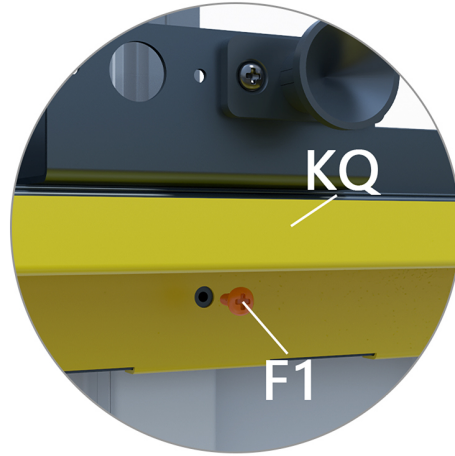
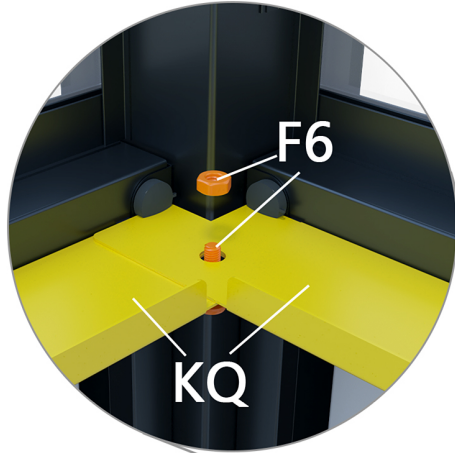
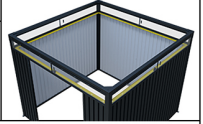

09

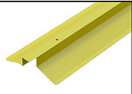

5 x1



F1 x10

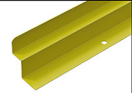

6 x1

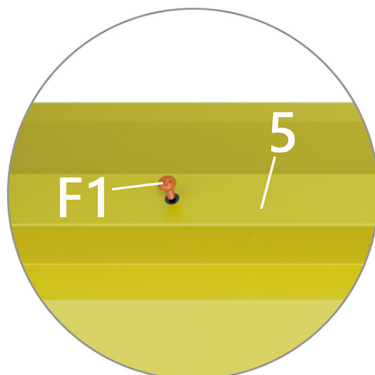
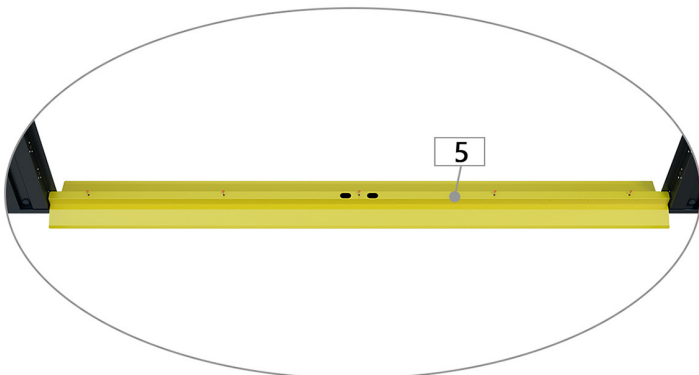
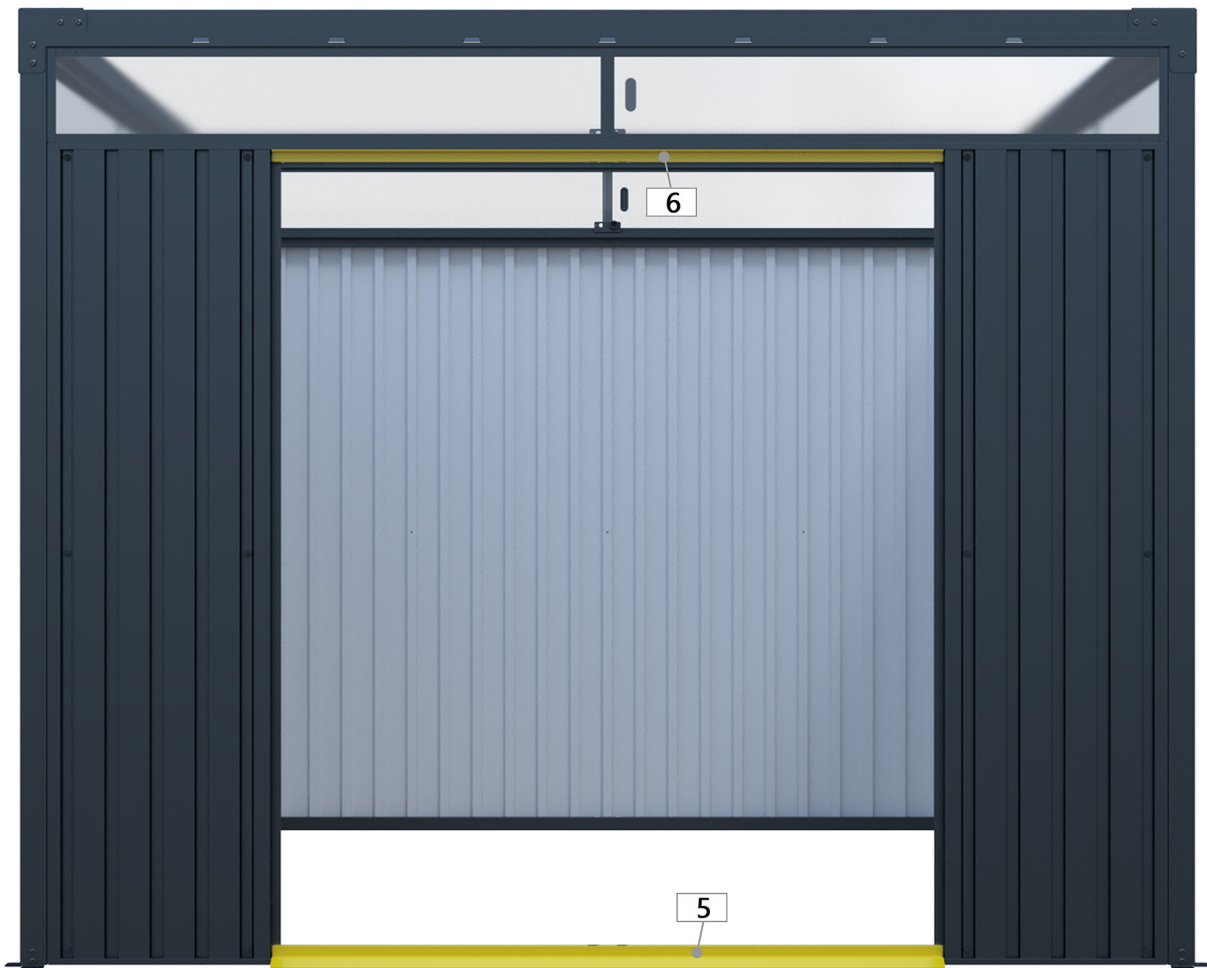
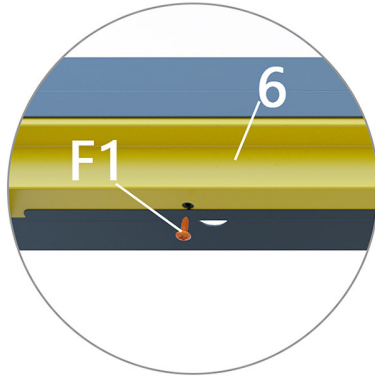
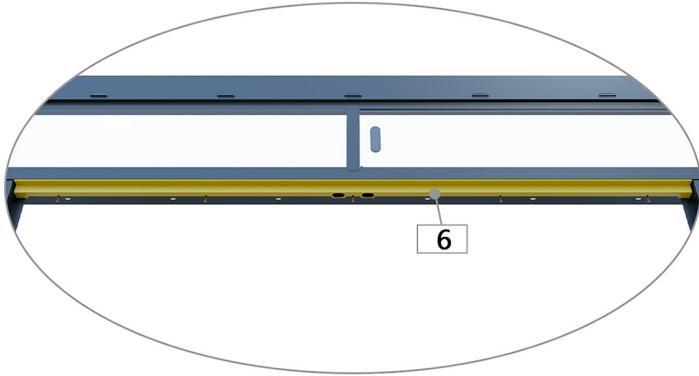

10



K17 x4



F1 x8

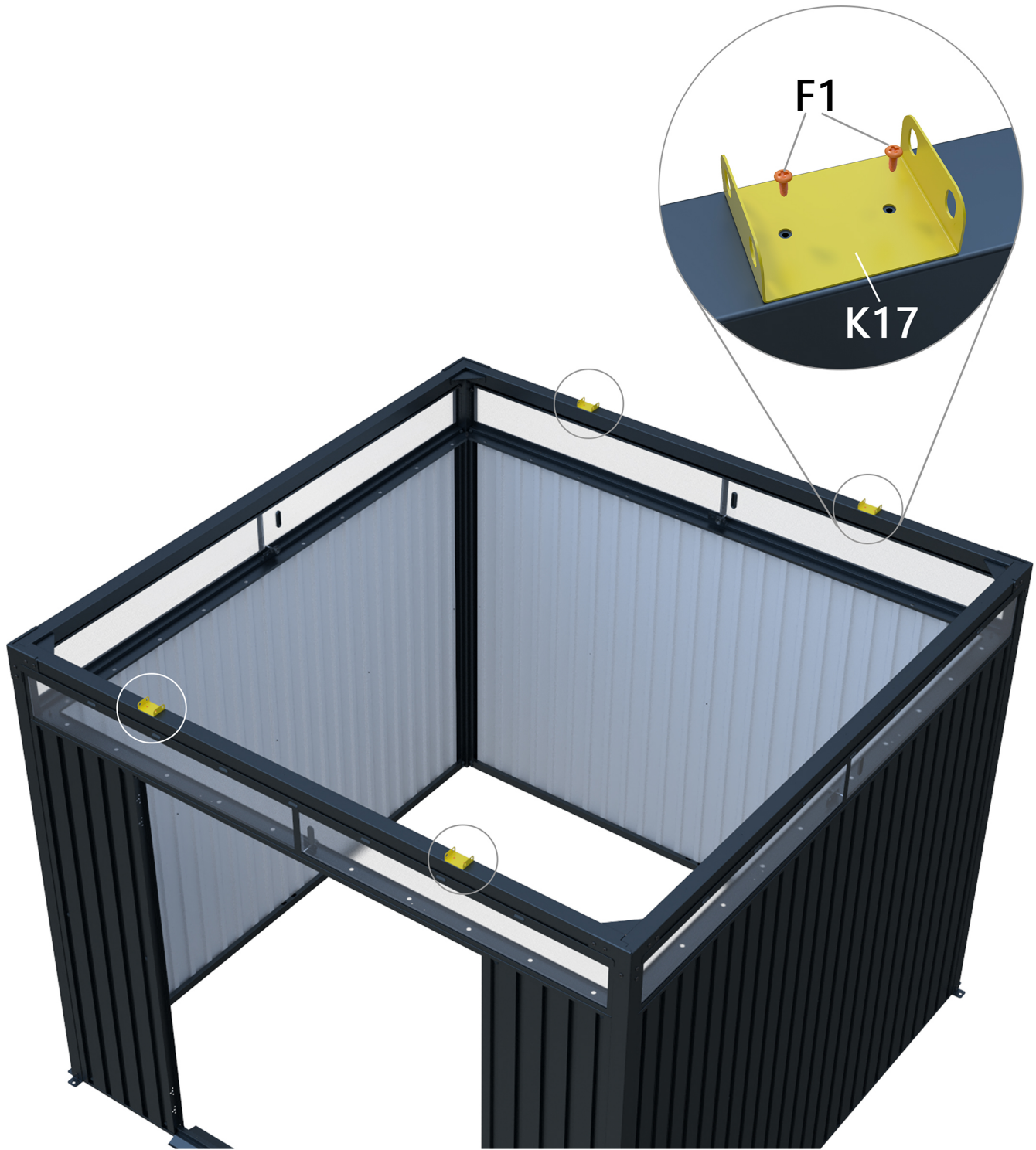
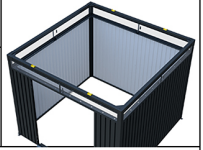

11



M3 x2

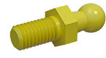

QD8 x2



F1 x4



M8 x2



F2 x4

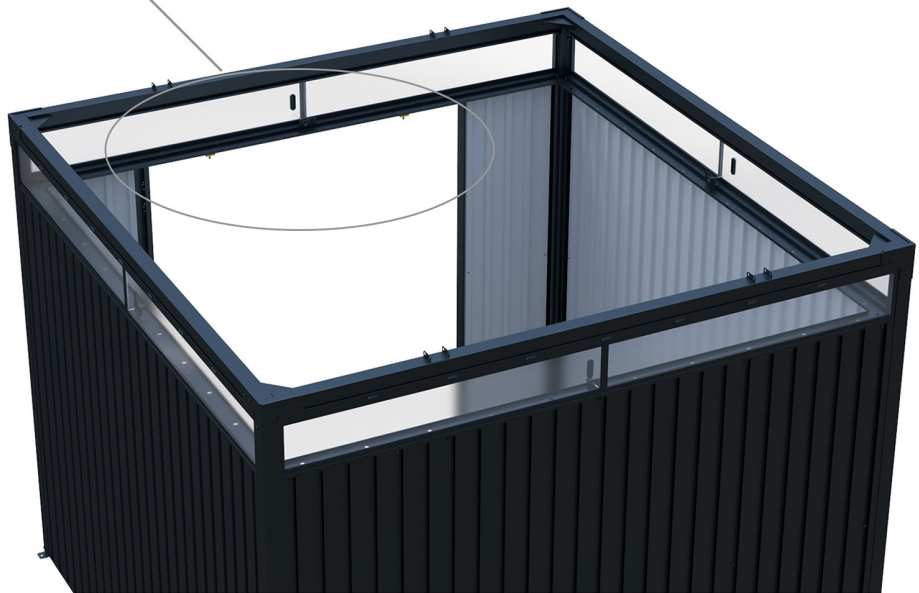
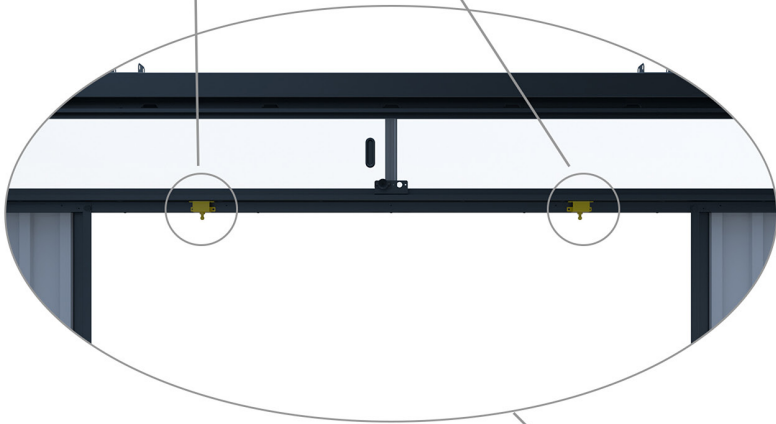
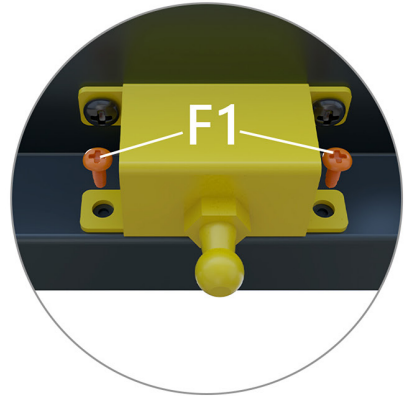
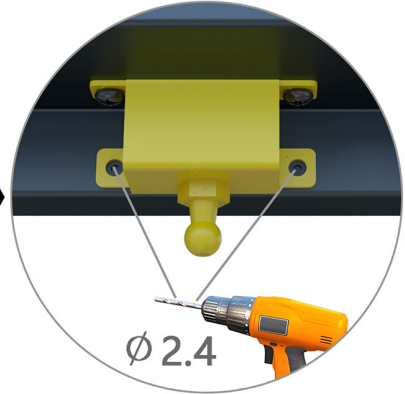
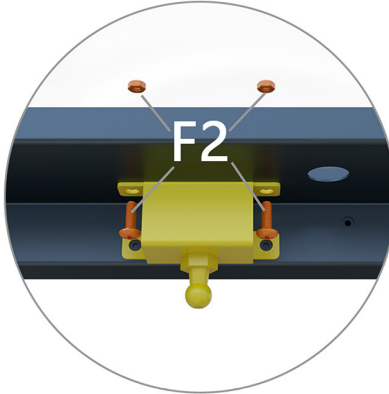
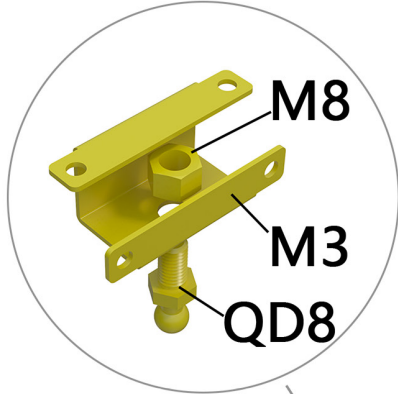

12

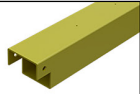



13 x2



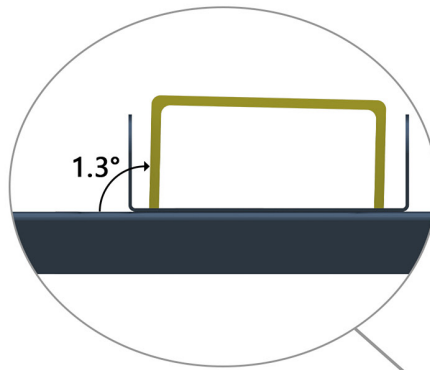
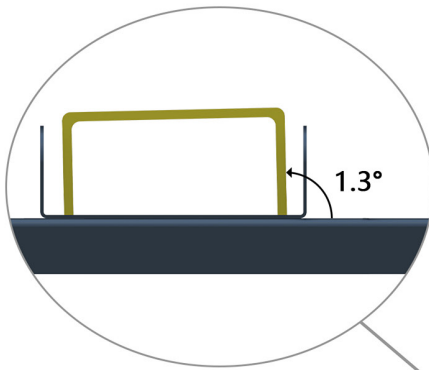
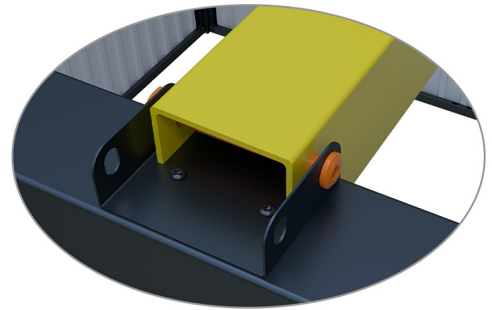
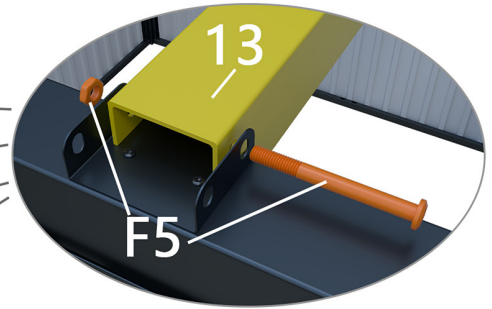
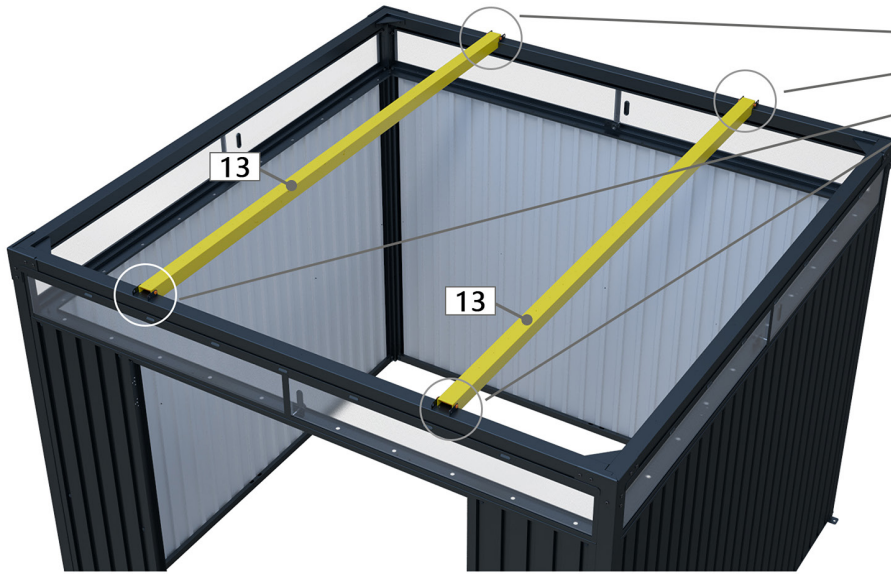
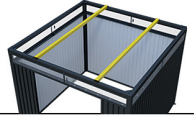

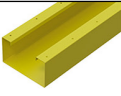
F5 x4

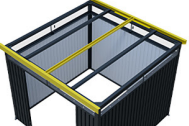
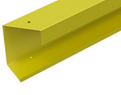

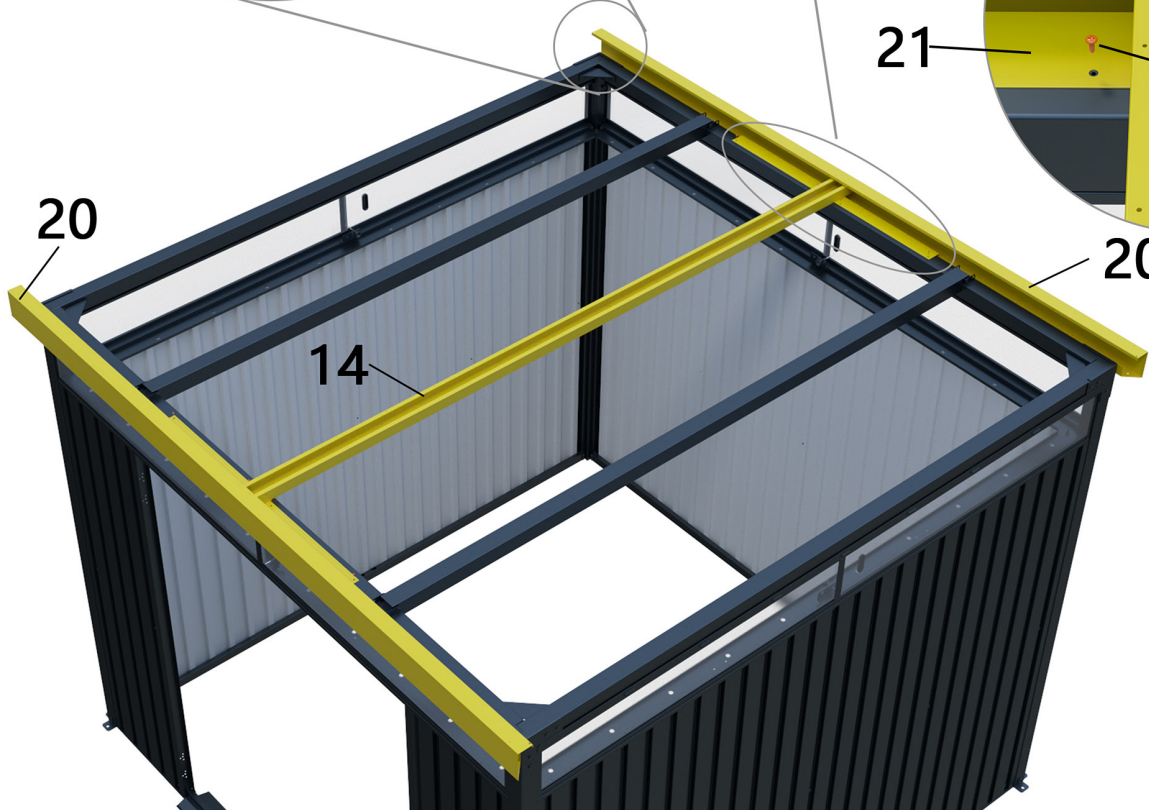
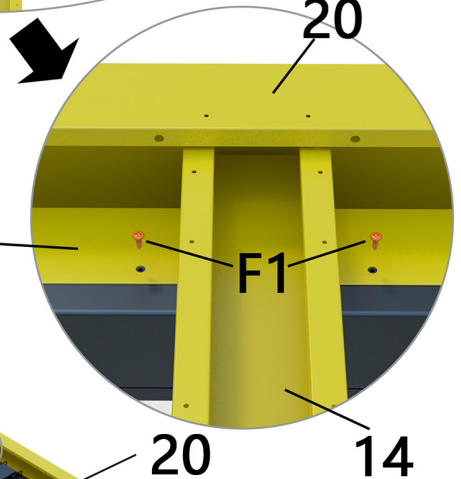
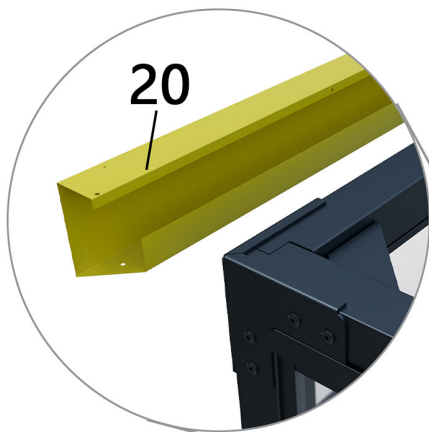
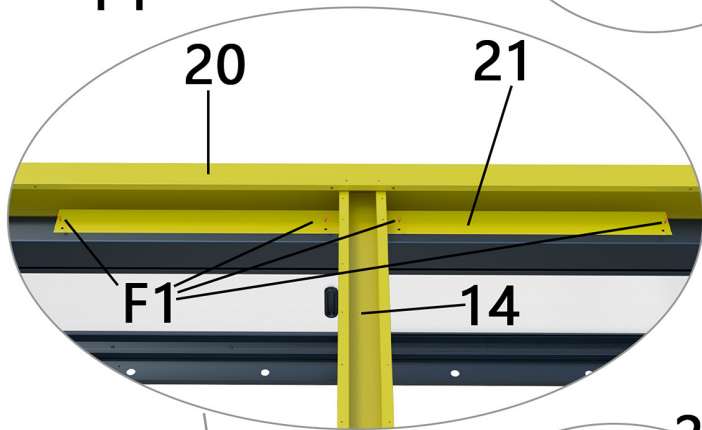
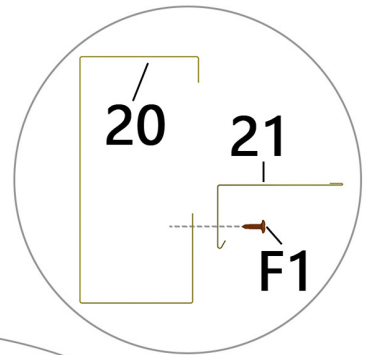
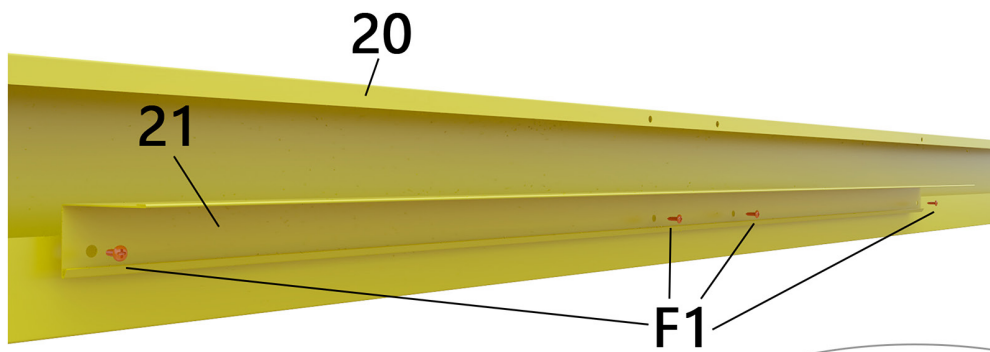
13		14 x1		21 x2		F1 x32	
		20 x2					

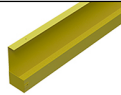
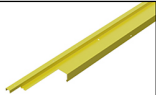

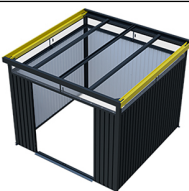
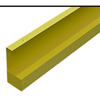

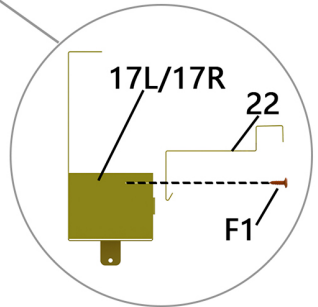
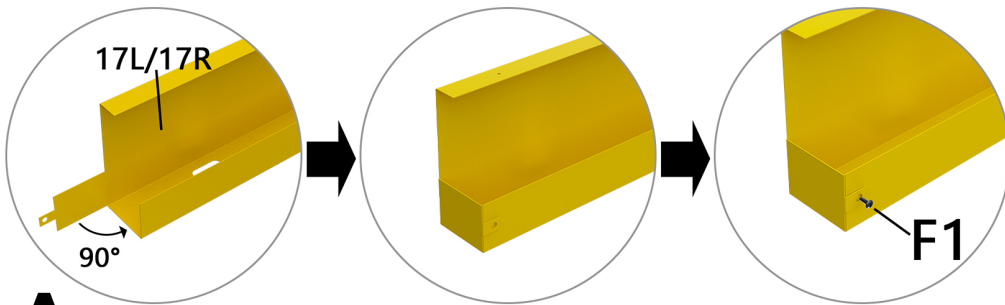

14		17L x1		22 x2		F1 x18	
		17R x1					

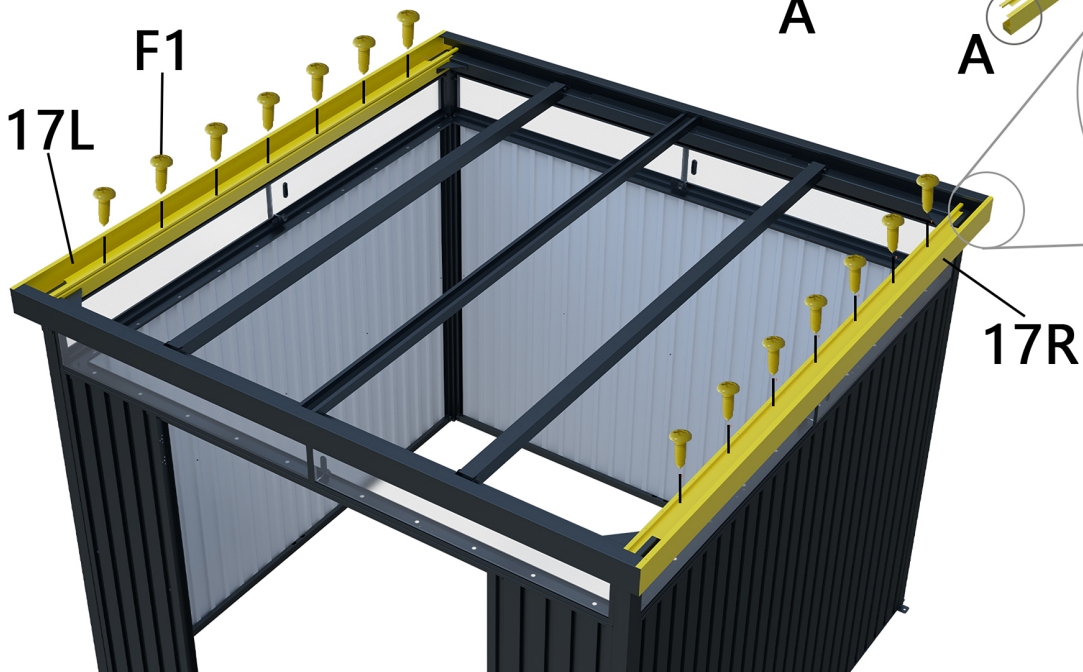
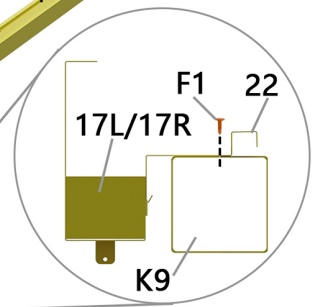
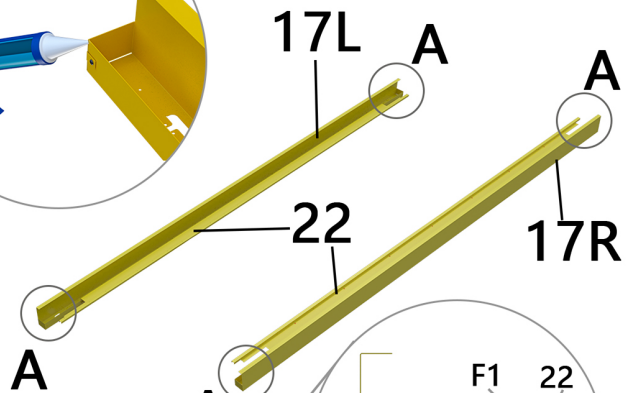
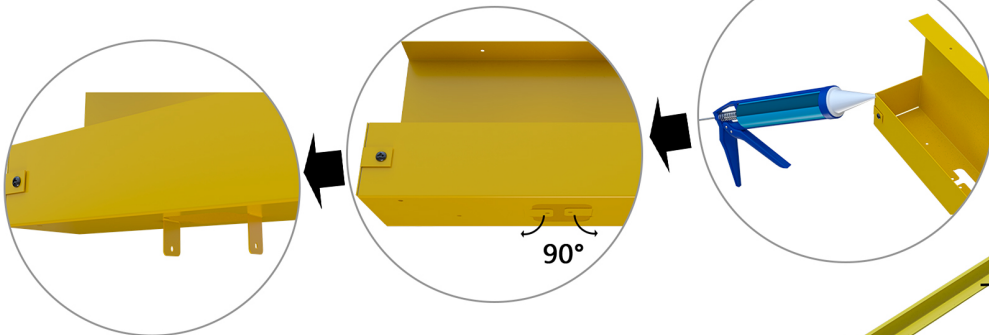

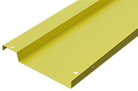
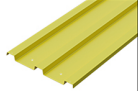
A

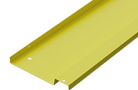
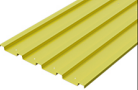

15		P5 x32		P9 x32		F1 x152	
		P6 x32		P10 x32		S4 x152	

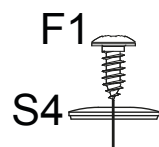
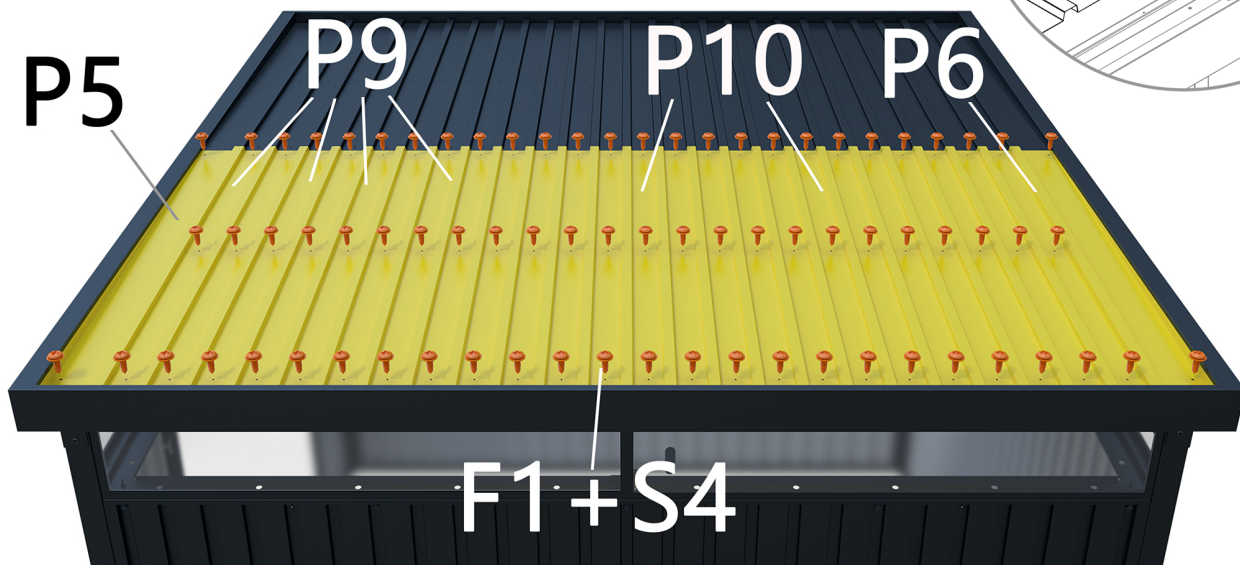
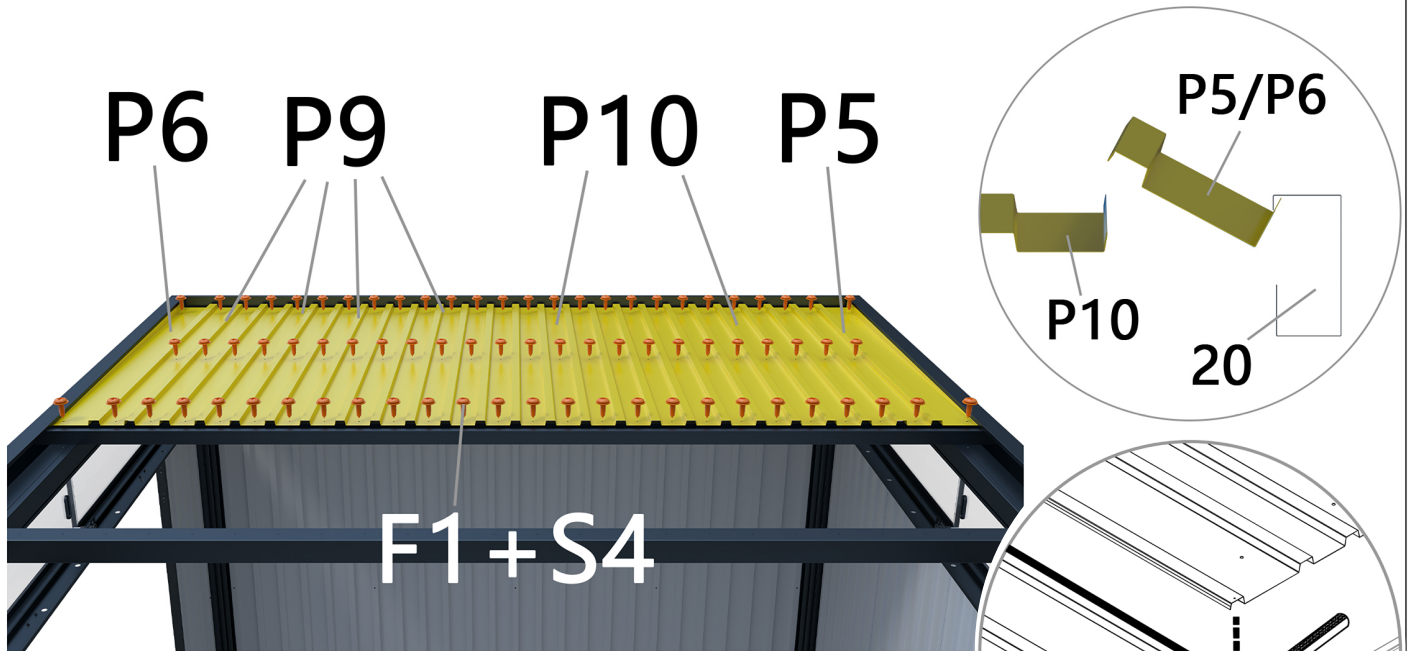

16



GC x4



F1 x28



S4 x28



A

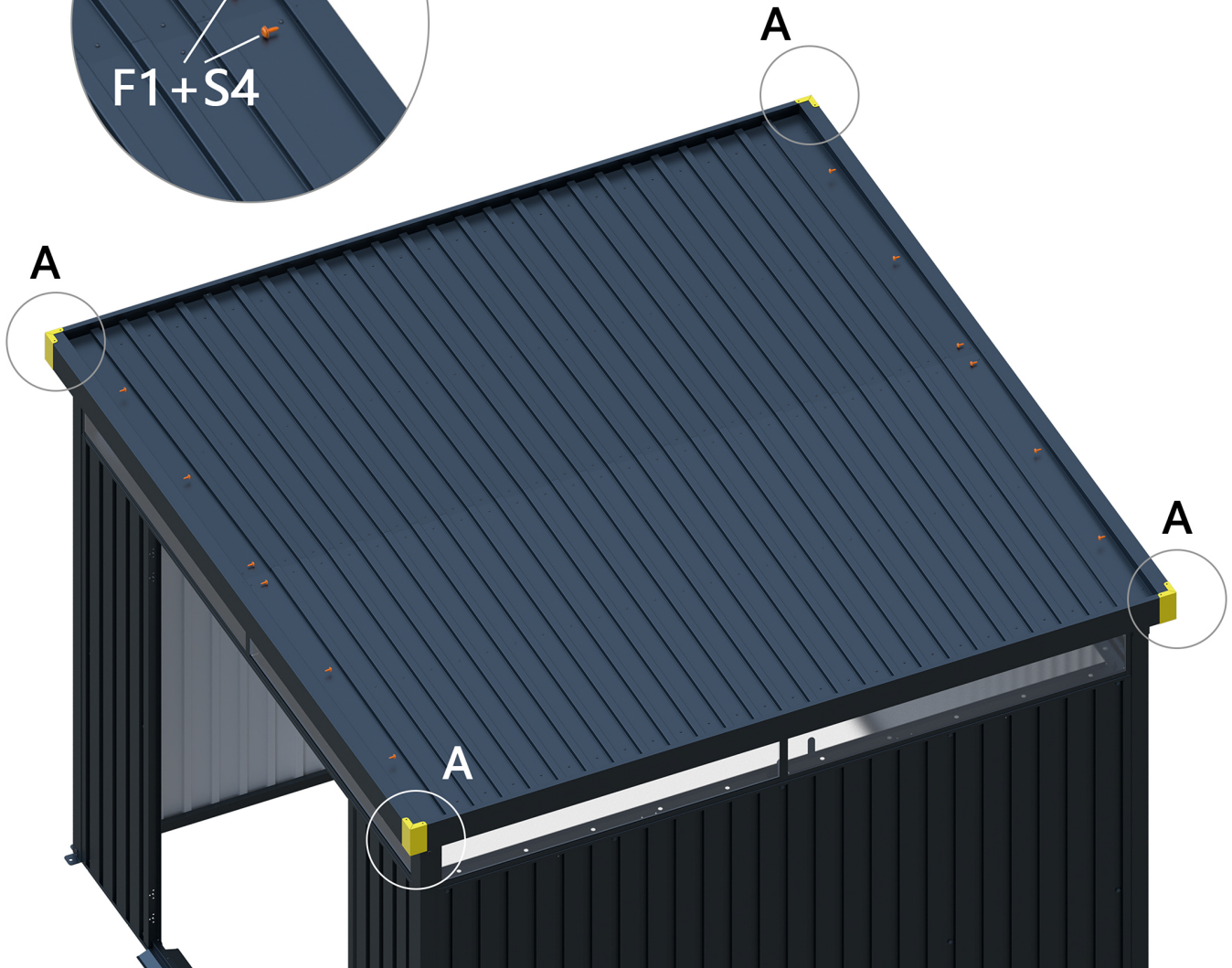
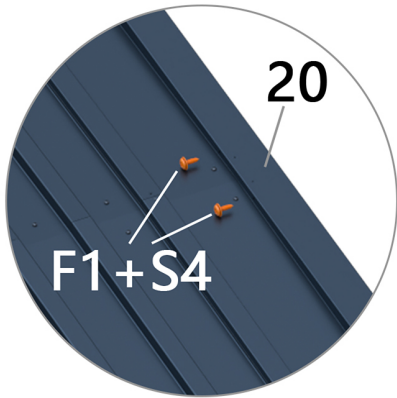
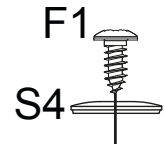
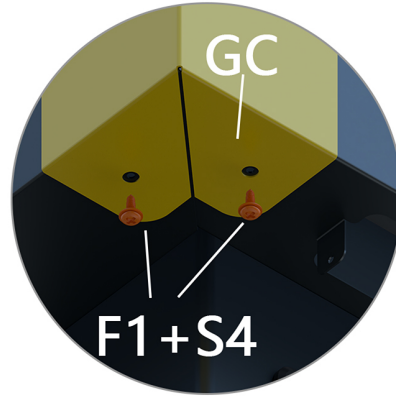
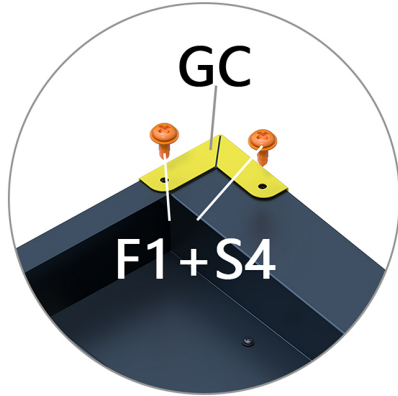

17

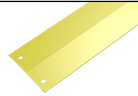

14-1 x1



F1 x8



S4 x28

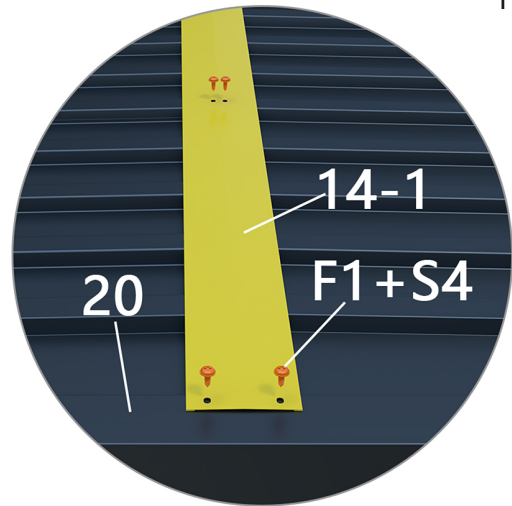
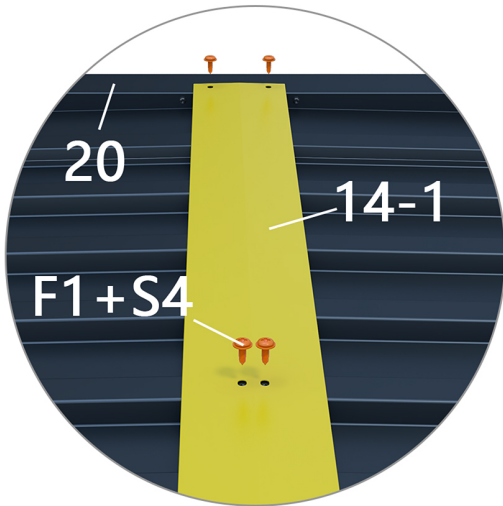
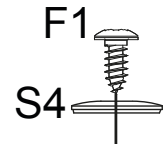

18



G5 x2



G11 x2



FS x2

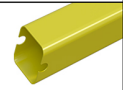

G9 x2







FS1 x2

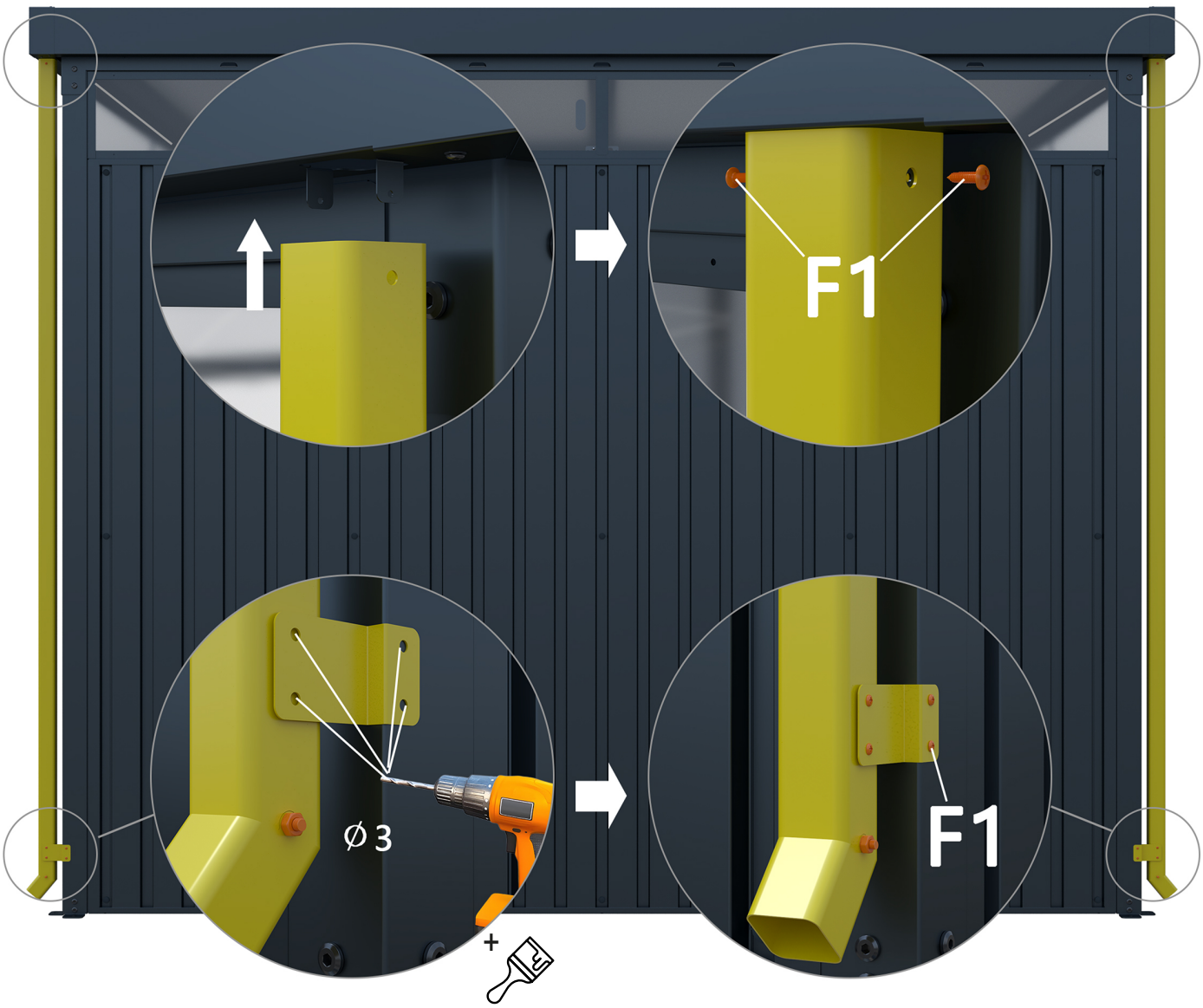
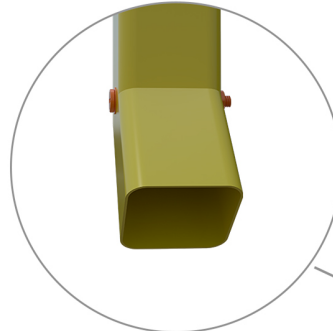
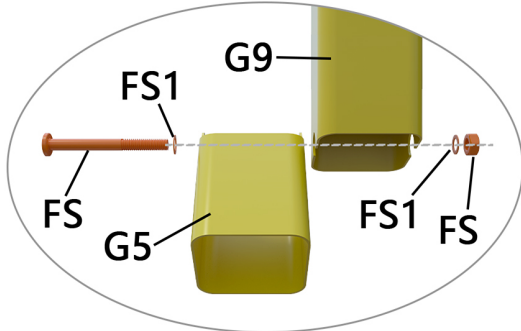

F1 x12



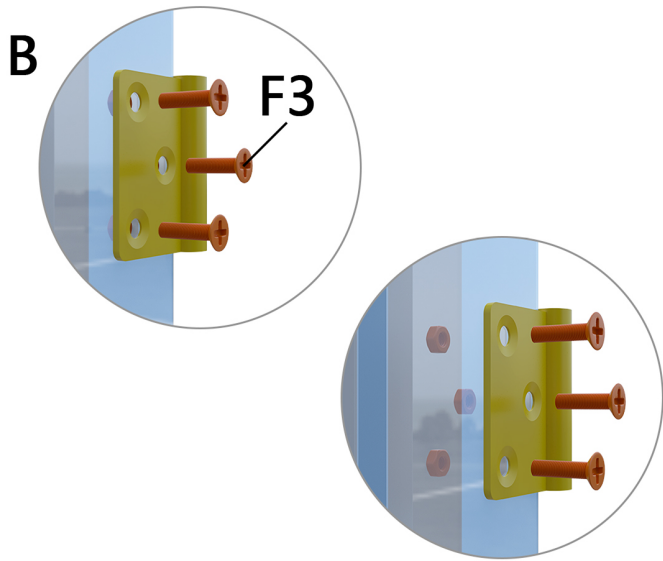
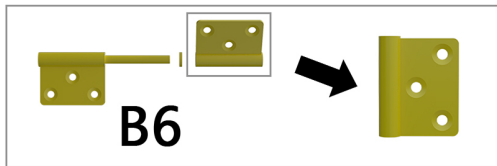
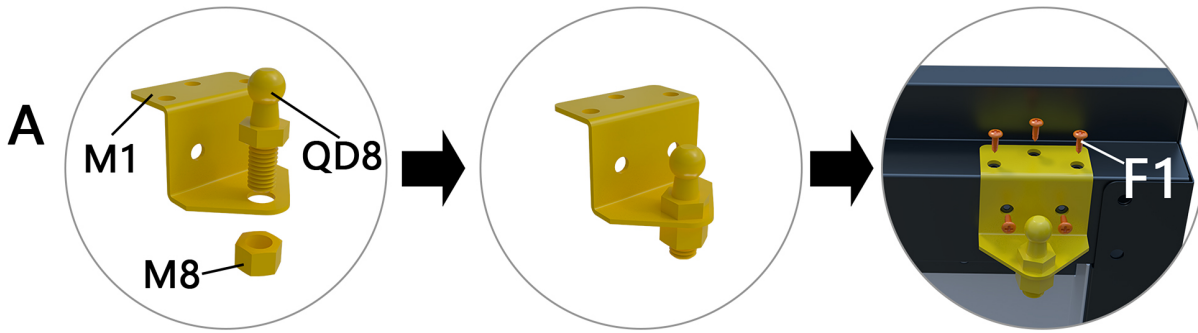

19		D2 x1		M1 x1		QD8 x1			
		B6 x2				M8 x1			F1 x5



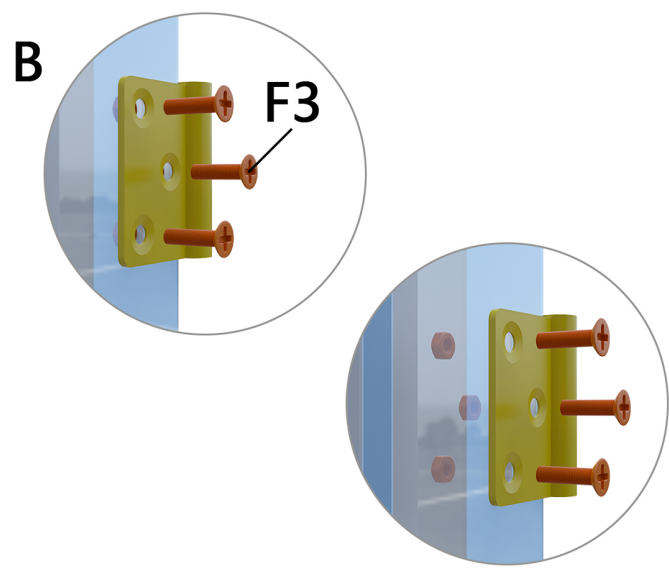
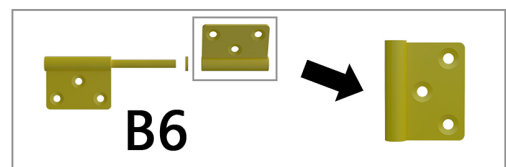
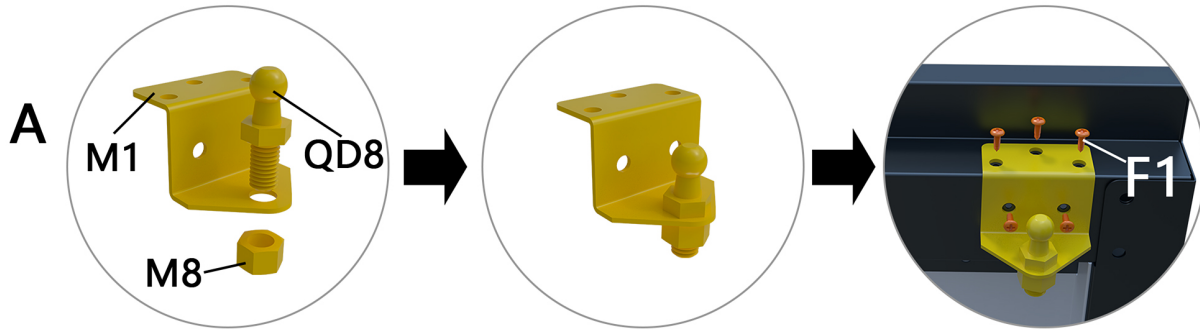





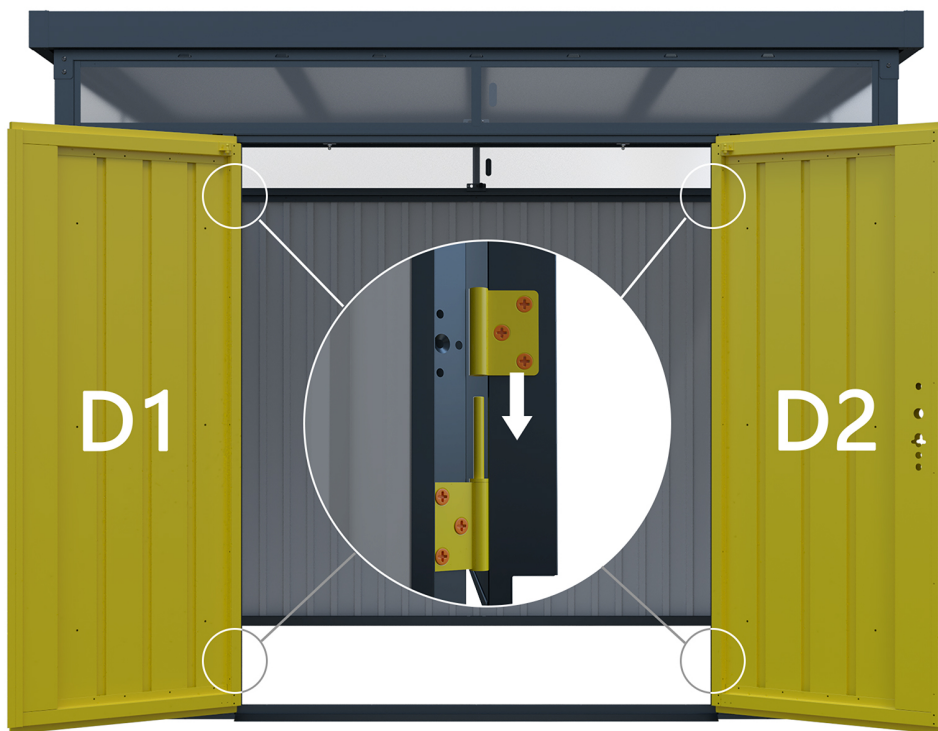
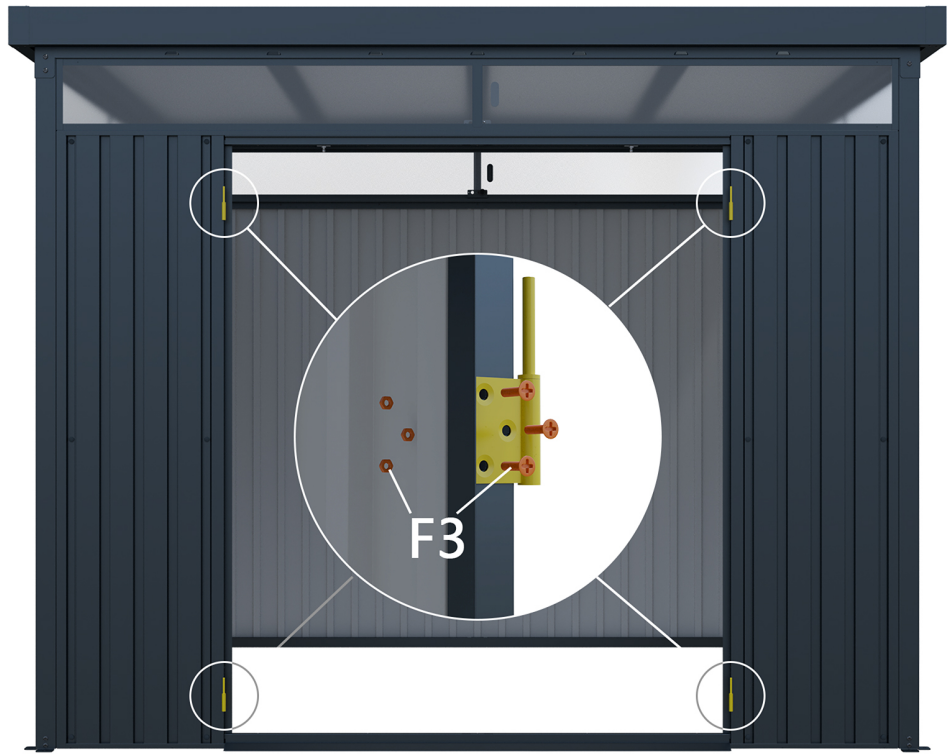
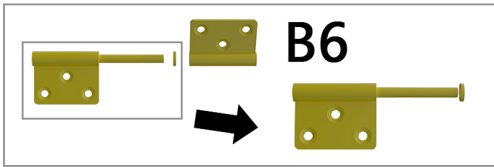

20		D1 x1		M1 x1		QD8 x1			
		B6 x2				M8 x1			F1 x5

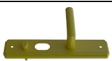

21		B6 x4		F3 x12			

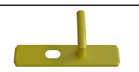
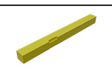

22

 BD x2	 BN x1	 HZ1 x1	 FG1 x2	 FG3 x2	 YS x1
 BW x1	 FG x1	 HZ2 x1	 FG2 x2	 SX x1	 SX1 x1

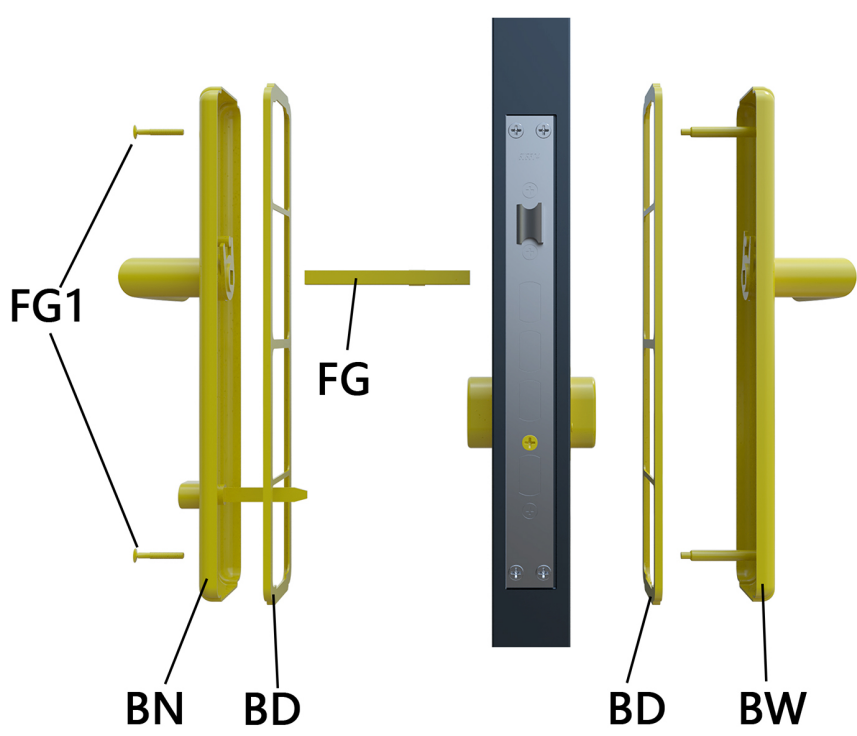
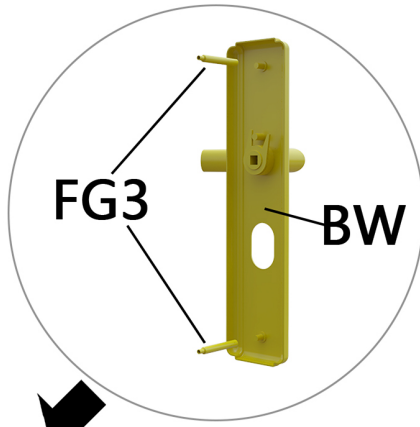
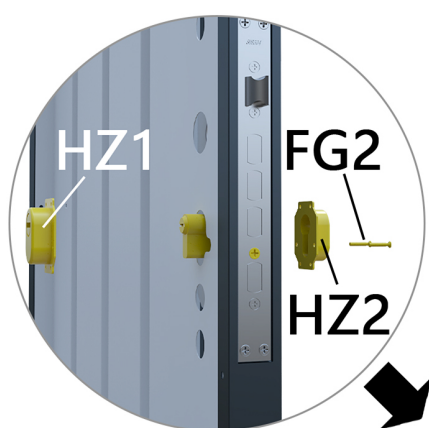

23



G3 x2

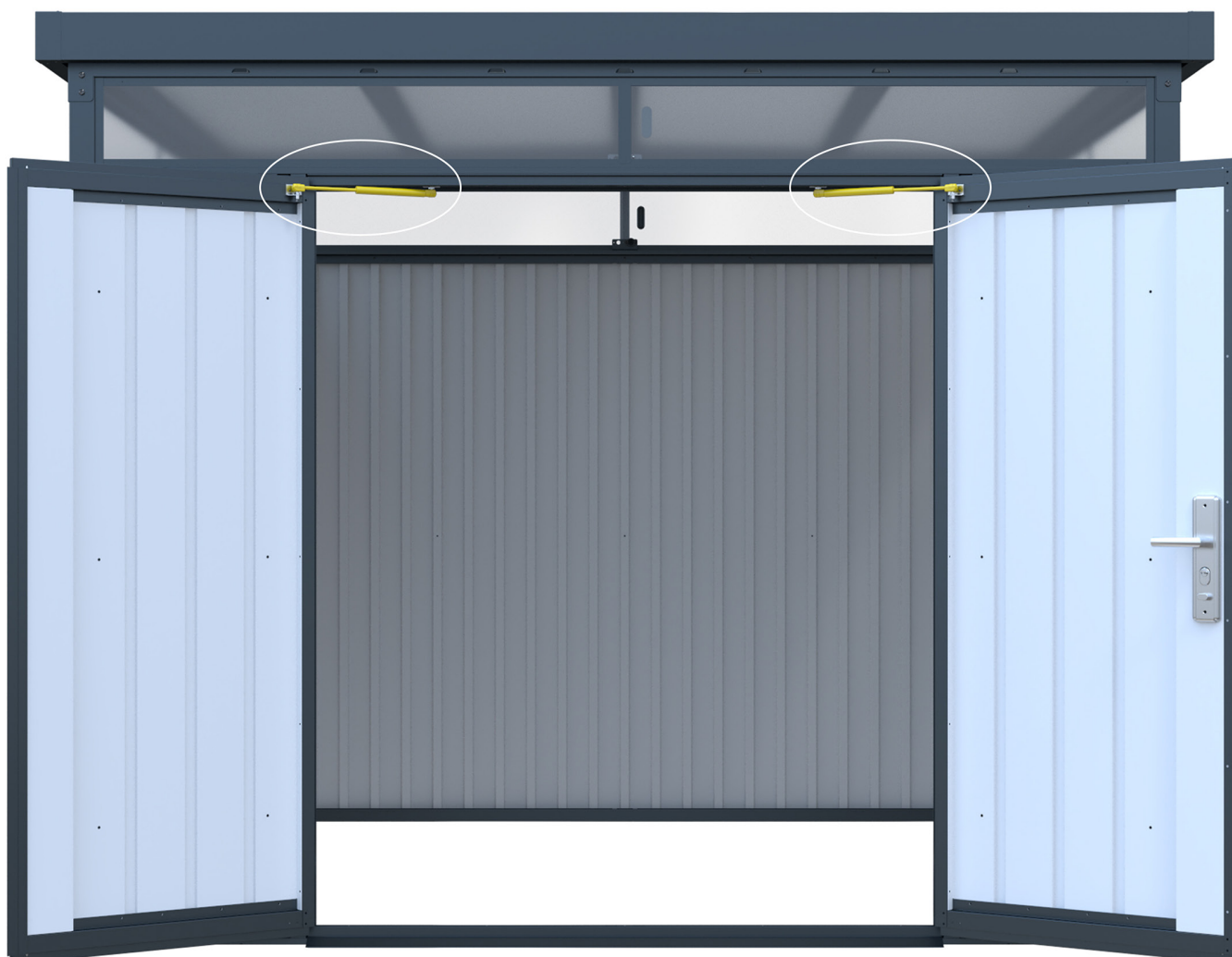
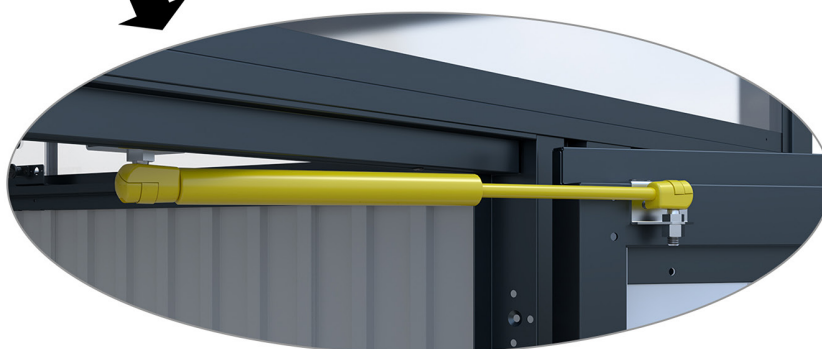
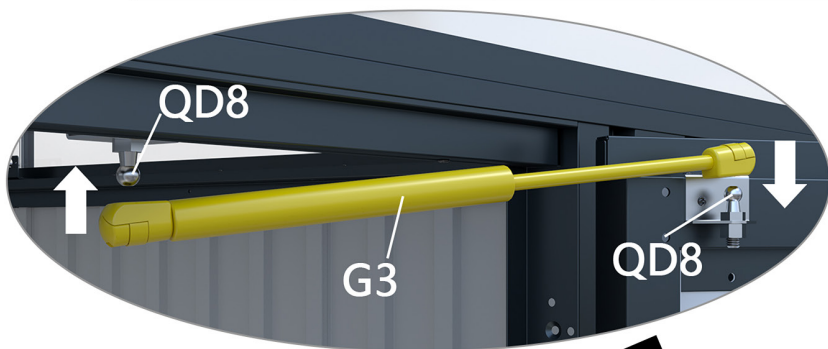

24



S2

