

DE Aufbauanleitung „HakenSet“

- ⓐ Assembly manual for "Hook-Set"
- ⓑ Notice de montage du "Jeu de crochets"
- ⓓ Opbouwbeschrijving voor "Hakenzet"
- ⓔ Instrucciones de montaje de "Set de ganchos"
- ⓖ Istruzioni di montaggio "Set di ganci"
- ⓓk Monteringsvejledning for "Krogsæt"

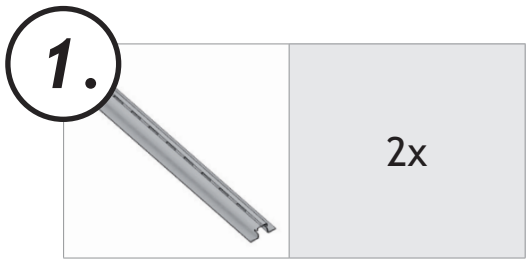



nicht im Lieferumfang - Grundausrüstung

- Ⓒ not included in delivery - standard equipment
- Ⓕ non inclus - equipment de base
- Ⓖ niet inbegrepen - basis uitrusting
- Ⓔ no incluidos en el suministro - equipo básico
- Ⓗ non forniti in dotazione - dotazione di base
- Ⓓ følger ikke med - standardudstyr

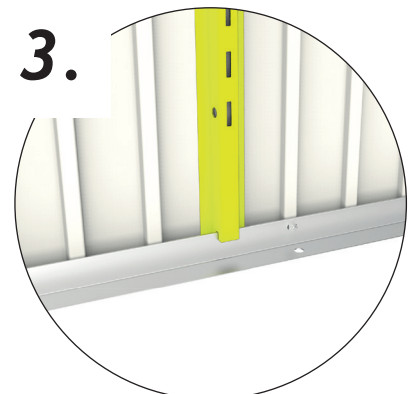
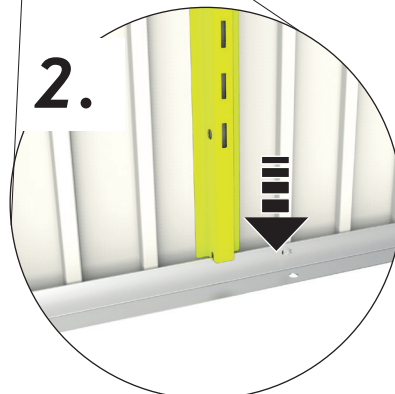
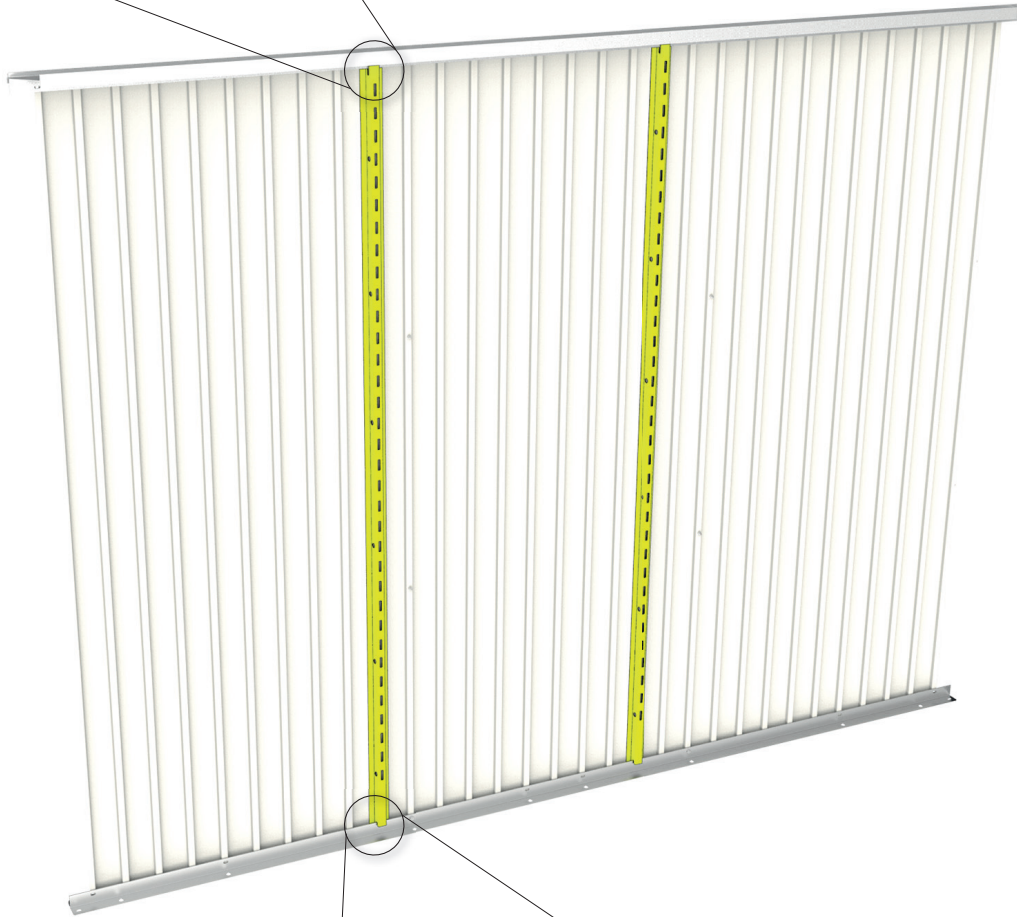
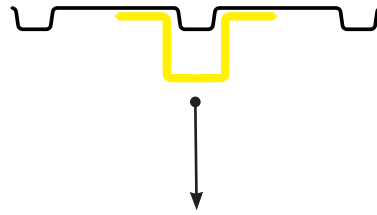
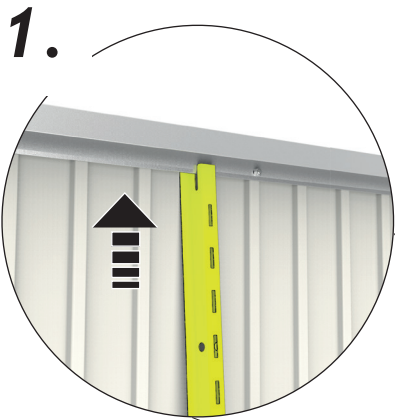

2.

	1x		2x		1x
	1x		1x	M5 x 18 	3x

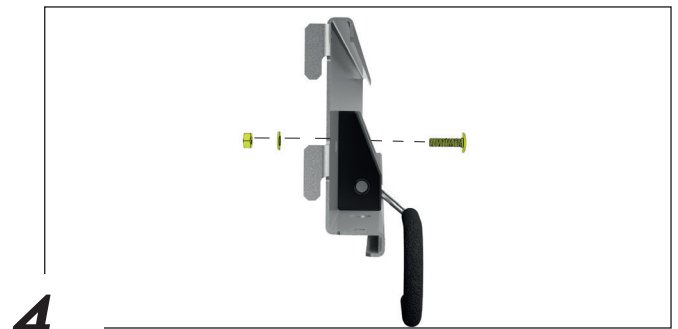
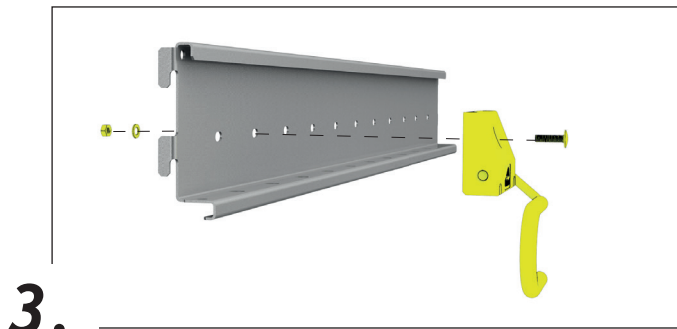
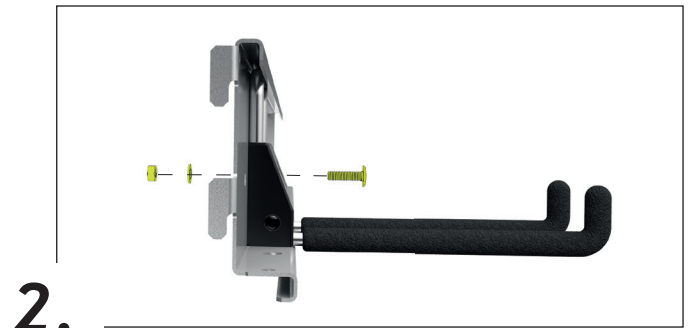
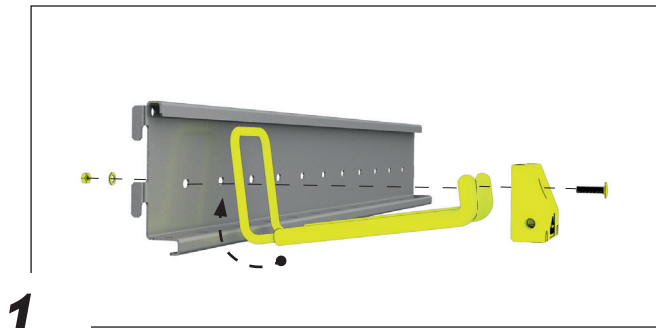

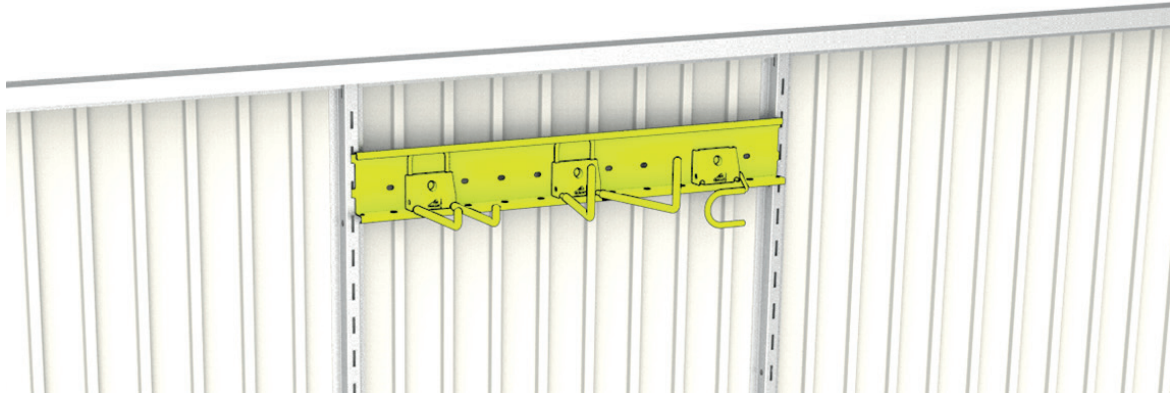

1.

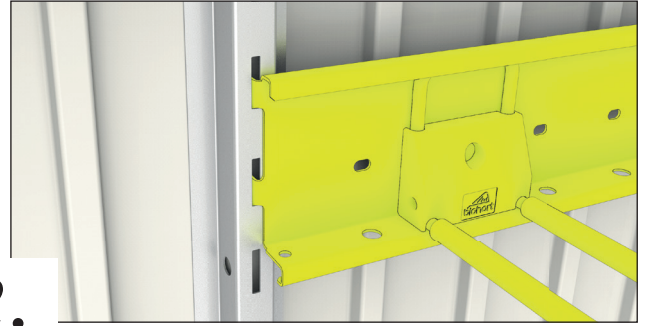

2.

3.



1.



2.

Y1047070
Version 01 / 2018

Kontrollnummer:
Control-number / Contrôle-Qualité / Controlnummer:

Bei Reklamationen bitte anführen:
Kontrollnummer und Artikelnummer des reklamierten Teils.

GB: In case of complaint please indicate the control-number and the number of the item, which is subject of complaint.

F: Pour toutes réclamations: prière de joindre le numéro de contrôle et le numéro d'article de la pièce litigieuse.

NL: Bij reclamaties svp doorgeven: controlnummer en artikelnummer van het desbetreffende onderdeel.



Biohort GmbH
Pürnstein 43, 4120 Neufelden, Österreich
Tel.: +43-7282-7788-0, Fax-DW: 190
E-Mail: office@biohort.at, www.biohort.com