



## ARTWORK

Master Ref: **PHL449172**  
 TR Ref: **TR2052565**  
 Brand: PHILIPS  
 Brand execution: HUE White  
 Product name:  
 Article Number: 50631/\*\*/P7 / 50632/\*\*/P7  
 Region: Trident UK  
 Template Ref: As Previous  
 Artwork 12NC: 440402911482  
 Die cut 12NC:  
 Barcode: N/A  
 CRC Number:  
 Action: **E**  
 Date: 01/02/2021

Project Manager: Arno van den Biggelaar

Trident Artist: Oli Hayton

Technical & Non Printing Items

 Dieline  Guides

Colours:

Black	1
	2

# PHILIPS



TRIDENT  
 Trident UK, Connaught House, Connaught Road,  
 Kingswood Business Park, Hull, HU7 3AP, England.  
 T: +44 (0) 01482 828100

Please note that any low resolution paper Canon colour copies associated with this job should be referred to for content, layout and colour separation only.

UNDER NO CIRCUMSTANCES SHOULD THIS ARTWORK BE ALTERED WITHOUT PRIOR PERMISSION FROM TRIDENT.

# ARTWORK

Master Ref: **PHL449172**  
 TR Ref: **TR2052565**  
 Brand: PHILIPS  
 Brand execution: HUE White  
 Product name:  
 Article Number: 50631/\*\*/P7 / 50632/\*\*/P7  
 Region: Trident UK  
 Template Ref: As Previous  
 Artwork 12NC: 440402911482  
 Die cut 12NC:  
 Barcode: N/A  
 CRC Number:  
 Action: **E**  
 Date: 01/02/2021

Project Manager: Arno van den Biggelaar

Trident Artist: Oli Hayton

Technical & Non Printing Items

■ Dieline ■ Guides

Colours:



# PHILIPS



Trident UK, Connaught House, Connaught Road,  
 Kingswood Business Park, Hull, HU7 3AP, England.  
 T: +44 (0) 01482 828100

Please note that any low resolution paper Canon colour  
 copies associated with this job should be referred to for  
 content, layout and colour separation only.

UNDER NO CIRCUMSTANCES SHOULD THIS  
 ARTWORK BE ALTERED WITHOUT PRIOR  
 PERMISSION FROM TRIDENT.

100 mm

120 mm

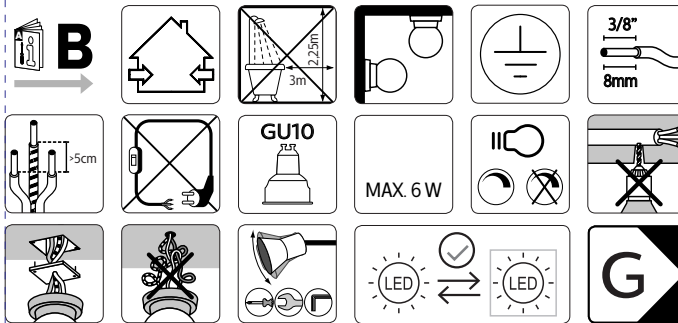
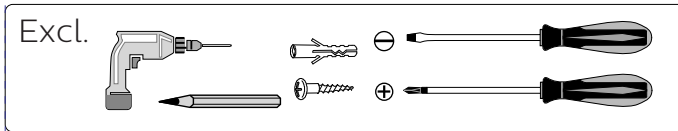
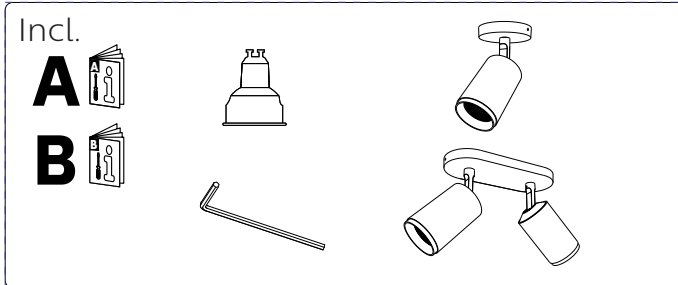

2

# ARTWORK

Master Ref: **PHL449172**  
TR Ref: **TR2052565**  
Brand: PHILIPS  
Brand execution: HUE White  
Product name:  
Article Number: 50631/\*\*/P7 / 50632/\*\*/P7  
Region: Trident UK  
Template Ref: As Previous  
Artwork 12NC: 440402911482  
Die cut 12NC:  
Barcode: N/A  
CRC Number:  
Action: **E**  
Date: 01/02/2021

Project Manager: Arno van den Biggelaar

Trident Artist: Oli Hayton

Technical & Non Printing Items

■ Dieline ■ Guides

Colours:

Black	1
	100%

# PHILIPS



Trident UK, Connaught House, Connaught Road,  
Kingswood Business Park, Hull, HU7 3AP, England.  
T: +44 (0) 01482 828100

Please note that any low resolution paper Canon colour  
copies associated with this job should be referred to for  
content, layout and colour separation only.

UNDER NO CIRCUMSTANCES SHOULD THIS  
ARTWORK BE ALTERED WITHOUT PRIOR  
PERMISSION FROM TRIDENT.

100 mm

120 mm

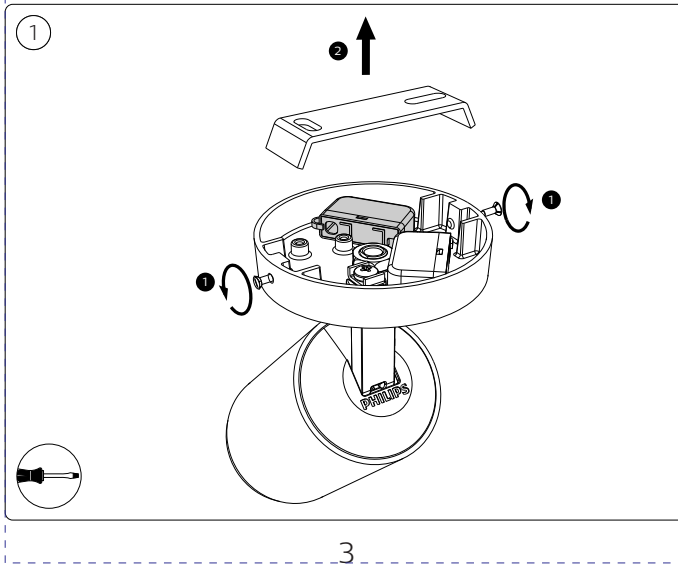
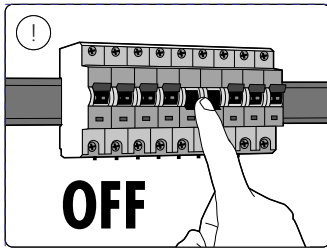

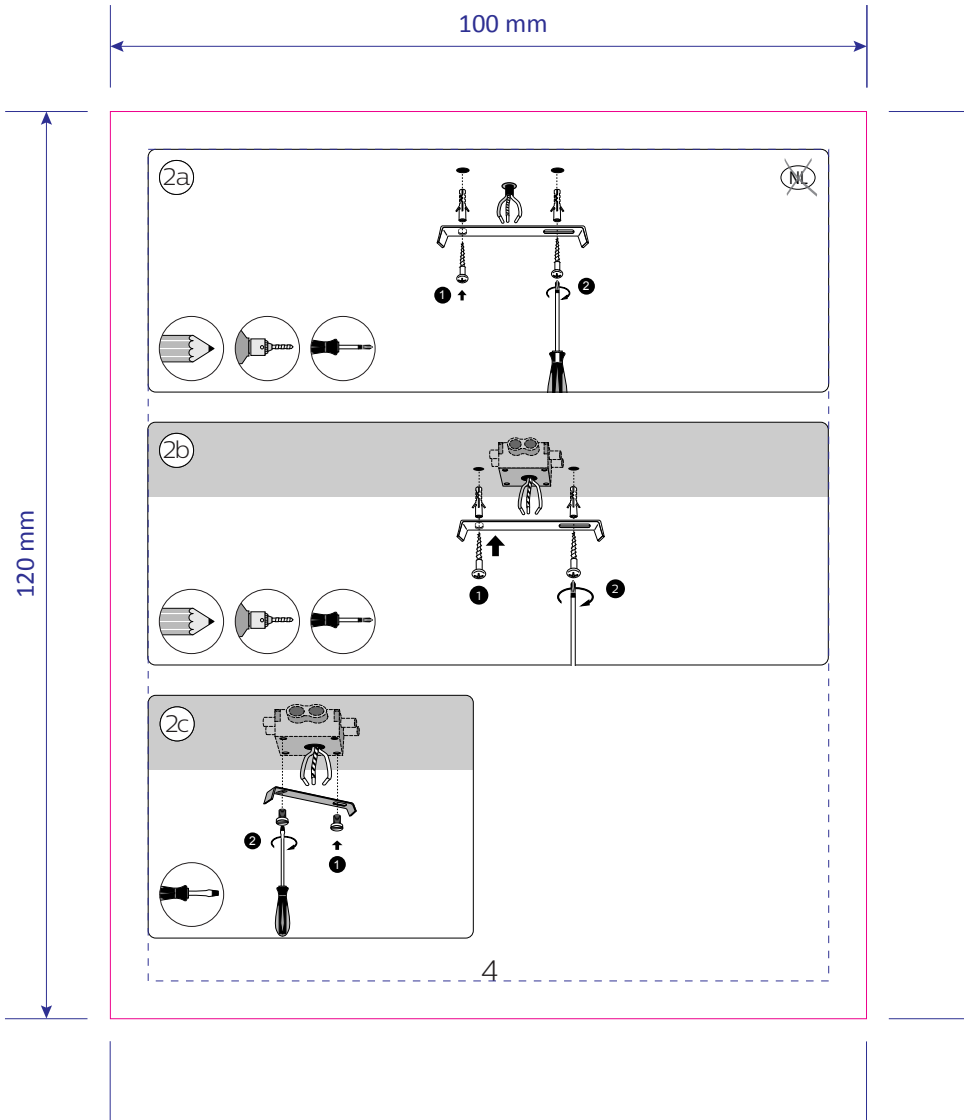

## ARTWORK

Master Ref: **PHL449172**  
 TR Ref: **TR2052565**  
 Brand: PHILIPS  
 Brand execution: HUE White  
 Product name:  
 Article Number: 50631/\*\*/P7 / 50632/\*\*/P7  
 Region: Trident UK  
 Template Ref: As Previous  
 Artwork 12NC: 440402911482  
 Die cut 12NC:  
 Barcode: N/A  
 CRC Number:  
 Action: **E**  
 Date: 01/02/2021

Project Manager: Arno van den Biggelaar

Trident Artist: Oli Hayton

Technical & Non Printing Items

■ Dieline ■ Guides

Colours:

Black	1
	2%

# PHILIPS



Trident UK, Connaught House, Connaught Road,  
 Kingswood Business Park, Hull, HU7 3AP, England.  
 T: +44 (0) 01482 828100

Please note that any low resolution paper Canon colour  
 copies associated with this job should be referred to for  
 content, layout and colour separation only.

UNDER NO CIRCUMSTANCES SHOULD THIS  
 ARTWORK BE ALTERED WITHOUT PRIOR  
 PERMISSION FROM TRIDENT.

# ARTWORK

Master Ref: **PHL449172**  
TR Ref: **TR2052565**  
Brand: PHILIPS  
Brand execution: HUE White  
Product name:  
Article Number: 50631/\*\*/P7 / 50632/\*\*/P7  
Region: Trident UK  
Template Ref: As Previous  
Artwork 12NC: 440402911482  
Die cut 12NC:  
Barcode: N/A  
CRC Number:  
Action: **E**  
Date: 01/02/2021

Project Manager: Arno van den Biggelaar

Trident Artist: Oli Hayton

Technical & Non Printing Items

■ Dieline ■ Guides

Colours:



# PHILIPS



TRIDENT

Trident UK, Connaught House, Connaught Road,  
Kingswood Business Park, Hull, HU7 3AP, England.  
T: +44 (0) 01482 828100

Please note that any low resolution paper Canon colour  
copies associated with this job should be referred to for  
content, layout and colour separation only.

UNDER NO CIRCUMSTANCES SHOULD THIS  
ARTWORK BE ALTERED WITHOUT PRIOR  
PERMISSION FROM TRIDENT.

100 mm

120 mm

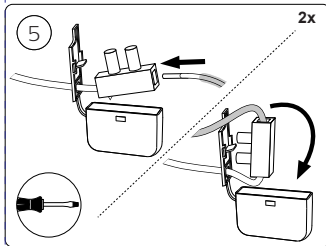
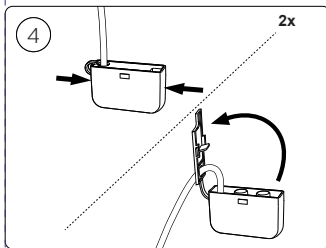
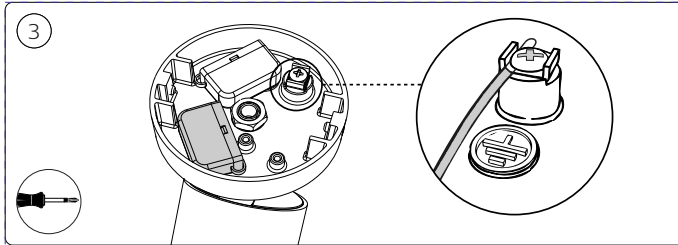

5

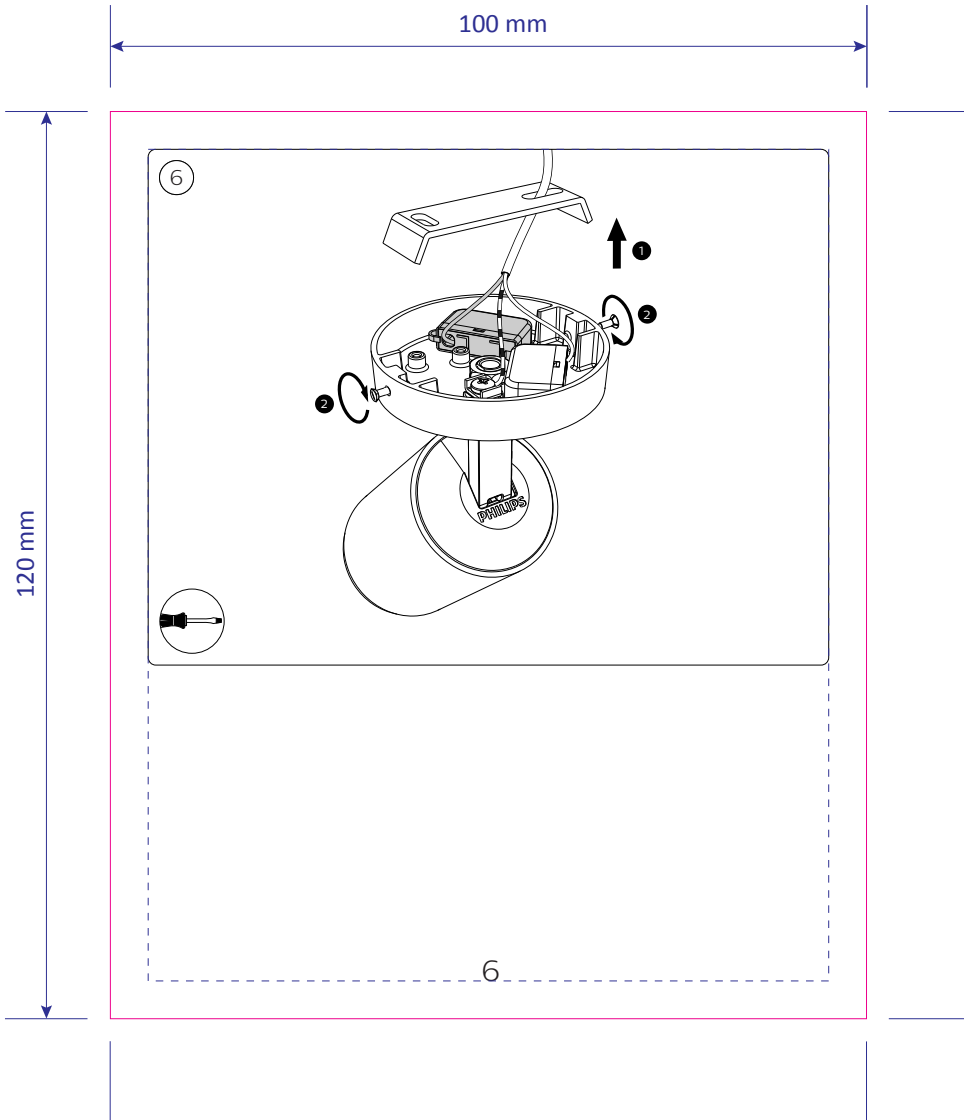

## ARTWORK

Master Ref: **PHL449172**  
 TR Ref: **TR2052565**  
 Brand: PHILIPS  
 Brand execution: HUE White  
 Product name:  
 Article Number: 50631/\*\*/P7 / 50632/\*\*/P7  
 Region: Trident UK  
 Template Ref: As Previous  
 Artwork 12NC: 440402911482  
 Die cut 12NC:  
 Barcode: N/A  
 CRC Number:  
 Action: **E**  
 Date: 01/02/2021

Project Manager: Arno van den Biggelaar

Trident Artist: Oli Hayton

Technical & Non Printing Items

■ Dieline ■ Guides

Colours:

Black	1
	2

# PHILIPS



Trident UK, Connaught House, Connaught Road,  
 Kingswood Business Park, Hull, HU7 3AP, England.  
 T: +44 (0) 01482 828100

Please note that any low resolution paper Canon colour  
 copies associated with this job should be referred to for  
 content, layout and colour separation only.

UNDER NO CIRCUMSTANCES SHOULD THIS  
 ARTWORK BE ALTERED WITHOUT PRIOR  
 PERMISSION FROM TRIDENT.

# ARTWORK

Master Ref: **PHL449172**  
TR Ref: **TR2052565**  
Brand: PHILIPS  
Brand execution: HUE White  
Product name:  
Article Number: 50631/\*\*/P7 / 50632/\*\*/P7  
Region: Trident UK  
Template Ref: As Previous  
Artwork 12NC: 440402911482  
Die cut 12NC:  
Barcode: N/A  
CRC Number:  
Action: **E**  
Date: 01/02/2021

Project Manager: Arno van den Biggelaar

Trident Artist: Oli Hayton

Technical & Non Printing Items

■ Dieline ■ Guides

Colours:

Black	1
	2/3

# PHILIPS



TRIDENT

Trident UK, Connaught House, Connaught Road,  
Kingswood Business Park, Hull, HU7 3AP, England.  
T: +44 (0) 01482 828100

Please note that any low resolution paper Canon colour  
copies associated with this job should be referred to for  
content, layout and colour separation only.

UNDER NO CIRCUMSTANCES SHOULD THIS  
ARTWORK BE ALTERED WITHOUT PRIOR  
PERMISSION FROM TRIDENT.

100 mm

120 mm

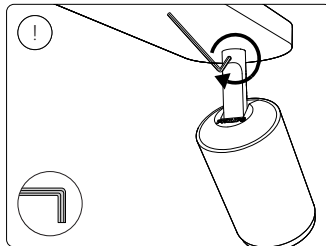
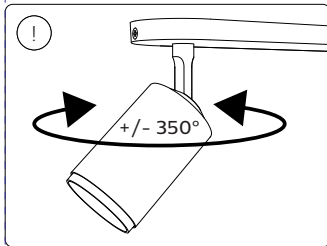
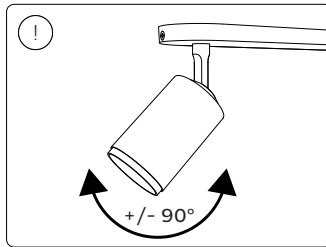
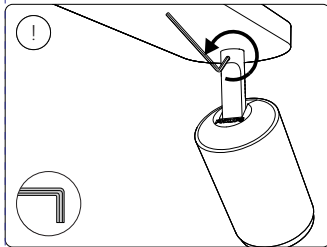
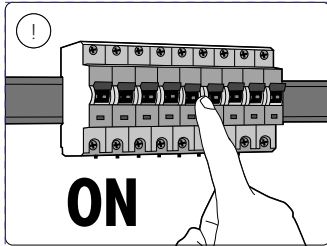

7

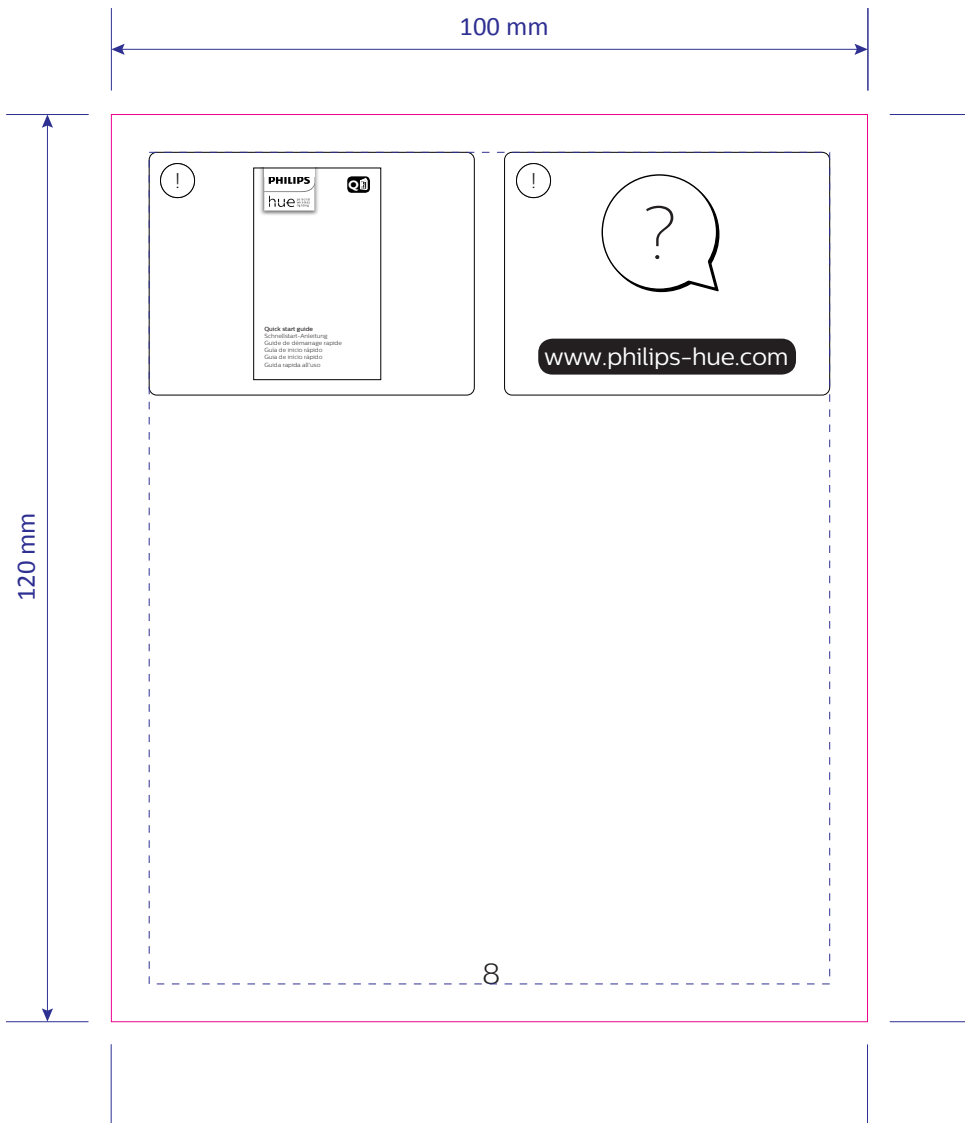

## ARTWORK

Master Ref: **PHL449172**  
 TR Ref: **TR2052565**  
 Brand: PHILIPS  
 Brand execution: HUE White  
 Product name:  
 Article Number: 50631/\*\*/P7 / 50632/\*\*/P7  
 Region: Trident UK  
 Template Ref: As Previous  
 Artwork 12NC: 440402911482  
 Die cut 12NC:  
 Barcode: N/A  
 CRC Number:  
 Action: **E**  
 Date: 01/02/2021

Project Manager: Arno van den Biggelaar

Trident Artist: Oli Hayton

Technical & Non Printing Items

■ Dieline
 ■ Guides

Colours:



# PHILIPS



TRIDENT

Trident UK, Connaught House, Connaught Road,  
 Kingswood Business Park, Hull, HU7 3AP, England.  
 T: +44 (0) 01482 828100

Please note that any low resolution paper Canon colour copies associated with this job should be referred to for content, layout and colour separation only.

UNDER NO CIRCUMSTANCES SHOULD THIS  
 ARTWORK BE ALTERED WITHOUT PRIOR  
 PERMISSION FROM TRIDENT.



# ARTWORK

Master Ref: **PHL449172**  
TR Ref: **TR2052565**  
Brand: PHILIPS  
Brand execution: HUE White  
Product name:  
Article Number: 50631/\*\*/P7 / 50632/\*\*/P7  
Region: Trident UK  
Template Ref: As Previous  
Artwork 12NC: 440402911482  
Die cut 12NC:  
Barcode: N/A  
CRC Number:  
Action: **E**  
Date: 01/02/2021

Project Manager: Arno van den Biggelaar

Trident Artist: Oli Hayton

Technical & Non Printing Items

■ Dieline ■ Guides

Colours:



# PHILIPS



TRIDENT

Trident UK, Connaught House, Connaught Road,  
Kingswood Business Park, Hull, HU7 3AP, England.  
T: +44 (0) 01482 828100

Please note that any low resolution paper Canon colour  
copies associated with this job should be referred to for  
content, layout and colour separation only.

UNDER NO CIRCUMSTANCES SHOULD THIS  
ARTWORK BE ALTERED WITHOUT PRIOR  
PERMISSION FROM TRIDENT.

100 mm

120 mm

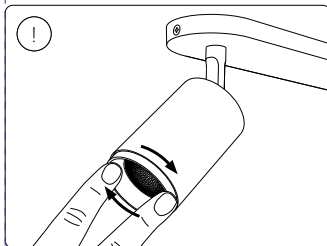
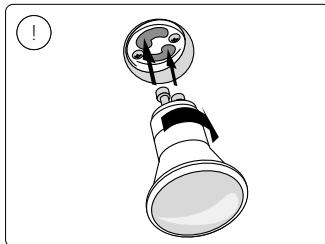
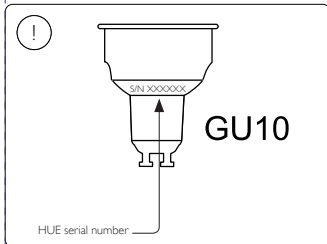
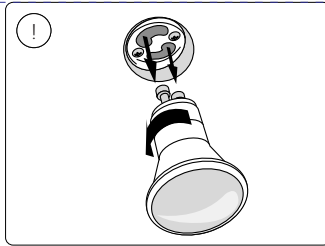
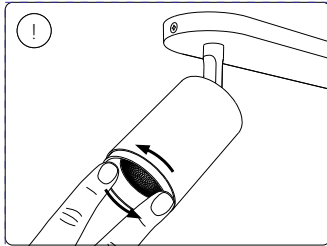

9

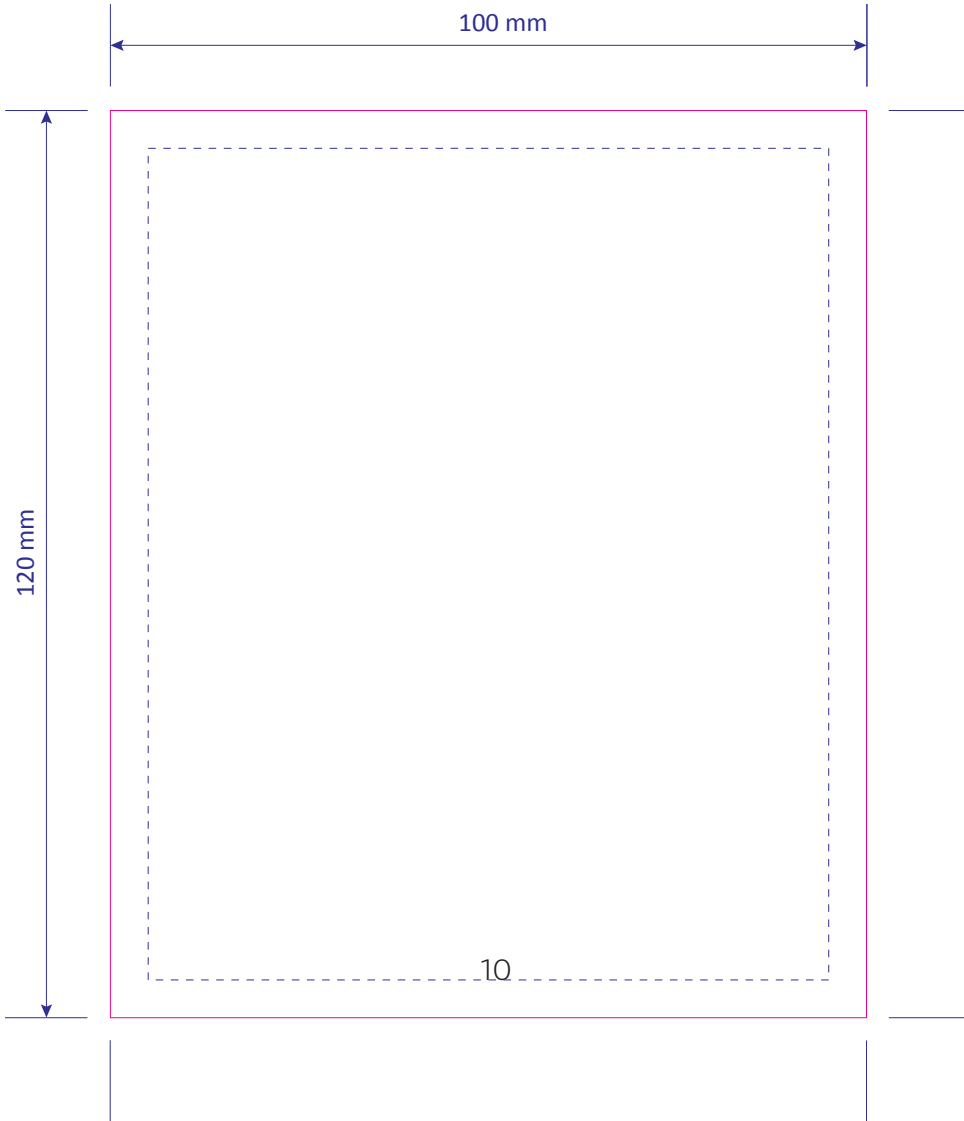

## ARTWORK

Master Ref: **PHL449172**  
 TR Ref: **TR2052565**  
 Brand: PHILIPS  
 Brand execution: HUE White  
 Product name:  
 Article Number: 50631/\*\*/P7 / 50632/\*\*/P7  
 Region: Trident UK  
 Template Ref: As Previous  
 Artwork 12NC: 440402911482  
 Die cut 12NC:  
 Barcode: N/A  
 CRC Number:  
 Action: **E**  
 Date: 01/02/2021

Project Manager: Arno van den Biggelaar

Trident Artist: Oli Hayton

Technical & Non Printing Items

■ Dieline    ■ Guides

Colours:



# PHILIPS



TRIDENT

Trident UK, Connaught House, Connaught Road,  
 Kingswood Business Park, Hull, HU7 3AP, England.  
 T: +44 (0) 01482 828100

Please note that any low resolution paper Canon colour copies associated with this job should be referred to for content, layout and colour separation only.

UNDER NO CIRCUMSTANCES SHOULD THIS  
 ARTWORK BE ALTERED WITHOUT PRIOR  
 PERMISSION FROM TRIDENT.

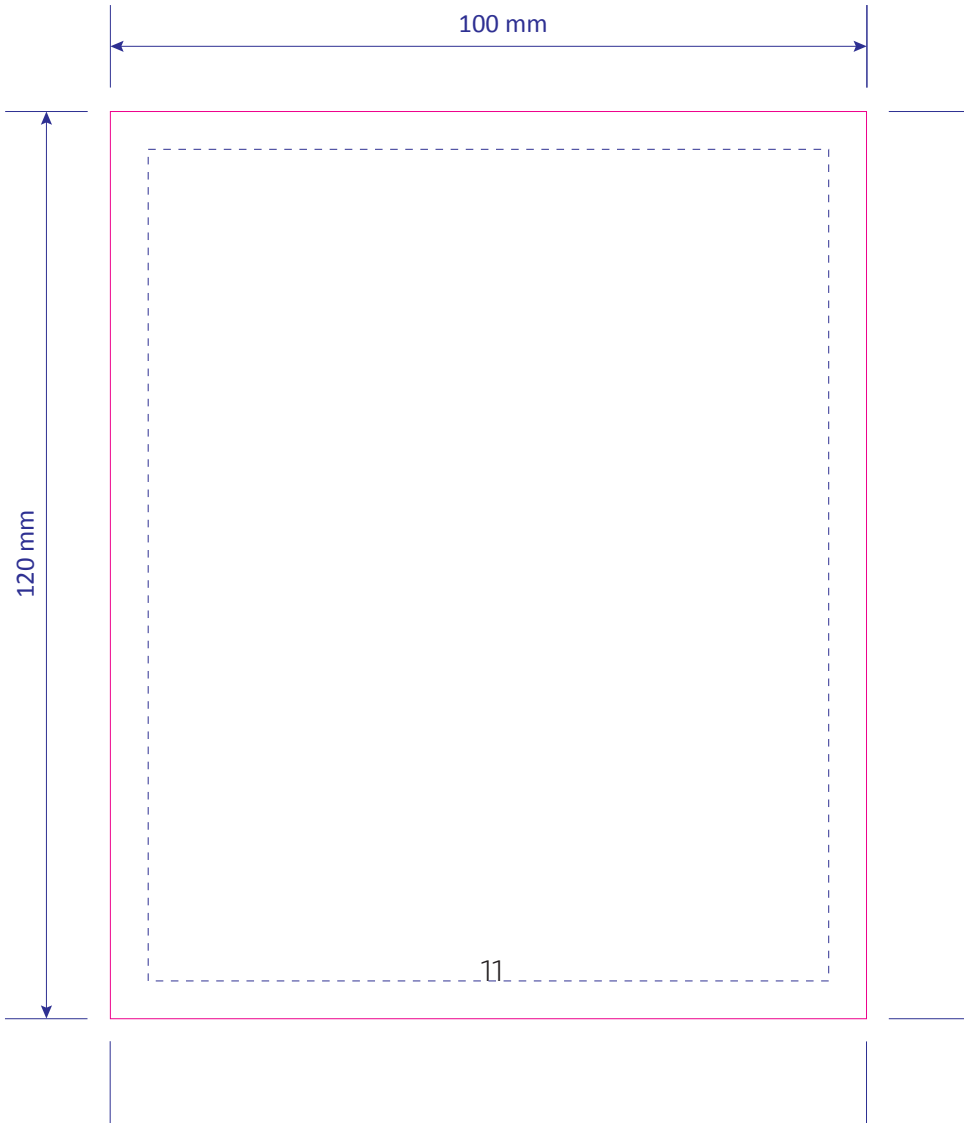

# ARTWORK

Master Ref: **PHL449172**  
TR Ref: **TR2052565**  
Brand: PHILIPS  
Brand execution: HUE White  
Product name:  
Article Number: 50631/\*\*/P7 / 50632/\*\*/P7  
Region: Trident UK  
Template Ref: As Previous  
Artwork 12NC: 440402911482  
Die cut 12NC:  
Barcode: N/A  
CRC Number:  
Action: **E**  
Date: 01/02/2021

Project Manager: Arno van den Biggelaar

Trident Artist: Oli Hayton

Technical & Non Printing Items  
■ Dieline ■ Guides

Colours:

Black	1
	3%

# PHILIPS



**TRIDENT**  
Trident UK, Connaught House, Connaught Road,  
Kingswood Business Park, Hull, HU7 3AP, England.  
T: +44 (0) 01482 828100

Please note that any low resolution paper Canon colour copies associated with this job should be referred to for content, layout and colour separation only.

UNDER NO CIRCUMSTANCES SHOULD THIS ARTWORK BE ALTERED WITHOUT PRIOR PERMISSION FROM TRIDENT.

## ARTWORK

Master Ref: **PHL449172**  
TR Ref: **TR2052565**  
Brand: PHILIPS  
Brand execution: HUE White  
Product name:  
Article Number: 50631/\*\*/P7 / 50632/\*\*/P7  
Region: Trident UK  
Template Ref: As Previous  
Artwork Ref: 440402911482  
Die cut 12NC:  
Barcode: N/A  
CRC Number:  
Action: **E**  
Date: 01/02/2021

Project Manager: Arno van den Biggelaar

Trident Artist: Oli Hayton

Technical & Non Printing Items

 Dieline  Guides

Colours:



# PHILIPS



TRIDENT

Trident UK, Connaught House, Connaught Road,  
Kingswood Business Park, Hull, HU7 3AP, England.  
T: +44 (0) 01482 828100

Please note that any low resolution paper Canon colour  
copies associated with this job should be referred to for  
content, layout and colour separation only.

UNDER NO CIRCUMSTANCES SHOULD THIS  
ARTWORK BE ALTERED WITHOUT PRIOR  
PERMISSION FROM TRIDENT.

100 mm

120 mm



Signify  
J.B.R.S. / C.C.R.I. Numéro 10461  
5600 VB Eindhoven,  
the Netherlands  
000800-74454775

Signify Australia Limited  
65 Epping Road, North Ryde,  
NSW, 2113 Australia  
Toll Free number: 1300 304 404

Signify New Zealand Limited  
123 Carlton Gore Road  
Newmarket, Auckland 1023  
New Zealand  
Tel: 0800 454 448

[www.philips-hue.com](http://www.philips-hue.com)

4404 029 11482

Last update: 01/2021

© 2021 Signify Holding  
All rights reserved