

# WelcomeEye Comfort

DES9500VDP - 531019

# WelcomeEye Compact

DES9300VDP - 531004



FR - Notice téléchargeable sur [philips.com](http://philips.com)  
GB - Downloadable instructions at [philips.com](http://philips.com)  
D - Anleitung kann auf [philips.com](http://philips.com) heruntergeladen werden  
NL - De handleiding kan gedownload worden op [philips.com](http://philips.com)  
PL - Instrukcja do pobrania na [philips.com](http://philips.com)  
IT- Il manuale è disponibile anche su [www.philips.com](http://www.philips.com).  
ES - Manual que puede descargar en [philips.com](http://philips.com)  
PT - Manual de instruções disponível no site [philips.com](http://philips.com)

09/2017



Scan me  
to find out about our products

Flashez-moi  
pour découvrir nos produits

# PHILIPS

# TABLE OF CONTENTS

<b>1</b>	<b>SAFETY INSTRUCTIONS</b> .....	p.2
<b>2</b>	<b>CONTENT OF THE KIT</b> .....	p.2
<b>3</b>	<b>GENERAL INFORMATION</b> .....	p.3
<b>4</b>	<b>NOMENCLATURE</b> .....	p.3
<b>5</b>	<b>PRODUCT INSTALLATION</b> .....	p.5
	1. Wiring	
	2. Configuring the intercom	
	3. Installing the main or additional monitor	
	4. Installing the main or additional intercom panel	
	5. Installing a camera (optional)	
<b>6</b>	<b>MONITOR INTERFACE</b> .....	p.8
	A. Monitoring function and response to a call	
	B. Intercom function	
	C. Settings	
<b>7</b>	<b>USER GUIDE</b> .....	p.11
<b>8</b>	<b>TECHNICAL CHARACTERISTICS</b> .....	p.12
<b>9</b>	<b>ACCESSORIES</b> .....	p.13
<b>10</b>	<b>FAQ</b> .....	p.13
<b>11</b>	<b>TECHNICAL ASSISTANCE - WARRANTY</b> .....	p.16
<b>12</b>	<b>SAFETY PRECAUTIONS</b> .....	p.17
<b>13</b>	<b>FCC/CE WARNING</b> .....	p.18
<b>14</b>	<b>DECLARATION OF CONFORMITY</b> .....	p.18



# 1. SAFETY INSTRUCTIONS

## Important!

- Please read the user manual carefully before installing or using this product.
- If you are installing this product for a third party, please remember to leave the manual or a copy of it with the end user.

## Warning:

- The various components may only be dismantled by an authorised technician.

## Safety precautions:

- To ensure the safe operation of the system, installers, users and technicians must follow all the safety procedures described in this manual.
- Specific warnings and warning symbols are marked on the components where necessary.

# 2. CONTENTS OF THE KIT



1. 7" monitor  
(WelcomeEye Comfort)

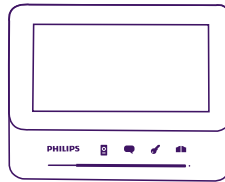

1.b 4.3" screen  
(WelcomeEye Compact)

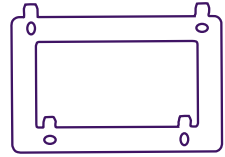

2. Wall bracket

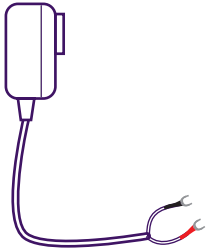

3. Plug-in power supply



4. Adaptor for plug-in power supply compatible with EU or UK plug



5. Intercom panel

### 3. GENERAL

This Video doorphone consists of an indoor answering unit with a touch screen and an outdoor panel with an intercom and camera, allowing you to see and communicate with the visitor who has pressed the bell. It is easy to install as only two wires are needed for all functions: bell, video image, intercom and strike plate and automatic opener controls.

The **WelcomeEye** technology allows you to share the intercom panel between 2 families. Each family can own up to 3 monitors.

The system can operate up to one camera and two intercom panels.

To get the most out of your intercom, please read this instruction manual carefully.

### 4. NOMENCLATURE

Monitor:

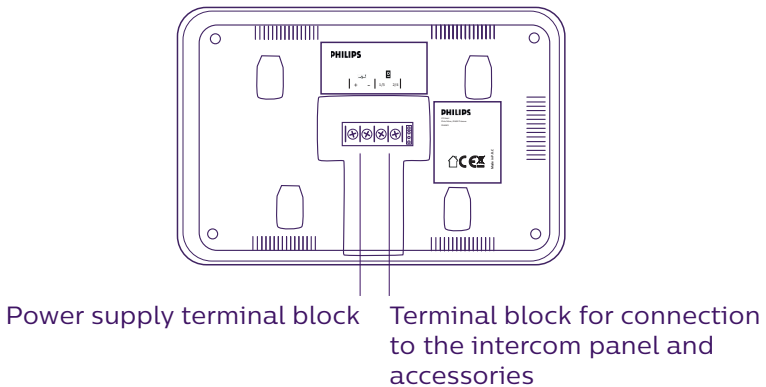
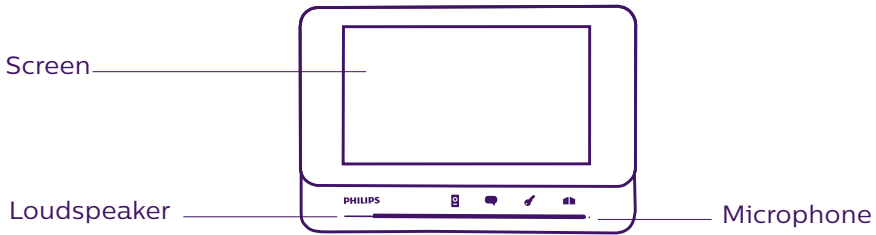

Intercom panel:

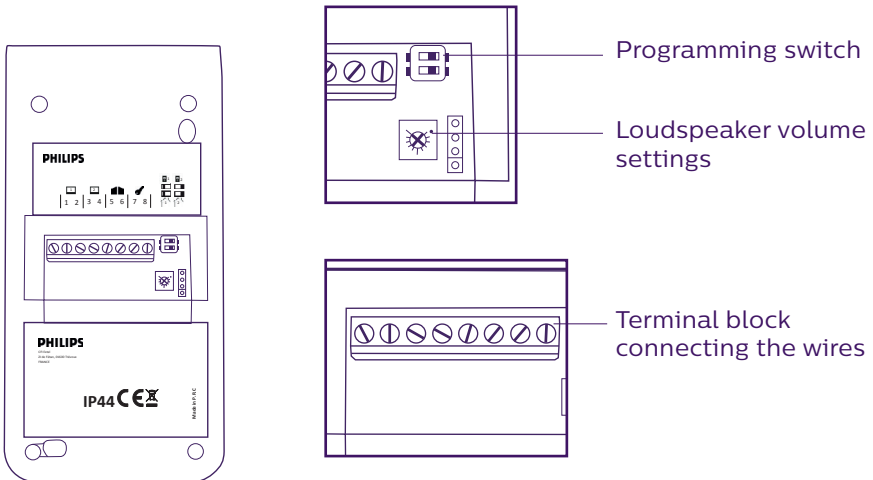
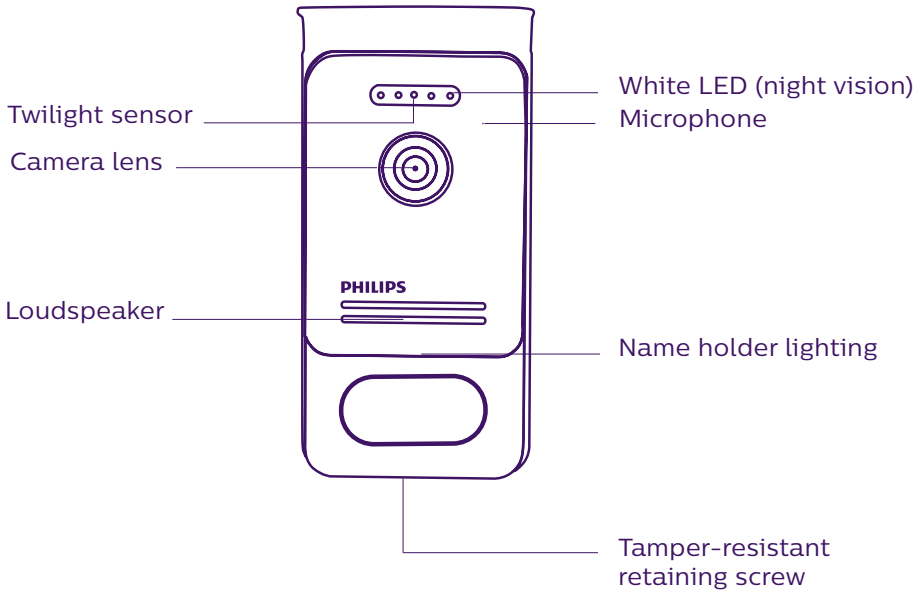

**Notes:**

- When someone presses the call button, the inside monitor rings and the video is displayed.
- To change the nameplate label, remove the front cover and unclip the plastic cap behind the label.

# 5. PRODUCT INSTALLATION

Important notes and advice:

- **To make the most of your intercom panel, we recommend configuring it (for 1 or 2 families, 1 or 2 intercoms, loudspeaker volume) before final installation. To do this, it might be necessary to connect up the system on a table to check that the settings are correct.**
- If you test your product before installing it, ensure that you do not test it with the intercom panel and the monitor in the same room to avoid the Video doorphone emitting a shrill noise (feedback).
- Do not expose the camera lens to direct sunlight or a reflective surface.
- We recommend running the cables through a protective sheath to protect them against breakage and bad weather.

## 1. Wiring

To avoid the risk of interference and malfunctions, do not run the Video doorphone cable through the same sheath as the electrical cables.

**Warning:** Do not double up the wires to increase their section.

### a. Connecting the video doorphone (monitor, intercom panel and camera, see fig. 1, fig. 2 or fig. 3)

Wires to be used: 2 wires 0.75 mm<sup>2</sup> with 80 m length or 2 wires 1.5 mm<sup>2</sup> with 120 m length.

- Make sure to connect the wires in accordance with one of the wiring diagrams depending on the desired configuration.
- Refer to the label stuck to the back of the monitor and the back of the intercom panel.
- **Configure the switches on the back of the intercom panel as well as the monitor interface according to the chosen configuration (see section 2 intercom configuration).**

### b. Connecting a gate motor

- The intercom provides a dry contact (without power) to be connected to the push button control of the automatic opener.
- Connect it directly to terminals 5 and 6 at the back of the intercom panel (no need to observe polarity).
- The opening function is only possible if the video of the respective intercom panel is displayed.

### c. Connecting a strike plate or electric lock

**Important:** The strike plate or electric lock that you are ordering must have a mechanical memory. The strike plate current cannot exceed 1.1A.

- Connect it directly to terminals 7 and 8 at the back of the intercom panel (no need to observe polarity).
- The opening function is only possible if the video of the respective intercom panel is displayed.

## 2. Configuring the intercom (see fig. 1, fig. 2 or fig. 3)

### **a. Configuring the intercom number:**

Place switch 2 on the left on intercom no. 1 and on the right on intercom no. 2.

### **b. Configuring the number of families:**

Place switch 1 on the left to be in one-family mode and on the right to be in 2-family mode.

### **c. Intercom volume settings:**

Turn the volume control with a Phillips head screwdriver to adjust the intercom volume.

## 3. Installing the main or additional monitor

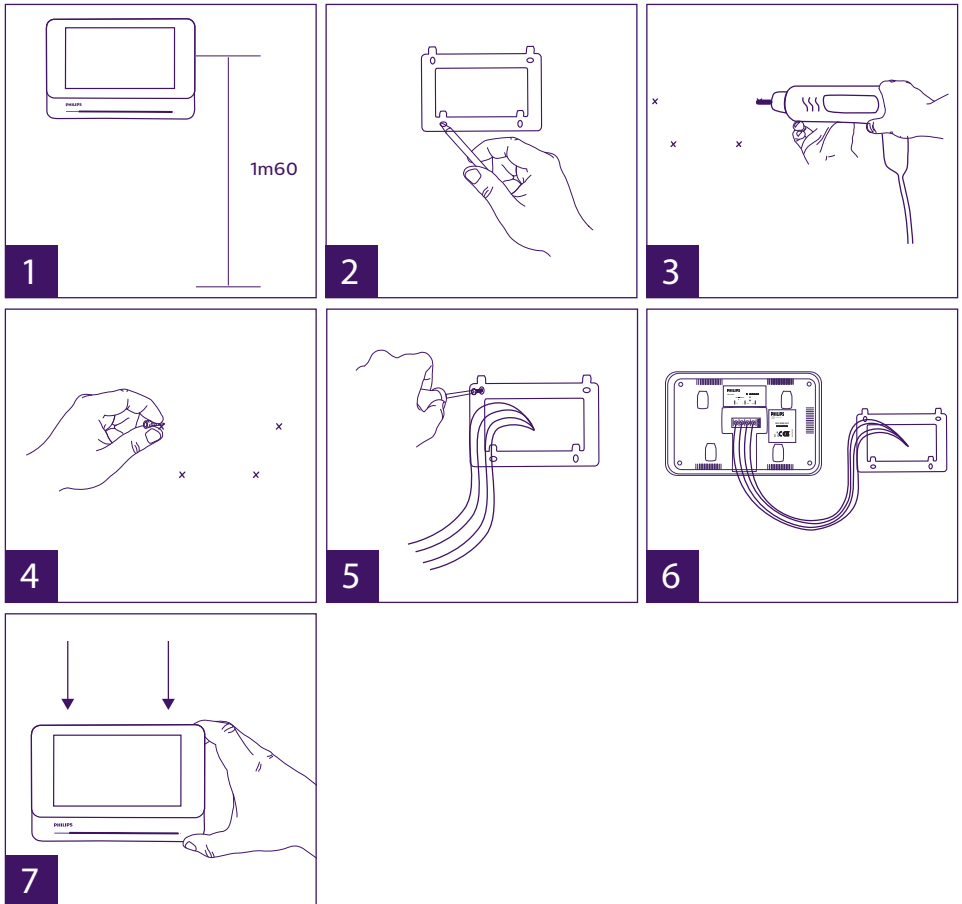

1 - Position the wall bracket so that the screen of the monitor is approximately 1.60m above the ground.

2 - Mark the location of the holes using the U bolt.

3 - Drill.

4 - Use the correct wall plugs for the bracket (those supplied are suitable for solid walls).

5 - Attach the wall bracket.

- 6 - Connect the 2 intercom panel wires and the 2 power supply wires in accordance with the wiring diagram.
- 7 - Position the monitor on the wall bracket.
- 8 - Depending on the configuration selected, and when wiring is completed, the interface may have to be configured.

 **Warning:** during this step, do not connect the power supply to the 230V AC.

#### 4. Installing the main or additional intercom panel

**Warning:** The product must not be connected to the power supply before wiring is complete.

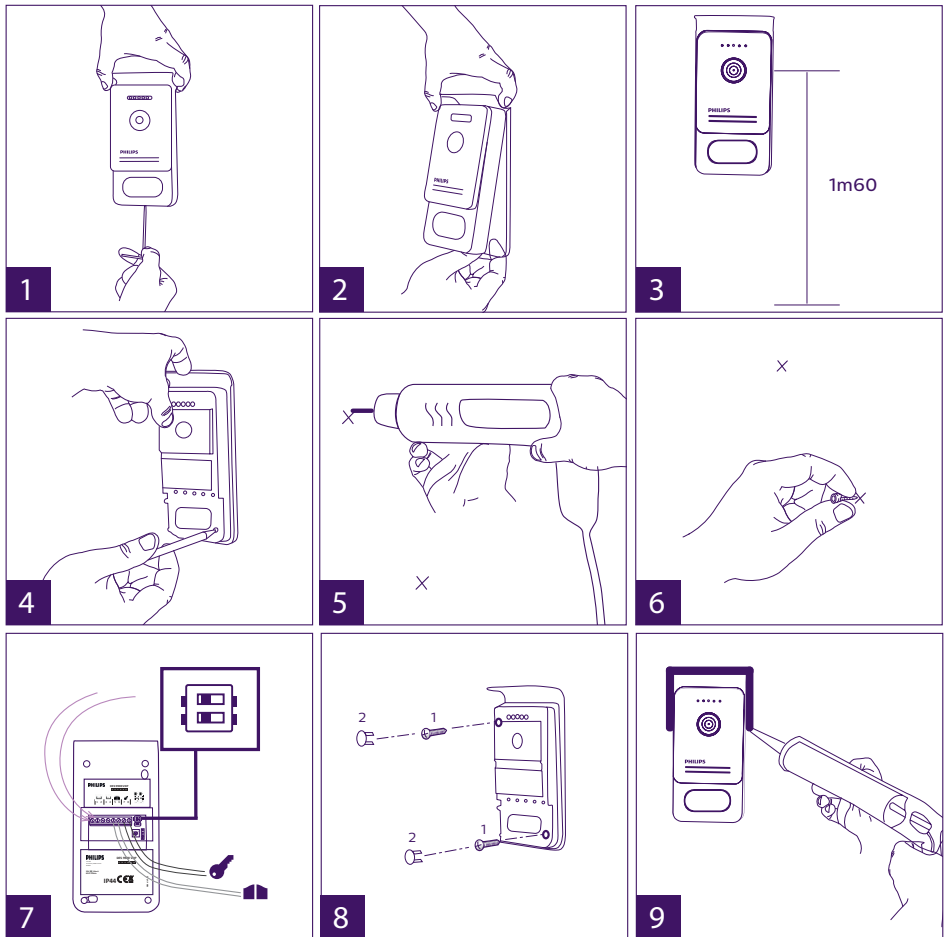

- 1 - Remove the tamper-resistant screw from the intercom panel.
- 2 - Tip the intercom panel cover forward.
- 3 - The intercom's lens should be approximately 1.60m above the ground.
- 4 - Mark the locations.



- 5 - Drill.
- 6 - Use the correct fixings for the mounting surface (the screws provided are suitable for solid walls).
- 7 - Connect the two wires from the monitor and, if necessary, connect the electric strike plate and the gate (see section 1. Wiring). Configure the switches at the back of the intercom panel (see section 2. Configuring the intercom).
- 8 - Insert the screws and refit the two caps concealing the retaining screws.  
**Note:** the screws must be driven through the black grommets on the back of the outdoor station.
- 9 - Refit the front cover of the intercom and tighten the tamper-resistant retaining screw.
- 10 - Connect the 230V AC power supply to the modular adaptor, for an installation compliant with applicable standards (NFC 15-100 in France).
  - Verify the smooth functioning (video call, etc.).
  - When there is a second intercom panel, don't forget to configure the monitor(s).
- 11 - Attach a silicone seal\* between the shield and the wall to stop flowing water. \*Do not use acetic acid-based silicone (vinegar odour).



## 5. Installing a camera (optional)

Connect the wires in accordance with the wiring diagram.

Choose a suitable place to install the camera.

Ensure that nothing gets in the way of the installation.

Screw the wall section with the screws provided (for solid walls).

Point the camera in the desired direction and tighten the retainer screw.

Configure the monitor(s)



**Warning:** no audio

## 6. MONITOR INTERFACE

### Main Menu

Press the button to turn on the screen and access the main menu

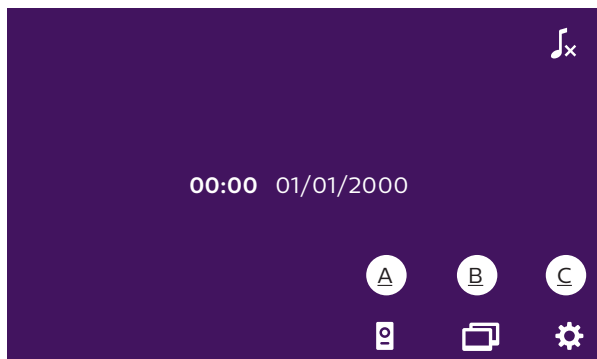

A. Monitoring function and response to a call

B. Intercom function

C. Settings

 : indicates that the monitor ringtone is deactivated

## A. Monitoring function and response to a call

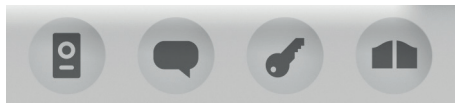

1                      2                      3                      4

- 1: To switch to the view of the second intercom panel or camera, or return to the main menu.
- 2: To establish voice communication with the intercom panel and hang up.
- 3: To open the electric strike plate.
- 4: To open the gate.

## B. Intercom function

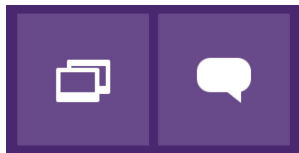

1                      2

Function only valid if an additional monitor is connected and the parameters are set correctly.

- 1: To exit the function
- 2: To call the other monitors in the family, answer calls from another monitor or hang up.

## C. Settings

The settings menu has 2 pages.

Click on  to return to the previous menu.

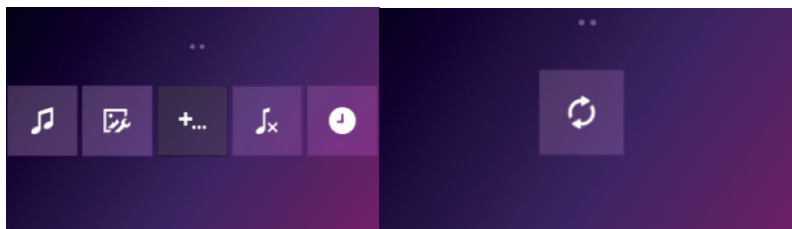

1                      2                      3                      4                      5

6

## 1: Audio settings



- a: Choice of ringtone during a call from intercom panel 1
- b: Choice of ringtone during a call from intercom panel 2 (only if an additional intercom panel has been configured)
- c: Choice of ringtone during an intercom call (only if an additional monitor has been configured)
- d: Volume settings for the monitor ringtone
- e: Volume settings for the monitor loudspeaker during communication.

## 2: Image settings

Image brightness, contrast and colour settings.

## 3: Configuring the WelcomeEye system options

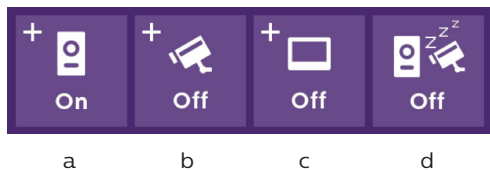

- a: Activation of a second intercom panel (choose **On** if a second intercom panel is used).
- b: Activation of the camera option (choose on if a camera is used).
- c: Configuration of the monitor(s). When the system has several monitors, you must configure one of them as the **Master** and the others as **Slave** monitors. If the system only has one monitor, choose **Off**.
- d: Activation of video doorphone energy saving mode. When the energy saving mode is activated (**On**), product power consumption is reduced. The intercom panel is placed on standby, therefore the monitor no longer receives calls.

## 4. Monitor ringtone deactivation

This function turns off the monitor ringtone for a certain period (snooze, etc.). The monitor LEDs will still flash to signal incoming calls.

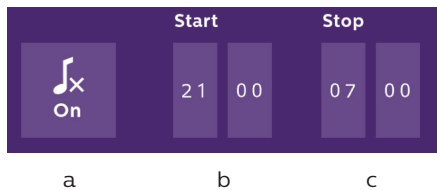

- a: activate (**On**) / deactivate (**Off**) the monitor's ringtone.
- b: Time when the ringtone will be deactivated.
- c: Time when the ringtone will be reactivated.

## 5: Time and date settings

 and  : adjust

 : valid, enables access to the next setting and next menu

a: menu 1: time and date settings

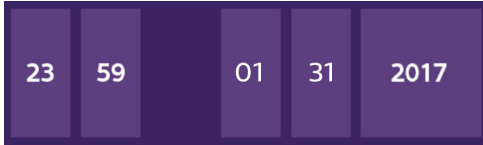

b: menu 2: date (applies to the main menu only) and time format settings.





## 6: Reset menu



Return product to factory settings and restore default values, disable ringer, configure options and adjust audio and image settings and date and time.

# 7. USER MANUAL

## Response to a call:

- Pressing the intercom panel button triggers an audible signal and the monitor turns on. You have up to 20s to answer the call. Once the visitor has been identified, press the  key to begin talking.

- After 2 minutes, the communication ends and the screen returns to the welcome screen. If the conversation ends before the 120s are up, press  to end the communication. The screen returns to the home page.

- To refresh the picture, press  on the home screen. To extend the conversation by a further 120s, press .

- You can actuate an electric lock or strike plate by pressing  (only when video is being displayed)

- You can actuate an automatic gate opener by pressing  (only when video is being displayed)

## Standby

- The screen is automatically placed on standby which means the screen enters sleep mode for energy saving and screen sustainability purposes.

- If the monitor is on any other menu than the main menu, it will automatically revert to the main screen after 15s of inactivity.
- If the monitor is on the main menu, it will automatically go into standby after 15s of inactivity.
- Pressing any button will bring the screen out of standby.

## 8. TECHNICAL CHARACTERISTICS

### Monitor:

ref.: 531003 (WelcomeEye Comfort)

ref.: 531005 (WelcomeEye Compact)

- 2 wires
- 7" screen (Comfort), 4.3" screen (Compact)
- Resolution 800 x 480 (Comfort), 480 x 272 (Compact)
- Current consumption: 460mA (Comfort), 400mA (Compact)
- Power consumption: 11.1W (Comfort), 9.6W (Compact)
- 6 ringtones (85dB)
- Dimensions: 142(h) x 210(w) x 15(d) (Comfort), 116(h) x 146(w) x 16(d) (Compact)

### Intercom panel:

ref.: 538200

- C-MOS colour sensor 900TVL
- Viewing angle H100° / V75°
- Night vision (white LEDs)
- Strike plate control 12V / 1.1A / 1.5s
- Gate control: breaking capacity 12V/2A
- IP44
- Operating temperature: -20°C / +50°C

### WelcomeEye Outdoor: (Additional intercom panel)

ref.: 531006

- C-MOS colour sensor 900TVL
- Viewing angle H130° / V 90°
- Night vision (white LEDs)
- Strike plate control 12V / 1.1A / 1.5s
- Gate control: breaking capacity 12V / 2A
- RFID (125kHz)
- IP44
- Operating temperature: -20°C / +50°C
- Dimensions: 168(h) x 82(w) x 38(d)

### WelcomeEye AddComfort: (additional monitor)

ref.: 531003

- 2 wires
- 7" screen
- Resolution: 800 x 480
- Current consumption: 460mA
- Power consumption: 11.1W
- 6 ringtones (85dB)
- Dimensions: 142(h) x 210(w) x 15(d)

### WelcomeEye AddCompact: (additional monitor)

ref.: 531005

- 2 wires
- 4.3" screen
- Resolution: 480 x 272
- Current consumption: 400mA
- Power consumption: 9.6W
- 6 ringtones (85dB)
- Dimensions: 116 (h) x 146 (l) x 16 (d)

### WelcomeEye Cam: (additional camera)

ref.: 531007

- C-MOS colour sensor 900TVL
- Viewing angle: H95° / V75°
- Operating temperature: -20°C / +50°C
- Protection rating: IP66

## 9. ACCESSORIES

**WelcomeEye AddCompact** - DES 9300 DDE (ref.: 531005)\*

**WelcomeEye AddComfort** - DES 9500 DDE (ref.: 531003)\*

**WelcomeEye Cam** - DES 9900 CVC (ref.: 531007)

**WelcomeEye Outdoor** - DES 9900 VOS (ref.: 531006)\*\*

**WelcomeEye Lock** - DES 1000 EDL (ref.: 531008)

**WelcomeEye Lock** - DES 1100 EDL (ref.: 531009)

**WelcomeEye Power** - DES 1000 DPS (ref.: 531010)\*\*

**WelcomeEye TAG** - DES 1000 ACI (ref.: 531011)\*\*

\* Refer to the complete WelcomeEye Comfort/Compact instructions available on the [www.philips.com](http://www.philips.com) website for more information.

\*\* Refer to the complete WelcomeEye Connect/Touch instructions available on the [www.philips.com](http://www.philips.com) website for more information.

## 10. FAQ

Failure	Cause	Solution
• The monitor does not turn on	• The monitor is not connected to a power source	• Verify that the power supply is properly connected and turned on • Check the polarity on the monitor or at the power supply output
	• Poor connection or short circuit on the line	• Resolve the connection problem

<ul style="list-style-type: none"> <li>Does not work when installed for the first time</li> </ul>	<ul style="list-style-type: none"> <li>Connection error</li> </ul>	<ul style="list-style-type: none"> <li>The device is equipped with major protections. Disconnect the power supply for at least 1mn, correct the installation error and reconnect. Please note that none of the protective measures will be effective if the product is connected directly to the 230V AC supply and that this error is not covered by the warranty.</li> </ul>
	<ul style="list-style-type: none"> <li>Reversed polarity of the supply voltage</li> </ul>	
	<ul style="list-style-type: none"> <li>Short-circuit on the line</li> </ul>	
<ul style="list-style-type: none"> <li>The intercom panel is on but the monitor does not ring</li> </ul>	<ul style="list-style-type: none"> <li>Switch configuration of the intercom panel</li> </ul>	<ul style="list-style-type: none"> <li>Verify that the intercom panel is not programmed in dual-family mode. <b>Reminder:</b> single-family = switch 2 set to ON, dual-family = switch 2 set to OFF. Don't forget to turn the power off for 5 seconds to activate the new settings (page 6)</li> </ul>
	<ul style="list-style-type: none"> <li>Configuration menu of the monitor</li> </ul>	<ul style="list-style-type: none"> <li>Verify that the monitor is valid</li> </ul>
	<ul style="list-style-type: none"> <li>Connection</li> </ul>	<ul style="list-style-type: none"> <li>Verify that the monitor is connected to 1 and 2 of the intercom panel (for single-family use)</li> </ul>
	<ul style="list-style-type: none"> <li>Energy saving mode activated</li> </ul>	<ul style="list-style-type: none"> <li>See system option configuration in the instructions.</li> </ul>
<ul style="list-style-type: none"> <li>Poor picture and/or sound</li> </ul>	<ul style="list-style-type: none"> <li>Environment</li> </ul>	<ul style="list-style-type: none"> <li>Check that the wires used are the correct size and that the Video doorphone's connection wires are not in the same sheath as the 230V AC wires</li> </ul>
<ul style="list-style-type: none"> <li>Purple picture</li> </ul>	<ul style="list-style-type: none"> <li>Connection</li> </ul>	<ul style="list-style-type: none"> <li>The connection cable must not be tangled</li> </ul>
<ul style="list-style-type: none"> <li>Image is too bright</li> </ul>	<ul style="list-style-type: none"> <li>Camera position</li> </ul>	<ul style="list-style-type: none"> <li>Do not expose the lens of the camera directly to sunlight or to a reflective surface.</li> </ul>
		<ul style="list-style-type: none"> <li>Check the monitor settings</li> </ul>
<ul style="list-style-type: none"> <li>The volume of the intercom panel is too low</li> </ul>	<ul style="list-style-type: none"> <li>Settings</li> </ul>	<ul style="list-style-type: none"> <li>Re-enter the settings on the back of the intercom panel</li> </ul>
<ul style="list-style-type: none"> <li>The volume from the intercom panel is too low</li> </ul>	<ul style="list-style-type: none"> <li>The microphone hole of the intercom panel is blocked</li> </ul>	<ul style="list-style-type: none"> <li>Verify and rectify</li> </ul>

<ul style="list-style-type: none"> <li>• The Dual-family mode is not working</li> </ul>	<ul style="list-style-type: none"> <li>• Configuration</li> </ul>	<ul style="list-style-type: none"> <li>• Verify that the intercom panel is not programmed in dual-family mode. <b>Reminder:</b> single-family = switch 2 set to ON, dual-family = switch 2 set to OFF. Don't forget to turn the power off for five seconds to activate the new settings</li> </ul>
	<ul style="list-style-type: none"> <li>• Configuration menu of the monitors</li> </ul>	<ul style="list-style-type: none"> <li>• Verify that the monitors are valid (BOTH of them)</li> </ul>
	<ul style="list-style-type: none"> <li>• Connection</li> </ul>	<ul style="list-style-type: none"> <li>• The monitors of family 1 must be connected to 1 and 2 of the intercom panel, those of family 2 to 3 and 4</li> </ul>
<ul style="list-style-type: none"> <li>• The additional monitor is not working</li> </ul>	<ul style="list-style-type: none"> <li>• Configuration</li> </ul>	<ul style="list-style-type: none"> <li>• Verify that you have correctly configured the menus of your monitors with 1 SINGLE master terminal, the others MUST be configured as slaves</li> </ul>
	<ul style="list-style-type: none"> <li>• Connection</li> </ul>	<ul style="list-style-type: none"> <li>• Verify that the additional monitor is connected to 1 and 2 of the intercom panel for single-family operation</li> </ul>
<ul style="list-style-type: none"> <li>• The additional intercom panel is not working</li> </ul>	<ul style="list-style-type: none"> <li>• Configuration</li> </ul>	<ul style="list-style-type: none"> <li>• Verify the position of switch 1 on the panels; it must be different. Don't forget to turn the power off for five seconds to activate the new settings</li> </ul>
	<ul style="list-style-type: none"> <li>• Configuration menu of the monitors</li> </ul>	<ul style="list-style-type: none"> <li>• Verify that the monitors are valid (BOTH of them)</li> </ul>
<ul style="list-style-type: none"> <li>• The electric strike plate or lock does not function</li> </ul>		<ul style="list-style-type: none"> <li>• The strike plate or electric lock that you are ordering must have a mechanical memory. The strike plate current cannot exceed 1.1A.</li> <li>• Connect it directly to terminals 7 and 8 at the back of the intercom panel (no need to observe polarity).</li> <li>• The opening function is only possible if the video of the respective intercom panel is displayed.</li> </ul>

**Notes:** To check whether or not the product is faulty, we recommend connecting it over a short distance (3m of wiring). If the symptoms persist, the product is faulty. If not, check the installation and cable used.



## 11. TECHNICAL ASSISTANCE - WARRANTY

This product is guaranteed for parts and labour in our workshops.

The warranty does not cover: consumables (batteries, etc.) and damage caused by misuse, improper use, improper installation, external intervention, damage due to physical or electrical shocks, dropping, or atmospheric phenomena.

- Do not open the device, as this will void the warranty.
- If the unit is returned for After Sales Service, protect the screen to prevent scratching.
- Clean with a soft cloth only, no solvents. The guarantee is void if parts have been dismantled. Before cleaning it, disconnect the equipment or switch it off at the mains.

 **Warning:** Do not use any gasoline or carboxylic acid, alcohol or similar treatment. In addition to damaging your device, the fumes are also hazardous to your health and are explosive.

Do not use any tool that can conduct voltage (wire brush or other sharp tool, etc.) for cleaning.

**The till receipt or invoice is your proof of purchase date.**

If necessary, the contacts and opening hours of our technical assistance centres are available on the [www.philips.com](http://www.philips.com) website.

WARRANTY CARD		
Mr / Mrs :	_____	
Phone number :	_____	
Address :	_____ _____	
E-mail :	_____	
Date of purchase :	____/____/____ (DD/MM/YYYY)	
Dealer :	_____	
Dealer Phone :	_____	
Dealer address :	_____	
Serial number	<table border="1"><tr><td>PHI/1031/</td></tr></table>	PHI/1031/
PHI/1031/		
<b>Important :</b> Please keep this warranty card with your proof of purchase.		

Philips and Philips' shield emblem are registered trademarks of Koninklijke Philips N.V. and are used under licence. This product has been manufactured by and is sold under the responsibility of CFI Extel SAS, and CFI Extel SAS is the sole guarantor of this product.

## 12. SAFETY PRECAUTIONS

Any damage caused by a failure to adhere to the manual shall void the warranty. We assume no liability for damages resulting therefrom!

We cannot be held responsible for any damage to property or persons caused by incorrect use or a failure to adhere to the safety instructions.

This product has been manufactured in full compliance with safety instructions. In order to maintain this status and get the most out of the product, users must adhere to the safety instructions and warnings contained in this manual.



This symbol indicates that there is a risk of electric shock or short-circuit.

- You should only use this product with a voltage between: 100-240 Volts and 50-60 hertz. Never attempt to use this device with a different voltage.
- Ensure that all the system's electrical connections conform to the instructions for use.
- In commercial establishments, ensure that you adhere to the electrical installation accident prevention regulations.
- In schools, training facilities, workshops, etc. qualified personnel must be on hand to monitor electronic equipment operation.
- You must follow the instructions for use of any other devices connected to the system.
- Please contact an experienced person if you have any doubts regarding equipment operation or safety.
- Never plug in or unplug electrical equipment with wet hands.
- When installing this product, check that the power supply cables are not at risk of being damaged.
- Never replace damaged electrical cables yourself! In this case, remove them and call an expert.
- The mains supply should be located close to the device and must be easily accessible.
- An easily accessible cut-off system (switch disconnecter, circuit breaker, equivalent system) must be integrated into the building's wiring installation for the equipment connected to the power grid.
- Keep a minimum distance around the device to guarantee sufficient ventilation.
- Ventilation should not be blocked by covering the ventilation opening with an object such as a newspaper, tablecloth or curtain, etc.).
- No open flame source such as a burning candle must be placed on the device.
- Respect the product's operating temperature.
- The device must not be exposed to liquid flow or splashing. Do not place any objects filled with liquid such as vases on the device.

## 13. FCC/CE WARNING

**Note:** This equipment has been tested and found to comply with the limits for the Class B, in compliance with current European safety standards. These limits are designed to provide reasonable protection against interference in a residential installation. This equipment uses and emits a radio frequency energy and may cause interference with radio communications if not installed and used according to the instructions.

However, there is no guarantee that there will be zero interference in any given installation. If this equipment causes interference with radio or TV reception, which can be determined by starting and stopping the equipment, we recommend resolving this interference by using at least one of the following measures:

- Reorient or move the receiving antenna
- Increase the distance between the equipment and the receiver
- Use a plug on a different circuit to that being used by the receiver

## 14. DECLARATION OF CONFORMITY

The undersigned, CFI-Extel, declares that the WelcomeEye radioelectric equipment complies with the 2014/53/EU directive. The full text of the EU declaration of conformity is available at the following address: [www.cfi-extel.com](http://www.cfi-extel.com).



**FR** - Ne jetez pas les piles et les appareils hors d'usage avec les ordures ménagères. Les substances dangereuses qu'ils sont susceptibles de contenir peuvent nuire à la santé et à l'environnement. Faites reprendre ces appareils par votre distributeur ou utilisez les moyens de collecte sélective mise à votre disposition par votre commune. Directive WEEE 2012/19/EU

**GB** - Don't throw batteries or out of order products with the household waste (garbage). The dangerous substances that they are likely to include may harm health or the environment. Make your retailer take back these products or use the selective collect of garbage proposed by your city. Directive WEEE 2012/19/EU

**D** - Verbrauchte Batterien und nicht mehr benützte Geräte sind Sondermüll. Sie enthalten möglicherweise gesundheits- und umweltschädliche Substanzen. Geben Sie alte Geräte zur fachgerechten Entsorgung beim Gerätehändler ab bzw. benutzen Sie die örtlichen Recyclinghöfe.

Directive WEEE 2012/19/EU

**NL** - De lege batterijen en oude apparaten niet met het huisvuil meegeven; deze kunnen gevaarlijke stoffen bevatten die de gezondheid en het milieu schaden. De oude apparaten door uw distributeur laten innemen of de gescheiden vuilinzameling van uw gemeente gebruiken. Directive WEEE 2012/19/EU

**PL** - Nie wyrzucać zużytych baterii i zepsutych urządzeń do śmieci. Substancje niebezpieczne, które mogą zawierać są szkodliwe dla zdrowia i środowiska. Urządzenia należy zwrócić do dystrybutora lub wykorzystać system zbiórki selektywnej dostępny na terenie gminy. Dyrektywa WEEE 2012/19/EU

**IT** - Non gettare le pile e le apparecchiature fuori uso insieme ai rifiuti domestici. Le sostanze dannose contenute in esse possono nuocere alla salute dell'ambiente. Restituire questo materiale al distributore o utilizzare la raccolta differenziata organizzata dal comune. Directive WEEE 2012/19/EU

**ES** - No tire las pilas ni los aparatos inservibles con los residuos domésticos, ya que las sustancias peligrosas que puedan contener pueden perjudicar la salud y al medio ambiente.

Pídale a su distribuidor que los recupere o utilice los medios de recogida selectiva puestos a su disposición por el ayuntamiento. Directive WEEE 2012/19/EU

**PT** - Não junte as pilhas nem os aparelhos que já não se usam com o lixo caseiro. As substâncias perigosas que ambos podem conter podem ser prejudiciais para a saúde e para o ambiente. Entregue esses aparelhos ao seu lixeiro ou recorra aos meios de recolha selectiva ao seu dispor. Directive WEEE 2012/19/EU



Pour en savoir plus : [www.quefairedemesdechets.fr](http://www.quefairedemesdechets.fr)



**FR** - Ce symbole indique que l'appareil s'installe et s'utilise uniquement à l'intérieur

**GB** - This symbol indicates that the device must only be installed and used indoors

**D** - Dieses Symbol zeigt an, dass das Gerät nur innen installiert und verwendet wird

**NL** - Dit symbool betekent dat het apparaat alleen binnen mag worden geïnstalleerd en gebruikt

**PL** - Ten symbol wskazuje, iż urządzenie przeznaczone jest wyłącznie do montażu i użytku wewnętrznego

**IT** - Questo simbolo indica che l'apparecchio si installa e si utilizza unicamente all'interno

**ES** - Este símbolo indica que el aparato se instala y utiliza únicamente en el interior

**PT** - Este símbolo indica que o aparelho só pode ser instalado e usado em interiores



**FR** - La protection des appareils qui portent ce symbole est assurée par une double isolation et ne requiert pas de branchement de sécurité à la terre/masse électrique.

**GB** - The protection of devices bearing this symbol is guaranteed by double insulation, they do not require a safety connection to electrical earth.

**D** - Der Schutz der dieses Symbol tragenden Geräte wird durch eine zweifache Isolation gewährleistet und erfordert keinen elektrischen Schutzanschluss an Erde/Masse.

**NL** - Apparatuur die voorzien is van dit symbool, wordt beschermd door een dubbele isolatie en vereist geen beveiligde elektriciteitsaansluiting op de aarde/massa.

**PL** - Urządzenia oznaczone takim symbolem są chronione podwójną izolacją i nie wymagają one bezpiecznego podłączenia do uziemienia/masy.

**IT** - La protezione delle apparecchiature che riportano questo simbolo è garantita da un doppio isolamento e non necessita di messa a terra/collegamento a massa.

**ES** - La protección de los aparatos que llevan este símbolo está garantizada por un doble aislamiento y no requiere una conexión de seguridad a tierra/masa eléctrica.

**PT** - A proteção dos aparelhos que contêm este símbolo é assegurada através de isolamento dupla e não necessita de ligações de segurança à terra/massa elétrica.



**FR** - Courant continu

**GB** - Direct Current

**D** - Gleichstrom

**NL** - Directstroom

**PL** - Prąd stały

**IT** - Corrente continua

**ES** - Corriente continua

**PT** - Corrente continua



**FR** - Courant alternatif

**GB** - Alternating Current

**D** - Wechselstrom

**NL** - Gelijkstroom

**PL** - Prąd zmienny

**IT** - Corrente alternata

**ES** - Corriente alterna

**PT** - Corrente alterna

**F. La marque commerciale Philips est une marque déposée par Koninklijke Philips N.V.**

**GB. The Philips trademarks are registered trademarks of Koninklijke Philips N.V.**

**D. Die Philips Warenzeichen sind eingetragene Warenzeichen der Koninklijke Philips N.V.**

**NL. De handelsmerken van Philips zijn gedeponeerde handelsmerken van Koninklijke Philips N.V.**

**PL. Znaki handlowe Philips są zarejestrowanymi znakami handlowymi Koninklijke Philips N.V.**

**IT. I marchi Philips sono marchi registrati di proprietà di Koninklijke Philips N.V.**

**ES. Las marcas registradas de Philips son marcas registradas de Koninklijke Philips N.V.**

**PT. As marcas registadas da Philips são marcas registadas da Koninklijke Philips N.V.**

**PHILIPS**