

# GLOBO

LIGHTING

[www.globo-lighting.com](http://www.globo-lighting.com)

48563-30/48563-30S

Frequency Bandwidth	Maximal radiation transmitting power
2412-2472MHz	10dBm

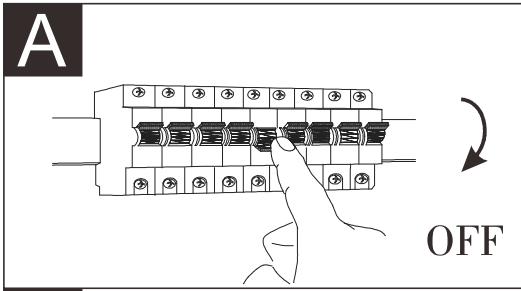

**B**

LED MAX 30W 36V  
220-240V~ 50/60Hz

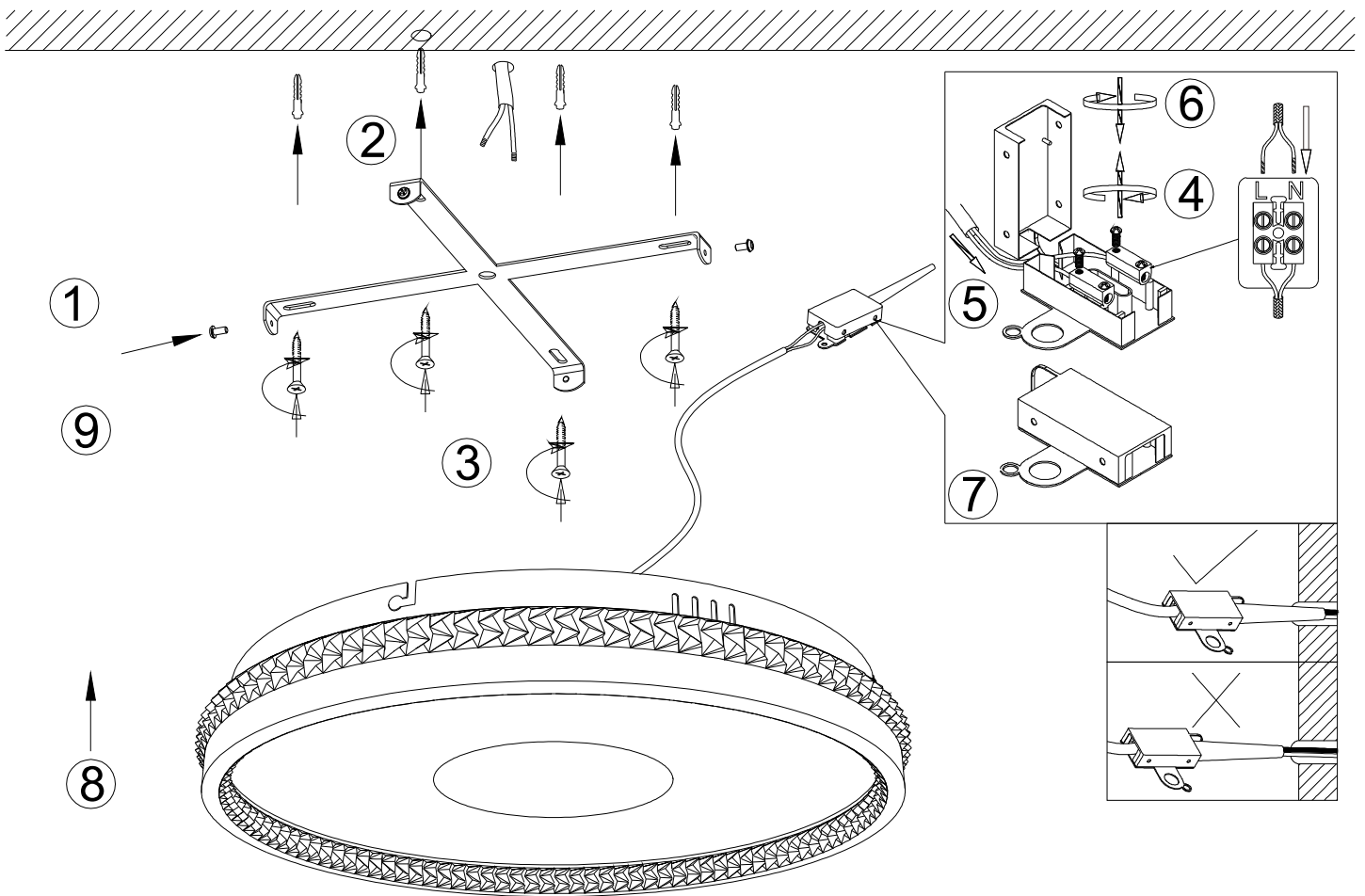

GLOBO Handels GmbH  
Gewerbestr. 3  
A-9184 Sankt Peter  
AUSTRIA  
[www.globo-lighting.com](http://www.globo-lighting.com)  
[office@globo-lighting.com](mailto:office@globo-lighting.com)

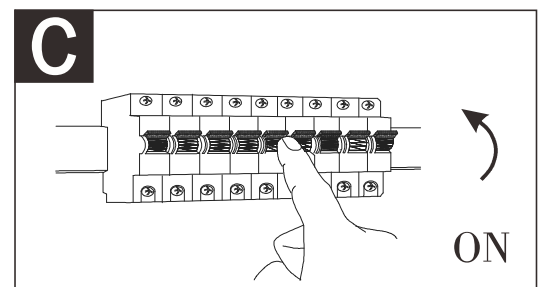

# Reset remote control

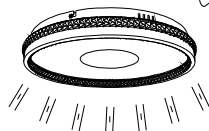
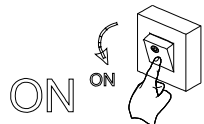
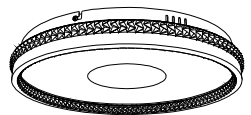

2~3S

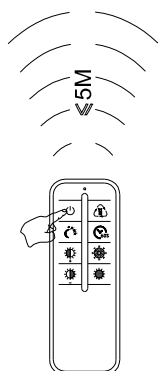
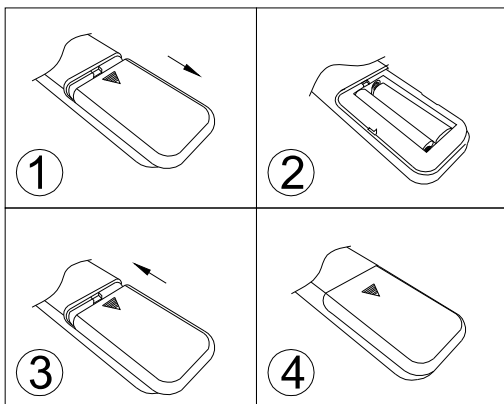
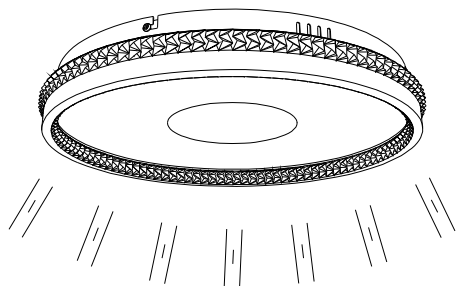

**BATTERY DATA**  
 2x AAA battery\* incl.  
 \*Manufacturer: shenzhen gmccl Technology Co., Ltd.  
 Address: 2205&2206, Building G, Hualian City Panorama, 27 Dalang Community, Xin'an Street, Bao'an District, Shenzhen, Guangdong Province  
 Model: R03P UM-4 1.5V

**SAFETY INSTRUCTIONS**

 ON/OFF	 COLOUR FIXING
 NIGHT LIGHT	 Timer 60sec.
 LM ↑	 6500K ↑ 2700K
 LM ↓	 6500K ↓ 2700K

# Wall switch

 ON 2700K
 OFF T < 3sec. 4000K
 ON T < 3sec. 6500K
 OFF T < 3sec. NIGHT LIGHT

## Lichtquelle:

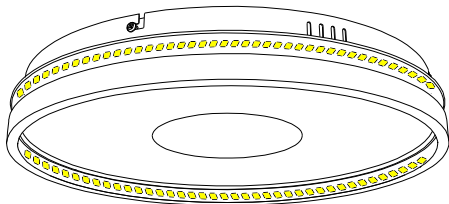

### DEU:

#### Lichtquelle:

Die Lichtquelle ist nicht tauschbar, weil sie konstruktionsbedingt fest mit dem umgebenden Produkt verbunden ist.

Dieses Produkt enthält eine Lichtquelle der Energieeffizienzklasse <E>.

  Die LED - Lichtquelle ist nicht austauschbar.



  Das Betriebsgerät kann nur durch einen Fachmann ausgetauscht werden.

### GBR:

#### Light source:

The light source is not interchangeable because it is determined by the surrounding product design.

This product contains a light source of energy efficiency class <E>.



  The LED - light source cannot be replaced.



  The control gear can be replaced by a professional.

### BIH&HR:

#### Izvor svjetla :

Izvor svjetla nije zamjenjiv , jer je konstrukcijski pričvršćen na proizvod .  
Ovaj proizvod sadržava izvor svjetlosti klase energetske učinkovitosti <E>.



  LED – izvor svjetla nije moguće zamjeniti



  Pogonski uređaj smije zamjeniti samo stručna osoba .

### BG:

#### Източник на светлина:

Източникът на светлина не може да се подменя, тъй като поради конструкцията си е трайно фиксиран към заобикалящия го продукт.  
Този продукт включва светлинен източник с клас на енергийна ефективност <E>.

  LED източникът на светлина не може да се подменя.



  Устройството за управление може да се подменя само от специалист.



### CZ:

#### Zdroj světla:

Světelný zdroj není možné vyměnit, protože je díky své konstrukci pevně spojený s produktem.

Tento výrobek obsahuje světelný zdroj s třídou energetické účinnosti <E>.



  Světelný zdroj není vyměnitelný.

  Výměna předřadníku pouze odborníkem

### DK:

#### Lyskilde:

Lyskilden kan ikke udskiftes, fordi den er fast forbundet med det omgivende produkt.  
Dette produkt indeholder en lyskilde i energieffektivitetsklasse < E > .

  LED- lyskilden kan ikke udskiftes.



  Driftsenheden kan kun skiftes af en fagperson.

### ET:

#### Valgusallikas:

Valgusallikas ei ole välja vahetatav, sest ta on tootega ehituslikult kindlalt seotud.  
Toode sisaldab energiatõhususe klassi <E> valgusallikat.

  LED - valgusallikat ei saa asendada.

  Juhtseadmed võib asendada professionaalne.

### FI:

#### Valonlähde:

Valonlähdettä ei voi vaihtaa uuteen, sillä se on rakenteellisesti yhdistetty ympäröivään tuotteeseen.

Tämä tuote sisältää valonlähteen, jonka energiatehokkuusluokka on <E>.

  LED-valonlähdettä ei voi vaihtaa uuteen.



  Vain ammattihenkilö voi vaihtaa liitäntälaitteen.



### FR:

#### Source lumineuse:

La source lumineuse n'est pas remplaçable car elle est, de par la construction du produit, liée de façon permanente à celui-ci.

Ce produit contient une source lumineuse de classe d'efficacité énergétique <E>.

  La source lumineuse LED n'est pas remplaçable.

  L'unité de contrôle ne peut être remplacée que par un spécialiste.

**GR:**

**Φωτεινή πηγή:**

Η φωτεινή πηγή δεν μπορεί να αντικατασταθεί, επειδή είναι για κατασκευαστικούς λόγους σταθερά συνδεδεμένη με το προϊόν που την περιβάλλει.

Το προϊόν αυτό περιέχει φωτεινή πηγή της τάξης ενεργειακής απόδοσης <E>.



Η φωτεινή πηγή LED δεν αντικαθίσταται.



Η λειτουργική συσκευή μπορεί να αντικατασταθεί μόνο από έναν ειδικό.

**HU:**

**Fényforrás:**

A fényforrás nem cserélhető, mert felépítése miatt szilárdan csatlakozik a termékhez. Ez a termék egy <E> energiahatékonysági osztályú fényforrást tartalmaz.



A fényforrás nem cserélhető



Az előtetet csak szakértők cserélhetik ki.

**Isländisch/IS:**

**Ljósgrafi:**

Ljósgrafinn er ekki útskiptanlegur vegna þess að hann er háður umliggjandi hönnun vörunnar.

Varan inniheldur ljósgrafa í orkuflokki <E>.

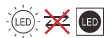

Ekki er hægt að skipta um LED-ljósgrafann.



Aðeins fagmenn mega skipta um stjórnbúnaðinn.

**IT:**

**Sorgente luminosa:**

La sorgente luminosa non è intercambiabile perché è saldamente collegata al prodotto per via del suo design.

Questo prodotto contiene una sorgente luminosa di classe di efficienza energetica <E>.

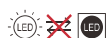

La sorgente luminosa a LED non può essere sostituita.



L'alimentatore può essere sostituito solo da personale

**LV:**

**Gaismas avots:**

Gaismas avotu nevar nomainīt, jo tas konstrukcijā ir cieši savienots ar izstrādājuma apkārtējo daļu.

Šis ražojums satur gaismas avotu, kura energoefektivitātes klase ir <E>.

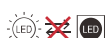

LED apgaismes līdzekli nevar nomainīt.



Vadības ierīci var nomainīt speciālists.

**LT:**

**Šviesos šaltinis:**

Šis šviesos šaltinis yra nekeičiamas, nes jis prijungtas prie gaminio pagal jo konstrukciją.

Šiame gaminyje yra šviesos šaltinis, kurio energijos vartojimo efektyvumo klasė <E>.



LED šviesos šaltinis yra nekeičiamas.



Valdymo įtaisą gali pakeisti tik tam kvalifikuotas

**NL:**

**Lichtbron:**

De lichtbron kan niet worden vervangen, omdat deze vanwege de constructie vast met het product eromheen verbonden is.

Dit product bevat een lichtbron van energie-efficiëntieklasse <E>.



De LED-lichtbron kan niet worden vervangen.



Het apparaat kan alleen door een vakman worden vervangen.

**Norwegisch/Norwegian / NO:**

**Lyskilde:**

Lyskilden kan ikke byttes fordi den sitter fast i produktet.

Dette produktet inneholder en lyskilde i energiklasse <E>.



LED-lyspæren kan ikke byttes.



Drivereheten kan kun byttes av fagmann.

**PL:**

**Źródło światła:**

Źródła światła nie można wymienić, ponieważ jest zintegrowane z produktem ze względu na swoją konstrukcję.

Ten produkt zawiera źródło światła o klasie efektywności energetycznej <E>.



LED - źródło światła nie może być wymienione.



Urządzenie sterujące może zostać wymienione przez

**PT:**

**Fonte de Luz:**

A fonte de luz não é substituível porque devido às suas características construtivas está fixada de forma permanente ao produto circundante.

Este produto contém uma fonte de luz da classe de eficiência energética <E>.

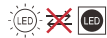

Lâmpada não substituível.



Substituição do equipamento de controlo por um profissional.

**RO:**

**Sursa de lumina:**

Sursa de lumina nu este înlocuibilă ea fiind parte constructivă a produsului. Acest produs conține o sursă de lumină cu clasa de eficiență energetică <E>.



Sursa de lumina nu poate fi înlocuită



Driverul poate fi înlocuit doar de către personal specializat

**RUS:**

**Источник света:**

Источник света не является взаимозаменяемым, поскольку это определяется конструкцией смежного продукта.

Данный продукт содержит источник света класса энергоэффективности <E>.



Светодиодный источник света не подлежит замене.



Устройство управления может заменяться только квалифицированным специалистом.

**SRB:**

**Izvor svetlosti:**

Izvor svetlosti nije zamenljiv, jer je zbog svog dizajna čvrsto povezan sa proizvodom koji ga okružuje.

Ovaj proizvod sadrži izvor svetlosti klase energetske efikasnosti <E>.

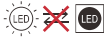

LED izvor svetlosti nije zamenljiv.



Upravljački uređaj može da zameni samo specijalista.

**SK:**

**Zdroj svetla:**

Svetelný zdroj nie je možné vymeniť, pretože je vďaka svojej konštrukcii pevne spojený s produktom.

Tento výrobok obsahuje svetelný zdroj triedy energetickej účinnosti <E>.



Svetelný zdroj nie je vymeniteľný.



Výmena predradníka len odborníkom.

**SI:**

**Izvor svetlobe:**

Vir svetlobe ni zamenljiv, ker je določen z zasnovno izdelka v okolici.

Ta izdelek vsebuje svetlobni vir razreda energijske učinkovitosti <E>.

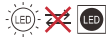

Svetlobni vir ni mogoče zamenjati.



Krmilno napravo lahko zamenja samo strokovno usposobljena oseba

**ES:**

**Fuente de luz:**

La fuente de luz no es sustituible porque está fija en el producto desde la construcción. Este producto contiene una fuente luminosa de la clase de eficiencia energética <E>.

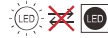

Bombilla no reemplazable.



Sustitución del aparato por un profesional.

**SE:**

**Ljuskälla:**

Ljuskällan är inte utbytbar, eftersom den på grund av konstruktionen är fast integrerad i den omgivande produkten.

Denna produkt innehåller en ljuskälla med energieffektivitetsklass <E>



LED-ljuskällan kan inte bytas ut.



Driftdonet kan endast bytas ut av en fackman.

**TR:**

**Işık kaynağı:**

Konstrüksiyon gereği çevreleyen ürün ile sabit bir şekilde bağlı olduğu için ışık kaynağı değiştirilemez.

Bu ürün, <E> enerji sınıfından bir ışık kaynağına sahiptir.



LED ışık kaynağı değiştirilemez.



İşletme cihazı sadece bir uzman tarafından değiştirilebilir.

**UK:**

**Джерело світла:**

Джерело світла не можна обміняти, оскільки воно міцно пов'язане з навколишнім виробом завдяки своїй конструкції.

Цей виріб містить джерело світла класу енергоефективності <E>.



— джерело світлодіодного світла не можна замінювати.



— лише фахівець може замінювати пристрій керування.