

LEISTUNGSERKLÄRUNG

Nummer: GAH/LE-006

gem. Verordnung (EU) 305/2011 - Nr. GAH 6123

- ETA 08/0165
GAH Winkelverbinder
- Typ Nr.: 8573, 8590, 8591, 8592, 8593, 8594, 8595, 8596, 8597, 8612, 8613, 8614, 8615, 8617, 8620, 8621, 8623, 8624, 8625, 8625 FH, 8626, 8626 FH, 8627, 8632 FH, 8633 FH, 8634, 8635, 8636, 8637, 8638, 8640, 8641, 8644, 8645, 8622, 8628, 8629, 8632, 8633, 8654, 8655, 8791, 8792, 8793, 8794, 8795, 8799.
Die Winkelverbinder sind mit Herstellerzeichen, CE und der Nummer des Karlsruher Instituts für Technologie gekennzeichnet. Alle weiteren Angaben, wie das Fertigungsdatum sind auf dem Verpackungsetikett angegeben.
- Die Winkelverbinder sind für die Verbindung von tragenden Holzbauteilen bestimmt, wie eine Verbindung zwischen einem Holzträger und einer Pfette.
- Gust. Alberts GmbH & Co. KG
Blumenthal 2
58849 Herscheid
- entfällt
- System der Leistungsbeständigkeit: 2+
- entfällt
- Das Karlsruher Institut für Technologie (KIT), NB-Nr. 0769, hat die Erstinspektion des Werkes und der werkseigenen Produktionskontrolle sowie die laufende Überwachung, Bewertung und Evaluierung der werkseigenen Produktionskontrolle nach dem System 2+ vorgenommen und folgendes ausgestellt: Bescheinigung der Konformität zur werkseigenen Produktionskontrolle, Nr. 0769-CPR-6123.

9. Erklärte Leistung

Wesentliche Merkmale	Leistung	Harmonisierte techn. Spezifikation
Charakteristische Tragfähigkeit	siehe Anhang B der ETA 08/0165	
Steifigkeit	Keine Leistung festgelegt	
Duktilität	Keine Leistung festgelegt	
Sicherheit beim Brandfall Brandverhalten	Die Winkelverbinder sind aus Stahl gefertigt, klassifiziert als Euroklasse A1 nach EN 1350-1	EN 1350-1
Hygiene, Gesundheit und Umweltschutz	Keine Gefahrstoffe enthalten	
Dauerhaftigkeit und Gebrauchstauglichkeit	Die Winkelverbinder sind mit zufrieden- stellender Dauerhaftig- und Gebrauchs- tauglichkeit bewertet, wenn sie in Holz- konstruktionen mit Holzarten die in Eurocode 5 beschrieben sind, verwendet werden und unterliegen den Bedingungen der Serviceklassen 1 und 2, rostfreie Edelstähle Serviceklasse 3.	
Nachhaltiger Gebrauch natürlicher Ressourcen	keine Leistung festgelegt	
Identifizierung	siehe Anhang A der ETA 08/0165	

ETA 08/0165
ETAG 015 Dreidimensionale Nagelplatten

- Die Leistung des Produkts gemäß den Nummern 1 und 2 entspricht der erklärten Leistung nach Nummer 9. Verantwortlich für die Erstellung dieser Leistungserklärung im Einklang mit der Verordnung (EU) Nr. 305/2011 ist allein der Hersteller gemäß Nummer 4. Unterzeichnet für den Hersteller und im Namen des Herstellers von:

Peter Feldmann

Leiter Qualitätsmanagement

Name

Funktion

Herscheid, den 11. Mai 2019

i.A.

Ort / Datum der Ausstellung

Unterschrift



ETA-Danmark A/S
Göteborg Plads 1
DK-2150 Nodhavn
Tel. +45 72 24 59 00
Fax +45 72 24 59 04
Internet www.etadanmark.dk

Authorized and notified according
to Article 29 of the Regulation (EU)
No 305/2011 of the European
Parliament and of the Council of 9
March 2011

MEMBER OF EOTA



European Technical Assessment ETA-08/0165 of 19/05/2017

General Part

Technical Assessment Body issuing the ETA and designated according to Article 29 of the Regulation (EU) No 305/2011: ETA-Danmark A/S

Trade name of the
construction product:

GAH Angle Brackets

Product family to which the
above construction product
belongs:

Three-dimensional nailing plate (angle bracket for wood
to wood connections)

Manufacturer:

Gust. Alberts GmbH & Co KG
Gewerbegebiet Grünenthal
D-55845 Herscheid
Tel. +49 2357 907 0
Fax +49 2357 907 189
Internet www.gah.de

Manufacturing plant:

Gust. Alberts GmbH & Co KG
Gewerbegebiet Grünenthal
D-55845 Herscheid

This European Technical
Assessment contains:

86 pages including 2 annexes which form an integral
part of the document

This European Technical
Assessment is issued in
accordance with Regulation
(EU) No 305/2011, on the
basis of:

Guideline for European Technical Approval (ETAG) No.
015 Three Dimensional Nailing Plates, April 2013, used
as European Assessment Document (EAD).

This version replaces:

The ETA with the same number issued on 2014-10-15

Translations of this European Technical Assessment in other languages shall fully correspond to the original issued document and should be identified as such.

Communication of this European Technical Assessment, including transmission by electronic means, shall be in full (excepted the confidential Annex(es) referred to above). However, partial reproduction may be made, with the written consent of the issuing Technical Assessment Body. Any partial reproduction has to be identified as such.

II SPECIFIC PART OF THE EUROPEAN TECHNICAL ASSESSMENT

1 Technical description of product and intended use

Technical description of the product

GAH angle brackets with and without rib and GAH hold-downs are one-piece non-welded, face-fixed nailing plates to be used in timber to timber or in timber to concrete or to steel connections. They are connected to construction members made of timber or wood-based products with profiled (ringed shank) nails according to EN 14592 and to concrete or steel members with bolts or metal anchors.

The angle brackets and hold-downs are made from pre-galvanized steel DX51D + Z 275 according to EN 10346 or stainless steel (1.4016, 1.4301, 1.4401, 1.4541, 1.4571) according to EN 10088-2 with minimum characteristic yield strength of $R_e = 250 \text{ N/mm}^2$, minimum characteristic tensile strength of $R_m = 330 \text{ N/mm}^2$ and are available with or without an embossed rib. Dimensions, hole positions and typical installations are shown in Annex A. GAH angle brackets and hold-downs are made with tolerances according to DIN 6930-2 from steel with tolerances according to EN 10143.

2 Specification of the intended use in accordance with the applicable EAD

The angle brackets and hold-downs are intended for use in making connections in load bearing timber structures, where requirements for mechanical resistance and stability and safety in use in the sense of the Basic Works Requirements 1 and 4 of Regulation (EU) 305/2011 shall be fulfilled.

The angle brackets and hold-downs may also be used for connections between a timber member and a member of concrete or steel.

The connection may be with a single angle bracket or with an angle bracket on each side of the fastened timber member.

The static and kinematic behaviour of the timber members or the supports shall be as described in Annex A and B.

The wood members may be of solid timber, glued laminated timber and similar glued members, or wood-based structural members with a characteristic density

from 290 kg/m^3 to 420 kg/m^3 . This requirement to the material of the wood members can be fulfilled by using the following materials:

- Structural solid timber according to EN 14081,
- Glulam according to EN 14080,
- LVL according to EN 14374,
- Parallam PSL,
- Intrallam LSL,
- Glued solid timber according to EN 14080,
- Cross laminated timber,
- Plywood according to EN 636

Annex B states the load-carrying capacities of the connections for a characteristic density of 350 kg/m^3 . For timber or wood based material with a lower characteristic density than 350 kg/m^3 the load-carrying capacities shall be reduced by the factor k_{dens} :

$$k_{\text{dens}} = \left(\frac{\rho_k}{350} \right)^2$$

Where ρ_k is the characteristic density of the timber in kg/m^3 .

The design of the connections shall be in accordance with Eurocode 5 or a similar national Timber Code. The wood members shall have a thickness which is larger than the penetration depth of the nails into the members.

The angle brackets and hold-downs are primarily for use in timber structures subject to the dry, internal conditions defined by service class 1 and 2 of Eurocode 5 and for connections subject to static or quasi-static loading.

The angle brackets and hold-downs can also be used in outdoor timber structures, service class 3, when a corrosion protection in accordance with Eurocode 5 is applied, or when stainless steel with similar or better characteristic yield and ultimate strength is employed.

To avoid contact corrosion, stainless steel angle brackets and hold-downs shall be used with nails made from stainless steel.

The scope of the brackets regarding resistance to corrosion shall be defined according to national provisions that apply at the installation site considering environmental conditions.

The provisions made in this European Technical Assessment are based on an assumed working life of the angle brackets of 50 years.

The indications given on the working life cannot be interpreted as a guarantee given by the producer or

Assessment Body, but are to be regarded only as a means for choosing the right products in relation to the expected economically reasonable working life of the works.

3 Performance of the product and references to the methods used for its assessment

Characteristic	Assessment of characteristic
3.1 Mechanical resistance and stability*)	
Characteristic load-carrying capacity	See Annex B
Stiffness	No performance determined
Ductility in cyclic testing	No performance determined
3.2 Safety in case of fire	
Reaction to fire	The brackets are made from steel classified as Euroclass A1 in accordance with EN 13501-1 and Commission Delegated Regulation 2016/364
3.3 Hygiene, health and the environment	
Influence on air quality	No dangerous materials
3.7 Sustainable use of natural resources (BR7)	No Performance Determined
3.8 General aspects related to the performance of the product	The brackets have been assessed as having satisfactory durability and serviceability when used in timber structures using the timber species described in Eurocode 5 and subject to the conditions defined by service class 1, 2 and 3
Identification	See Annex A

*) See additional information in section 3.8 – 3.9.

In addition to the specific clauses relating to dangerous substances contained in this European Technical Assessment, there may be other requirements applicable to the products falling within its scope (e.g. transposed European legislation and national laws, regulations and administrative provisions). In order to meet the provisions of the Construction Products Regulation, these requirements need also to be complied with, when and where they apply.

3.9 Methods of verification

Safety principles and partial factors

The characteristic load-carrying capacities are based on the characteristic values of the nail connections and the steel plates. To obtain design values the capacities have to be multiplied with different partial factors for the material properties, in addition the nail connection with the coefficient k_{mod} .

According to EN 1990 (Eurocode – Basis of design) paragraph 6.3.5 the design value of load-carrying capacity can be determined by reducing the characteristic values of the load-carrying capacity with different partial factors.

Thus, the characteristic values of the load-carrying capacity are determined also for timber failure $F_{Rk,H}$ (obtaining the embedment strength of nails subjected to shear or the withdrawal capacity of the most loaded nail, respectively) as well as for steel plate failure $F_{Rk,S}$. The design value of the load-carrying capacity is the smaller value of both load-carrying capacities.

$$F_{Rd} = \min \left\{ \frac{k_{mod} \cdot F_{Rk,H}}{\gamma_{M,H}}, \frac{F_{Rk,S}}{\gamma_{M,S}} \right\}$$

Therefore, for timber failure the load duration class and the service class are included. The different partial factors γ_M for steel or timber, respectively, are also correctly taken into account.

3.10 Mechanical resistance and stability

See annex B for the characteristic load-carrying capacity in the different directions F_1 to F_5 .

The characteristic capacities of the angle brackets / hold-downs are determined by calculation assisted by testing as described in the EOTA Guideline 015 clause 2.4.1.1.2. They should be used for designs in accordance with Eurocode 5 or a similar national Timber Code.

Threaded nails (ringed shank nails) in accordance with EN 14592

In the formulas in Annex B the capacities for threaded nails calculated from the formulas of Eurocode 5 are used assuming a thick steel plate when calculating the lateral nail load-carrying-capacity.

The load bearing capacities of the brackets has been determined based on the use of connector nails 4,0 x 40 mm in accordance with the German national approval for the nails.

The design models allow the use of fasteners described in the table on page 9 in Annex A

No performance has been determined in relation to ductility of a joint under cyclic testing. The contribution to the performance of structures in seismic zones, therefore, has not been assessed.

No performance has been determined in relation to the joint's stiffness properties - to be used for the analysis of the serviceability limit state.

3.11 Aspects related to the performance of the product

3.11.1 Corrosion protection in service class 1 and 2.

In accordance with ETAG 015 the angle brackets are made from pre-galvanized steel DX 51 D / Z 275 according to EN 10327:2004 with minimum yield strength R_e of 250 MPa, a minimum tensile strength R_m of 330 MPa and a minimum ultimate strain A_{80} of 22 %

3.11.2 Corrosion protection in service class 3.

In accordance with Eurocode 5 the angle brackets are made from stainless steel 1.4016, 1.4301, 1.4401, 1.4541 or 1.4571 according to EN 10088-2:2005 and the nails shall be produced from stainless steel.

3.12 General aspects related to the fitness for use of the product

The angle brackets and hold downs are manufactured in accordance with the provisions of this European Technical Assessment using the manufacturing processes as identified in the inspection of the plant by the notified inspection body and laid down in the technical documentation

The nailing pattern used shall be either the maximum or the minimum pattern as defined in Annex B.

The following provisions concerning installation apply:

The structural members – the components 1 and 2 shown in the figure on page 21 - to which the brackets are fixed shall be:

- Restrained against rotation. At a load F_4/F_5 , the component 2 is allowed to be restrained against rotation by the Angle brackets.
- Strength class C14 or better,
- Free from wane under the bracket.
- The gap between the timber members does not exceed 3 mm.
- There are no specific requirements relating to preparation of the timber members.

4 Assessment and verification of constancy of performance (AVCP)

4.1 AVCP system

According to the decision 97/638/EC of the European Commission¹, as amended, the system(s) of assessment and verification of constancy of performance (see Annex V to Regulation (EU) No 305/2011) is 2+.

5 Technical details necessary for the implementation of the AVCP system, as foreseen in the applicable EAD

Technical details necessary for the implementation of the AVCP system are laid down in the control plan deposited at ETA-Danmark prior to CE marking.

Issued in Copenhagen on 2017-05-19 by



Thomas Bruun
Managing Director, ETA-Danmark

Annex A
Product details definitions

Table A.1 Materials and Dimensions

Bracket type	Height (mm) vertical	Height (mm) horizontal	Width (mm)	Thickness (mm)	Steel and coating specification
8573 0095 1	95	85	65	4,0	DX 51 D / Z 275 or stainless steel (1.4016, 1.4301, 1.4401, 1.4541, 1.4571)
8573 0135 1	135	85	65	4,0	
8573 0285 1	285	85	65	4,0	
8573 1395 1	95	85	65	4,0	
8573 13135 1	135	85	65	4,0	
8573 13285 1	285	85	65	4,0	
8590 1020 1	100	200	100	2,5	
8591 1060 1	60	100	60	2,5	
8592 6060 1	60	60	100	2,5	
8593 6060 1	60	60	40	2,0	
8594 6060 1	60	60	60	2,0	
8595 8080 1	80	80	100	2,5	
8596 4060 1	40	40	60	2,0	
8597 8080 1	80	80	80	2,0	
8612	60	40	60	2,5	
8613	80	60	60	2,5	
8614	80	80	40	2,0	
8615	100	100	40	2,0	
8616	100	100	60	2,5	
8617	100	60	60	2,5	
8620	54	54	40	2,0	
8621	49	49	35,5	2,5	
8622	69	69	55	2,5	
8622 7070 1FH	68,5	68,5	55	2,0	
8623	92	92	40	3,0	
8624	69	69	55	2,5	
8624 0070 1PLZ	69	69	55	2,0	
8625	89	89	65	2,5	
8625 FH	90	90	65	2,5	
8625 90PL 1Z	90	90	65	2,0	
8626	98	98	90	3,0	
8626 FH	105	105	90	3,0	
8626 10PL 1	105	105	90	2,5	
8627	60	60	45	2,5	
8628	180	150	65	2,5	
8629	77	50	64	2,0	

Bracket type	Height (mm) vertical	Height (mm) horizontal	Width (mm)	Thickness (mm)	Steel and coating specification
8632	89	89	65	2,5	DX 51 D / Z 275 or stainless steel (1.4016, 1.4301, 1.4401, 1.4541, 1.4571)
8632 FH	90	90	65	2,5	
8632 90FH 1Z2.0	90	90	65	2,0	
8633	98	98	90	2,5	
8633 FH	105	105	90	3,0	
8633 10FH 1Z2.0	105	105	90	2,0	
8633 10FH 1Z2.5	105	105	90	2,5	
8634	41	41	60	2,5	
8635	60	60	40	2,5	
8636	59	59	50	2,0	
8637	61	61	60	2,5	
8638	60	60	80	2,5	
8640	80	80	60	2,5	
8641	79,5	79,5	80	2,5	
8644	100	100	80	2,5	
8645	100	100	100	2,5	
8654	90,5	51	80	2,5	
8655	90,5	50,5	50	2,5	

Hold-down	Height (mm) vertical	Height (mm) horizontal	Width (mm)	Thickness (mm)	Steel and coating specification
8791	205	40	40	2,0	DX 51 D / Z 275 or stainless steel (1.4016, 1.4301, 1.4401, 1.4541, 1.4571)
8791 1002 1	100	42	40	2,0	
8792	285	40	40	2,0	
8793	400	40	40	2,0	
8794	500	40	40	2,0	
8795 0090 1FH	90	34	40	2,5	
8795 1603 1	150	53	40	3,0	
8795 1603 1FH	157	50	40	3,0	
8795 2002 1D	200	52	40	2,0	
8795 2002 1E	200	52	40	2,0	
8795 3002 1D	300	52	40	2,0	
8795 3002 1E	300	52	40	2,0	
8795 4002 1D	400	52	40	2,0	
8795 4002 1E	400	52	40	2,0	
8795 5002 1D	500	52	40	2,0	
8795 5002 1E	500	52	40	2,0	
8795 6002 1D	600	52	40	2,0	
8795 6002 1E	600	52	40	2,0	
8799 1603 1D	160	54	40	4,0	
8799 2004 1D	200	54	40	4,0	
8799 2004 1E	200	54	40	4,0	
8799 3004 1D	300	54	40	4,0	
8799 3004 1E	300	54	40	4,0	
8799 4004 1D	400	54	40	4,0	
8799 4004 1E	400	54	40	4,0	
8799 5004 1D	500	54	40	4,0	
8799 5004 1E	500	54	40	4,0	
8799 6004 1D	600	54	40	4,0	
8799 6004 1E	600	54	40	4,0	

Table A.2 Fastener specification

Fastener	Size (mm)			Finish
	Diameter	Length	Profiled length	
Threaded nail according to EN 14592	4,0	40	31	Electroplated zinc or stainless steel
<p>In the load-carrying-capacities of the nailed connection in Annex B the capacities calculated from the formulas of Eurocode 5 are used assuming a thick steel plate when calculating the lateral fastener load-carrying-capacity. The load-carrying-capacities of the angle brackets have been determined based on the use of connector nails \varnothing 4.0 mm in accordance with the German national approval for the nails. The characteristic withdrawal capacity of the nails has to be determined by calculation in accordance with EN 1995-1-1:2010, paragraph 8.3.2 (head pull-through is not relevant):</p> $F_{ax,Rk} = f_{ax,k} \cdot d \cdot t_{pen}$ <p>where:</p> <p>$f_{ax,k}$ Characteristic value of the withdrawal parameter in N/mm²</p> <p>d Nail diameter in mm</p> <p>t_{pen} Penetration depth of the profiled shank including the nail point in mm, $t_{pen} \geq 31$ mm</p> <p>Based on tests by Versuchsanstalt für Stahl, Holz und Steine, Karlsruhe Institute of Technology, the characteristic value of the withdrawal resistance for the threaded nails used can be calculated as:</p> $f_{ax,k} = 50 \cdot 10^{-6} \cdot \rho_k^2$ <p>Where:</p> <p>ρ_k Characteristic density of the timber in kg/m³</p> <p>The shape of the nail or screw directly under the head shall be in the form of a truncated cone with a diameter under the head which fits or exceeds the hole diameter.</p>				
Bolt or Metal Anchor	Diameter		Correspondent Hole diameter	
Bolt according to EN 14592 Anchor according to ETA (see specification of the manufacturer)	10.0 mm, 12.0 mm		Max. 1 mm. larger than the bolt or anchor diameter	

Annex B
Characteristic load-carrying capacities

Angle brackets
Connections timber to timber

Table 1: Force F_1 Column, 2 angle brackets per connection, timber to timber

EAN number	Type	Nail number n_v	Nail number n_h	$F_{1,Rk}$ [kN] (column)	
				Timber	Steel
	8590 1020 1	1,2,3,4,5,6,7,8,9,10	24 ÷ 71	4,26	5,31
	8595 8080 1	1,2,3,4,5	18,19,20,21,22,23,24,25,26,27,28,29,30,31,32,33,34	2,55	5,86
	8597 8080 1	1,2,3,4	15,16,17,18,19,20,21,22,23,24,25,26,27,28	2,53	2,80
	8613	1,2,3	13,14,15,16,18,19,20,21	3,46	2,78
	8614	1,2	7,8,9,10,11,12	1,23	1,21
	8615	1,2,3	8,9,10,11,12,13,14	1,36	1,69
	8616 1060 1	1,2,3,4,5,6	15,16,17,18,19,20,21,22,23,24,25,26,27,28	2,64	3,13
330149	8617	1,2,3,7,8,9	16,17,19,21,23,24	2,37	3,15
330354	8622	1,2	10,11,14,15,17,18	2,23	1,99
	8622 7070 1FH	1,2,6,7	10,11,14,15,17,18	2,25	2,02
330408	8623	1,2,6,7	11,12,14,15,19,20	2,40	1,73
339630	8624	1,2	10,11,14,15,17,18	2,30	2,26
	8624 0070 1PLZ	1,2	10,11,14,15,17,18	2,23	1,32
330453	8625	1,2,10,11	14,15,18,21,25,26	2,00	1,44
	8625 FH	1,2	12,13,14,15,17,18,19,21,22	4,45	2,20
	8625 90PL 1Z	1,2	12,13,14,15,17,18,19,21,22	4,93	1,41
330507	8626	2,3,6,9	16,17,23,24,27,30	2,31	3,90
	8626 FH	1,2,6,7	12,13,14,15,16,17,18,19,20,21,22,23,25,26	6,75	2,60
	8626 10PL 1	1,2,6,7	12,13,14,15,16,17,22,23,27,28	7,47	2,60
330835	8627	1,2	8,9,10,11,13,14	2,13	1,65
	8628	1,2,6,7,11,12	17,18,22,23,26,27,31,32	2,62	7,02
	8629	1,2	9,10,14,15	2,03	3,36
330552	8632	1,2,10,11	14,15,18,21,25,26	2,59	1,40
	8632 FH	1,2	12,13,16,17,18,19,21,22	2,23	9,80
	8632 90FH 1Z2.0	1,2,4,5,6,7,8,9	12,13,16,17,21,22	3,27	6,93
330606	8633	2,3,12,13	16,17,23,24,27,28,29,30	2,59	2,06
	8633 FH	1,2,6,7	12,13,14,15,16,17,18,19,20,21,22,23,25,26	4,50	17,6
	8633 10FH 1Z2.0	1,2,4,5,6,7,8,9	12,13,14,15,20,21,25,26	7,40	13,0
	8633 10FH 1Z2.5	1,2,4,5,6,7,8,9	12,13,14,15,20,21,25,26	7,40	14,3
330705	8635	1,2	7,8,9,10,11,12	2,51	2,55
331481	8636	1,2	9,10,11,12,13,14,15,16	2,52	2,11
330750	8637	1,2,3	10,11,12,13,14,15,16,17,18	3,78	3,81
330804	8638	1,2	11,12, 13, 14,15,16,17,18,19,20	2,52	5,94
331498	8640	1,2,4,5	12, 13, 14,15, 16,17,18,19,20,21,22	2,67	4,24
330859	8641	1,2,5,6	15, 16,17, 18,19,20,21,	2,66	5,94

			22,23,24,25,26,27,28		
332068	8644	1,2,5,6,9,10	19,20,21, 22,23,24,25,26,27, 28,29,30,31,32,33,34,35,36	2,75	5,94
330903	8645	1,2,3,6,7,8	21,22,28,29,30,33,34,35,38,39,40	2,40	3,56
334659	8654	1,2,3	14,15,16,19,20,21	3,20	3,78
334666	8655	1,2,4,5	9,10,12,13	2,12	2,33

Table 2: Force F_1 Column, 1 angle bracket per connection, timber to timber

EAN number	Type	Nail number n_v	Nail number n_h	$F_{1,Rk}$ [kN] (column)	
				Timber	Steel
	8590 1020 1	1,2,3,4,5,6,7,8,9,10	24 ÷ 71	2,13	2,66
	8595 8080 1	1,2,3,4,5	18,19,20,21,22,23,24,25,26,27, 28,29,30,31,32,33,34	1,28	2,93
	8597 8080 1	1,2,3,4	15,16,17,18,19,20,21,22,23,24, 25,26,27,28	1,27	1,40
	8613	1,2,3	13,14,15,16,18,19,20,21	1,73	1,39
	8614	1,2	7,8,9,10,11,12	0,62	0,60
	8615	1,2,3	8,9,10,11,12,13,14	0,68	0,85
	8616 1060 1	1,2,3,4,5,6	15,16,17,18,19,20,21,22,23,24, 25,26,27,28	1,32	1,56
330354	8622	1,2	10,11,14,15,17,18	1,11	0,99
	8622 7070 1FH	1,2	10,11,14,15,17,18	1,12	1,01
	8624 0070 1PLZ	1,2	10,11,14,15,17,18	1,12	0,66
	8625 FH	1,2	12,13,14,15,17,18,19,21,22	2,23	1,10
	8625 90PL 1Z	1,2	12,13,14,15,17,18,19,21,22	2,47	0,70
	8626 FH	1,2,6,7	12,13,14,15,16,17,18,19,20, 21,22,23,25,26	3,38	1,30
	8626 10PL 1	1,2,6,7	12,13,14,15,16,17,22,23,27,28	3,74	1,30
	8628	1,2,6,7,11,12	17,18,22,23,26,27,31,32	1,31	3,51
	8629	1,2	9,10,14,15	1,01	1,68
330552	8632	1,2,10,11	14,15,18,21,25,26	1,29	0,69
	8632 FH	1,2	12,13,16,17,18,19,21,22	1,11	4,90
	8632 90FH 1Z2.0	1,2	12,13,16,17,21,22	1,64	3,42
330606	8633	2,3,12,13	16,17,23,24,27,28,29,30	1,29	1,03
	8633 FH	1,2,6,7	12,13,14,15,16,17,18,19,20, 21,22,23,25,26	2,25	8,82
	8633 10FH 1Z2.0	1,2,6,7	12,13,14,15,20,21,25,26	3,70	6,52
	8633 10FH 1Z2.5	1,2,6,7	12,13,14,15,20,21,25,26	3,70	7,17
334659	8654	1,2,3,	14,15,16,19,20,21	1,60	1,89
334666	8655	1,2,4,5	9,10,12,13	1,06	1,16

Table 3: Force F_1 Purlin, 2 angle brackets per connection, timber to timber

EAN number	Type	Nail number n_v	Nail number n_h	$F_{1,Rk}$ [kN] (purlin)	
				Timber	Steel
	8590 1020 1	1,2,3,4,5,6,7,8,9,10,11,12,13,14,15,16,17,18	24 ÷ 71	4,26	5,31
	8591 1060 1	1,2,3,4,5	9,10,11,12,13,14,15,16,17,18,19,20,21,22	2,64	3,13
	8592 6060 1	1,2,3,4,5,6,7,8	14,15,16,17,18,19,20,21,22,23,24,25,26	3,52	5,31
	8593 6060 1	1,2,3,4	7,8,9,10,11,12	2,29	1,11
	8594 6060 1	1,2,3,4,5,6	10,11,12,13,14,15,16,17,18	3,44	1,67
	8595 8080 1	1,2,3,4,5,6,7,8,9,10,11,12	18,19,20,21,22,23,24,25,26,27,28,29,30,31,32,33,34	2,55	5,86
	8596 4060 1	1,2,3	7,8,9,10,11,12	3,52	2,81
	8597 8080 1	1,2,3,4,5,6,7,8,9,10	15,16,17,18,19,20,21,22,23,24,25,26,27,28	2,53	2,80
	8612	1,2,3,4,6	10,11,12	2,28	2,22
	8613	1,2,3,4,6,7,8	13,14,15,16,18,19,20,21	3,46	2,78
	8614	1,2,3,4,5	7,8,9,10,11,12	1,23	1,21
	8615	1,2,3,4,5,6	8,9,10,11,12,13,14	1,36	1,69
	8616 1060 1	1,2,3,4,5,6,7,8,9,10,11	15,16,17,18,19,20,21,22,23,24,25,26,27,28	2,64	3,13
330149	8617	1,3,5,6,7,9,11,12	16,17,19,21,23,24	2,37	3,15
330255	8620	1,2	5,6,7,8	1,15	1,44
330309	8621	4,5	8,9,13,14	1,92	1,18
330354	8622	1,2,6,7	10,11,14,15,17,18	2,23	1,99
	8622 7070 1FH	1,2,6,7	10,11,14,15,17,18	2,25	2,02
330408	8623	1,2,6,7	11,12,16,17	2,37	1,73
339630	8624	1,2,4,5	10,11,14,15,17,18	2,30	2,26
	8624 0070 1PLZ	1,2,4,5	10,11,14,15,17,18	2,23	1,32
330453	8625	1,2,6,9,12,13	14,15,22,24	2,00	1,44
	8625 FH	1,2,4,5,6,7	12,13,14,15,17,18,19,21,22	4,45	2,20
	8625 90PL 1Z	1,2,4,5,6,7	12,13,14,15,17,18,19,21,22	4,93	1,41
330507	8626	1,4,7,8,14,15	16,17,23,24	2,31	3,89
	8626 FH	1,2,4,5,6,7,8,9	12,13,14,15,16,17,18,19,20,21,22,23,25,26	6,75	2,60
	8626 10PL 1	1,2,4,5,6,7,8,9	12,13,14,15,16,17,22,23,27,28	7,47	2,60
330835	8627	1,2,4,5	8,9,10,11,13,14	2,13	1,65
	8628	1,2,4,5,6,7,8,9,11,12,13,14	17,18,22,23,26,27,31,32	2,62	7,02
	8629	1,2,4,5	9,10,14,15	2,03	3,36
330552	8632	1,2,6,9,12,13	14,15,18,21,25,26	2,59	1,39
	8632 FH	1,2,4,5,6,7,8,9	12,13,16,17,18,19,21,22	2,23	9,80
	8632 90FH 1Z2.0	1,2,4,5,6,7,8,9	12,13,16,17,21,22	3,27	6,83
330606	8633	1,4,6,9,12,13	16,17,18,19,22,25,27,30	2,59	2,06
	8633 FH	1,2,4,5,6,7,8,9	12,13,14,15,16,17,18,19,20,21,22,23,25,26	4,50	17,6
	8633 10FH 1Z2.0	1,2,4,5,6,7,8,9	12,13,14,15,20,21,25,26	7,40	13,0
	8633 10FH 1Z2.5	1,2,4,5,6,7,8,9	12,13,14,15,20,21,25,26	7,40	14,3
330651	8634	1,2,3	7,8,9,10,11,12	3,27	3,81
330705	8635	1,2,3,4	7,8,9,10,11,12	2,51	2,54
331481	8636	1,2,3,4,5	9,10,11,12,13,14,15,16	2,52	2,11
330750	8637	1,2,3,4,5,6	10,11,12,13,14,15,16,17,18	3,77	3,81

330804	8638	1,2,3,4,5,6	11,12,13,14,15,16,17,18,19,20	2,52	5,94
331498	8640	1,2,3,4,5,6,7,8	12,13,14,15,16,17, 18,19,20,21,22	2,66	4,24
330859	8641	1,2,3,4,5,6,7,8,9,10	15,16,17,18,19,20,21,22,23,24, 25,26,27,28	2,66	5,94
332068	8644	1,2,3,4,5,6,7,8,9,10,11, 12,13,14	19,20,21,22,23,24,25,26,27,28, 29,30,31,32,33,34,35,36	2,75	5,94
330903	8645	1,2,3,4,5,6,7,8,9,10,11, 12,13,14,15,16,17,18	21,22,23,24,25,26,27,28,29,30, 31,32,33,34,35,36,37,38,39,40	2,40	3,56
334659	8654	1,3,6,7,12,13	14,15,16,19,20,21	3,20	3,78
334666	8655	1,2,4,5,7,8	9,10,12,13	2,11	2,33

Table 4: Force F_1 Purlin, 1 angle bracket per connection, timber to timber

EAN number	Type	Nail number n_v	Nail number n_h	$F_{1,Rk}$ [kN] (purlin)	
				Timber	Steel
	8590 1020 1	1,2,3,4,5,6,7,8,9,10,11, 12,13,14,15,16,17,18	24 ÷ 71	2,13	2,66
	8591 1060 1	1,2,3,4,5	9,10,11,12,13,14,15,16,17,18,19, 20,21,22	1,32	1,56
	8592 6060 1	1,2,3,4,5,6,7,8	14,15,16,17,18,19,20,21,22, 23,24,25,26	1,76	2,66
	8593 6060 1	1,2,3,4	7,8,9,10,11,12	1,15	0,56
	8594 6060 1	1,2,3,4,5,6	10,11,12,13,14,15,16,17,18	1,72	0,83
	8595 8080 1	1,2,3,4,5,6,7,8,9,10,11, 12	18,19,20,21,22,23,24,25,26, 27,28,29,30,31,32,33,34	1,28	2,93
	8596 4060 1	1,2,3	7,8,9,10,11,12	1,76	1,41
	8597 8080 1	1,2,3,4,5,6,7,8,9,10	15,16,17,18,19,20,21,22,23, 24,25,26,27,28	1,27	1,40
	8612	1,2,3,4,6	10,11,12	1,14	1,11
	8613	1,2,3,4,6,7,8	13,14,15,16,18,19,20,21	1,73	1,39
	8614	1,2,3,4,5	7,8,9,10,11,12	0,62	0,60
	8615	1,2,3,4,5,6	8,9,10,11,12,13,14	0,68	0,85
	8616 1060 1	1,2,3,4,5,6,7,8,9,10,11	15,16,17,18,19,20,21,22,23, 24,25,26,27,28	1,32	1,56
330354	8622	1,2,6,7	10,11,14,15,17,18	1,11	0,99
	8622 7070 1FH	1,2,6,7	10,11,14,15,17,18	1,12	1,01
	8624 0070 1PLZ	1,2,4,5	10,11,14,15,17,18	1,12	0,66
	8625 FH	1,2,4,5,6,7	12,13,14,15,17,18,19,21,22	2,23	1,10
	8625 90PL 1Z	1,2,4,5,6,7	12,13,14,15,17,18,19,21,22	2,47	0,70
	8626 FH	1,2,4,5,6,7,8,9	12,13,14,15,16,17,18,19,20, 21,22,23,25,26	3,38	1,30
	8626 10PL 1	1,2,4,5,6,7,8,9	12,13,14,15,16,17,22,23,27,28	3,74	1,30
	8628	1,2,4,5,6,7,8,9,11,12,13, 14	17,18,22,23,26,27,31,32	1,31	3,51
	8629	1,2,4,5	9,10,14,15	1,01	1,68
330552	8632	1,2,6,9,12,13	14,15,18,21,25,26	1,29	0,69
	8632 FH	1,2,4,5,6,7,8,9	12,13,16,17,18,19,21,22	1,11	4,90
	8632 90FH 1Z2.0	1,2,4,5,6,7,8,9	12,13,16,17,21,22	1,64	3,42
330606	8633	1,4,6,9,12,13	16,17,18,19,22,25,27,30	1,29	1,03
	8633 FH	1,2,4,5,6,7,8,9	12,13,14,15,16,17,18,19,20, 21,22,23,25,26	2,25	8,82
	8633 10FH 1Z2.0	1,2,4,5,6,7,8,9	12,13,14,15,20,21,25,26	3,70	6,52
	8633 10FH 1Z2.5	1,2,4,5,6,7,8,9	12,13,14,15,20,21,25,26	3,70	7,17
334659	8654	1,3,6,7,12,13	14,15,16,19,20,21	1,60	1,89

334666	8655	1,2,4,5,7,8	9,10,12,13	1,05	1,16
--------	------	-------------	------------	------	------

Table 5: Forces $F_{2/3}$, 2 angle brackets per connection, timber to timber

EAN number	Type	Nail number n_v	Nail number n_h	$F_{2/3,Rk}$ [kN]
				Timber
	8590 1020 1	1,2,3,4,5,6,7,8,9,10,11,12,13,14,15,16,17,18	24 ÷ 71	20,0
	8591 1060 1	1,2,3,4,5	9,10,11,12,13,14,15,16,17,18,19,20,21,22	9,31
	8592 6060 1	1,2,3,4,5,6,7,8	14,15,16,17,18,19,20,21,22,23,24,25,26	15,8
	8593 6060 1	1,2,3,4	7,8,9,10,11,12	4,55
	8594 6060 1	1,2,3,4,5,6	10,11,12,13,14,15,16,17,18	7,51
	8595 8080 1	1,2,3,4,5,6,7,8,9,10,11,12	18,19,20,21,22,23,24,25,26,27,28,29,30,31,32,33,34	16,8
	8596 4060 1	1,2,3	7,8,9,10,11,12	6,75
	8597 8080 1	1,2,3,4,5,6,7,8,9,10	15,16,17,18,19,20,21,22,23,24,25,26,27,28	12,5
	8612	1,2,3,4,6	10,11,12	4,40
	8613	1,2,3,4,6,7,8	13,14,15,16,18,19,20,21	7,46
	8614	1,2,3,4,5	7,8,9,10,11,12	4,54
	8615	1,2,3,4,5,6	8,9,10,11,12,13,14	4,97
	8616 1060 1	1,2,3,4,5,6,7,8,9,10,11	15,16,17,18,19,20,21,22,23,24,25,26,27,28	11,1
330149	8617	1,3,5,6,7,9,11,12	16,17,19,21,23,24	6,30
330255	8620	1,2	5,6,7,8	2,22
330309	8621	4,5	8,9,13,14	3,11
330354	8622	1,2,6,7	10,11,14,15,17,18	5,23
	8622 7070 1FH	1,2,6,7	10,11,14,15,17,18	6,01
330408	8623	1,2,6,7	11,12,16,17	3,39
339630	8624	1,2,4,5	10,11,14,15,17,18	4,73
	8624 0070 1PLZ	1,2,4,5	10,11,14,15,17,18	5,83
330453	8625	1,2,6,9,12,13	14,15,22,24	4,20
	8625 FH	1,2,4,5,6,7	12,13,14,15,17,18,19,21,22	6,64
	8625 90PL 1Z	1,2,4,5,6,7	12,13,14,15,17,18,19,21,22	6,88
330507	8626	1,4,7,8,14,15	16,17,23,24	1,99
	8626 FH	1,2,4,5,6,7,8,9	12,13,14,15,16,17,18,19,21,22,23,25,26	10,1
	8626 10PL 1	1,2,4,5,6,7,8,9	12,13,14,15,16,17,22,23,27,28	9,87
330835	8627	1,2,4,5	8,9,10,11,13,14	3,06
	8628	1,2,4,5,6,7,8,9,11,12,13,14	17,18,22,23,26,27,31,32	8,37
	8629	1,2,4,5	9,10,14,15	5,71
330552	8632	1,2,6,9,12,13	14,15,18,21,25,26	4,83
	8632 FH	1,2,4,5,6,7,8,9	12,13,16,17,18,19,21,22	8,18
	8632 90FH 1Z2.0	1,2,4,5,6,7,8,9	12,13,16,17,21,22	6,77
330606	8633	1,4,6,9,12,13	16,17,18,19,22,25,27,30	6,34
	8633 FH	1,2,4,5,6,7,8,9	12,13,14,15,16,17,18,19,20,21,22,23,25,26	7,08
	8633 10FH 1Z2.0	1,2,4,5,6,7,8,9	12,13,14,15,20,21,25,26	9,42
	8633 10FH 1Z2.5	1,2,4,5,6,7,8,9	12,13,14,15,20,21,25,26	9,42
330651	8634	1,2,3	7,8,9,10,11,12	5,34
330705	8635	1,2,3,4	7,8,9,10,11,12	2,85
331481	8636	1,2,3,4,5	9,10,11,12,13,14,15,16	5,86
330750	8637	1,2,3,4,5,6	10,11,12,13,14,15,16,17,18	9,72
330804	8638	1,2,3,4,5,6	11,12,13,14,15,16,17,18,19,20	7,72
331498	8640	1,2,3,4,5,6,7,8	12,13,14,15,16,17,18,19,20,21,22	7,57

330859	8641	1,2,3,4,5,6,7,8,9,10	15,16,17,18,19,20,21,22,23,24,25,26,27,28	10,2
332068	8644	1,2,3,4,5,6,7,8,9,10, 11,12,13,14	19,20,21,22,23,24,25,26,27,28,29, 30,31,32,33,34, 35,36	12,2
330903	8645	1,2,3,4,5,6,7,8,9,10,11, 12,13,14,15,16, 17,18	21,22,23,24,25,26,27,28,29, 30,31,32,33,34,35,36 37,38,39,40	16,0
334659	8654	1,3,6,7,12,13	14,15,16,19,20,21	8,03
334666	8655	1,2,4,5,7,8	9,10,12,13	3,09

Table 6: Forces $F_{2/3}$, 1 angle bracket per connection, timber to timber

EAN number	Type	Nail number n_v	Nail number n_h	$F_{2/3,Rk}$ [kN]
				Timber
	8590 1020 1	1,2,3,4,5,6,7,8,9,10,11, 12,13,14,15,16,17,18	24 ÷ 71	10,0
	8591 1060 1	1,2,3,4,5	9,10,11,12,13,14,15,16,17,18,19,20,21,22	4,65
	8592 6060 1	1,2,3,4,5,6,7,8	14,15,16,17,18,19,20,21,22,23,24,25,26	7,92
	8593 6060 1	1,2,3,4	7,8,9,10,11,12	2,27
	8594 6060 1	1,2,3,4,5,6	10,11,12,13,14,15,16,17,18	3,75
	8595 8080 1	1,2,3,4,5,6,7,8,9,10,11, 12	18,19,20,21,22,23,24,25,26,27,28,29,30, 31,32,33,34	8,38
	8596 4060 1	1,2,3	7,8,9,10,11,12	3,37
	8597 8080 1	1,2,3,4,5,6,7,8,9,10	15,16,17,18,19,20,21,22,23,24,25,26,27,28	6,23
	8612	1,2,3,4,6	10,11,12	2,20
	8613	1,2,3,4,6,7,8	13,14,15,16,18,19,20,21	3,73
	8614	1,2,3,4,5	7,8,9,10,11,12	2,27
	8615	1,2,3,4,5,6	8,9,10,11,12,13,14	2,49
	8616 1060 1	1,2,3,4,5,6,7,8,9,10,11	15,16,17,18,19,20,21,22,23,24,25,26,27,28	5,56
330354	8622	1,2,6,7	10,11,14,15,17,18	2,61
	8622 7070 1FH	1,2,6,7	10,11,14,15,17,18	3,03
	8624 0070 1PLZ	1,2,4,5	10,11,14,15,17,18	2,91
	8625 FH	1,2,4,5,6,7	12,13,14,15,17,18,19,21,22	3,32
	8625 90PL 1Z	1,2,4,5,6,7	12,13,14,15,17,18,19,21,22	3,44
	8626 FH	1,2,4,5,6,7,8,9	12,13,14,15,16,17,18,19,21,22,23,25,26	5,05
	8626 10PL 1	1,2,4,5,6,7,8,9	12,13,14,15,16,17,22,23,27,28	4,94
	8628	1,2,4,5,6,7,8,9,11,12, 13,14	17,18,22,23,26,27,31,32	4,19
	8629	1,2,4,5	9,10,14,15	2,85
330552	8632	1,2,6,9,12,13	14,15,18,21,25,26	2,41
	8632 FH	1,2,4,5,6,7,8,9	12,13,16,17,18,19,21,22	4,09
	8632 90FH 1Z2.0	1,2,4,5,6,7,8,9	12,13,16,17,21,22	3,38
330606	8633	1,4,6,9,12,13	16,17,18,19,22,25,27,30	3,17
	8633 FH	1,2,4,5,6,7,8,9	12,13,14,15,16,17,18,19,20,21,22,23,25,26	3,54
	8633 10FH 1Z2.0	1,2,4,5,6,7,8,9	12,13,14,15,20,21,25,26	4,71
	8633 10FH 1Z2.5	1,2,4,5,6,7,8,9	12,13,14,15,20,21,25,26	4,71
334659	8654	1,3,6,7,12,13	14,15,16,19,20,21	4,01
334666	8655	1,2,4,5,7,8	9,10,12,13	1,54

Table 7: Basic Forces $F_{4/5}$, 2 angle brackets per connection, timber to timber

EAN number	Type	Nail number n_v	Nail number n_h	$F_{4/5,Rk}$ [kN]	
				Timber	Steel
	8590 1020 1	1,2,3,4,5,6,7,8,9,10,11,12,13,14,15,16,17,18	24 ÷ 71	9,89	5,01
	8591 1060 1	1,2,3,4,5	9,10,11,12,13,14,15,16,17,18,19,20,21,22	6,53	3,43
	8592 6060 1	1,2,3,4,5,6,7,8	14,15,16,17,18,19,20,21,22,23,24,25,26	8,79	5,82
	8593 6060 1	1,2,3,4	7,8,9,10,11,12	4,08	1,84
	8594 6060 1	1,2,3,4,5,6	10,11,12,13,14,15,16,17,18	6,02	2,77
	8595 8080 1	1,2,3,4,5,6,7,8,9,10,11,12	18,19,20,21,22,23,24,25,26,27,28,29,30,31,32,33,34	9,59	6,03
	8596 4060 1	1,2,3	7,8,9,10,11,12	5,26	2,19
	8597 8080 1	1,2,3,4,5,6,7,8,9,10	15,16,17,18,19,20,21,22,23,24,25,26,27,28	7,06	3,56
	8612	1,2,3,4,6	10,11,12	5,64	3,69
	8613	1,2,3,4,6,7,8	13,14,15,16,18,19,20,21	6,44	3,63
	8614	1,2,3,4,5	7,8,9,10,11,12	5,98	1,82
	8615	1,2,3,4,5,6	8,9,10,11,12,13,14	6,02	1,81
	8616 1060 1	1,2,3,4,5,6,7,8,9,10,11	15,16,17,18,19,20,21,22,23,24,25,26,27,28	7,59	3,63
330149	8617	1,3,5,6,7,9,11,12	16,17,19,21,23,24	6,38	3,63
330255	8620	1,2	5,6,7,8	3,85	1,38
330309	8621	4,5	8,9,13,14	5,36	3,85
330354	8622	1,2,6,7	10,11,14,15,17,18	5,15	3,69
	8622 7070 1FH	1,2,6,7	10,11,14,15,17,18	5,30	3,34
330408	8623	1,2,6,7	11,12,16,17	5,42	3,90
339630	8624	1,2,4,5	10,11,14,15,17,18	4,73	3,68
	8624 0070 1PLZ	1,2,4,5	10,11,14,15,17,18	5,13	2,50
330453	8625	1,2,6,9,12,13	14,15,22,24	5,15	4,07
	8625 FH	1,2,4,5,6,7	12,13,14,15,17,18,19,21,22	8,67	3,83
	8625 90PL 1Z	1,2,4,5,6,7	12,13,14,15,17,18,19,21,22	5,71	2,77
330507	8626	1,4,7,8,14,15	16,17,23,24	10,3	10,6
	8626 FH	1,2,4,5,6,7,8,9	12,13,14,15,16,17,18,19,21,22,23,25,26	8,05	5,56
	8626 10PL 1	1,2,4,5,6,7,8,9	12,13,14,15,16,17,22,23,27,28	8,38	5,43
330835	8627	1,2,4,5	8,9,10,11,13,14	5,28	2,66
	8628	1,2,4,5,6,7,8,9,11,12,13,14	17,18,22,23,26,27,31,32	13,8	6,51
	8629	1,2,4,5	9,10,14,15	5,96	3,26
330552	8632	1,2,6,9,12,13	14,15,18,21,25,26	6,11	7,70
	8632 FH	1,2,4,5,6,7,8,9	12,13,16,17,18,19,21,22	7,68	6,56
	8632 90FH 1Z2.0	1,2,4,5,6,7,8,9	12,13,16,17,21,22	7,58	5,37
330606	8633	1,4,6,9,12,13	16,17,18,19,22,25,27,30	6,70	9,32

	8633 FH	1,2,4,5,6,7,8,9	12,13,14,15,16,17,18,19,20,21,22,23,25,26	11,2	9,48
	8633 10FH 1Z2.0	1,2,4,5,6,7,8,9	12,13,14,15,20,21,25,26	10,4	6,95
	8633 10FH 1Z2.5	1,2,4,5,6,7,8,9	12,13,14,15,20,21,25,26	10,5	8,87
330651	8634	1,2,3	7,8,9,10,11,12	8,76	3,27
330705	8635	1,2,3,4	7,8,9,10,11,12	4,84	2,39
331481	8636	1,2,3,4,5	9,10,11,12,13,14,15,16	5,90	2,18
330750	8637	1,2,3,4,5,6	10,11,12,13,14,15,16,17,18	7,26	3,58
330804	8638	1,2,3,4,5,6	11,12,13, 14,15,16,17,18,19,20	7,81	4,44
331498	8640	1,2,3,4,5,6,7,8	12,13,14,15,16,17,18,19,20,21,22	7,18	2,89
330859	8641	1,2,3,4,5,6,7,8,9,10	15,16,17,18,19,20,21,22,23,24,25,26,27,28	8,75	4,73
332068	8644	1,2,3,4,5,6,7,8,9,10,11,12,13,14	19,20,21,22,23,24,25,26,27,28,29,30,31,32,33,34,35,36	9,66	4,67
330903	8645	1,2,3,4,5,6,7,8,9,10,11,12,13,14,15,16,17,18	21,22,23,24,25,26,27,28,29,30,31,32,33,34,35,36,37,38,39,40	13,1	5,97
334659	8654	1,3,6,7,12,13	14,15,16,19,20,21	5,39	6,93
334666	8655	1,2,4,5,7,8	9,10,12,13	4,82	4,12

Table 8: Basic Forces F_4 1 angle bracket per connection, timber to timber

EAN number	Type	Nail number n_v	Nail number n_h	$F_{4,Rk}$ [kN]	
				Timber	Steel
330354	8622	1,2,6,7	10,11,14,15,17,18	7,53	2,71
	8622 7070 1FH	1,2,6,7	10,11,14,15,17,18	5,43	2,45
	8625 FH	1,2,4,5,6,7	12,13,14,15,17,18,19,21,22	5,74	3,35
	8626 FH	1,2,4,5,6,7,8,9	12,13,14,15,16,17,18,19,21,22,23,25,26	7,10	4,90
	8628	1,2,4,5,6,7,8,9,11,12,13,14	17,18,22,23,26,27,31,32	12,8	4,81
	8629	1,2,4,5	9,10,14,15	6,48	2,92
330552	8632	1,2,6,9,12,13	14,15,18,21,25,26	7,38	5,34
	8632 FH	1,2,4,5,6,7,8,9	12,13,16,17,18,19,21,22	7,68	4,78
	8632 90FH 1Z2.0	1,2,4,5,6,7,8,9	12,13,16,17,21,22	8,64	3,77
330606	8633	1,4,6,9,12,13	16,17,18,19,22,25,27,30	10,0	6,53
	8633 FH	1,2,4,5,6,7,8,9	12,13,14,15,16,17,18,19,20,21,22,23,25,26	11,19	7,48
	8633 10FH 1Z2.0	1,2,4,5,6,7,8,9	12,13,14,15,20,21,25,26	11,6	5,44
	8633 10FH 1Z2.5	1,2,4,5,6,7,8,9	12,13,14,15,20,21,25,26	11,9	6,87
334659	8654	1,3,6,7,12,13	14,15,16,19,20,21	4,92	4,69
334666	8655	1,2,4,5,7,8	9,10,12,13	4,84	3,77

Table 9: Basic Forces F_5 , 1 angle bracket per connection, timber to timber

EAN number	Type	Nail number n_v	Nail number n_h	$F_{5,Rk}$ [kN]	
				Timber	Steel
330354	8622	1,2,6,7	10,11,14,15,17,18	1,34	1,11
	8622 7070 1FH	1,2,6,7	10,11,14,15,17,18	1,40	1,01
	8625 FH	1,2,4,5,6,7	12,13,14,15,17,18,19,21,22	1,07	0,83
	8626 FH	1,2,4,5,6,7,8,9	12,13,14,15,16,17,18,19,21,22,23,25,26	1,29	1,19
	8628	1,2,4,5,6,7,8,9,11,12,13,14	17,18,22,23,26,27,31,32	2,09	1,98
	8629	-	-	-	-
330552	8632	1,2,6,9,12,13	14,15,18,21,25,26	1,81	2,38
	8632 FH	1,2,4,5,6,7,8,9	12,13,16,17,18,19,21,22	2,31	1,97
	8632 90FH 1Z2.0	1,2,4,5,6,7,8,9	12,13,16,17,21,22	2,27	1,73
330606	8633	1,4,6,9,12,13	16,17,18,19,22,25,27,30	1,72	2,94
	8633 FH	1,2,4,5,6,7,8,9	12,13,14,15,16,17,18,19,20,21,22,23,25,26	2,36	2,56
	8633 10FH 1Z2.0	1,2,4,5,6,7,8,9	12,13,14,15,20,21,25,26	2,28	1,86
	8633 10FH 1Z2.5	1,2,4,5,6,7,8,9	12,13,14,15,20,21,25,26	2,35	2,41
334659	8654	1,3,6,7,12,13	14,15,16,19,20,21	1,52	2,18
334666	8655	1,2,4,5,7,8	9,10,12,13	1,47	1,34

Angle brackets**Connections timber to concrete or timber to steel****Table 10:** Force F_1 Column, 2 angle brackets per connection, connection timber to concrete/steel

EAN number	Type	Nail number n_v	Bolt number n_h	$F_{1,Rk}$ [kN] (column)		bolt $k_{t,II}$
				Timber	Steel	
	8573 0095 1	11,12,13	4	9,43	8,39	0,95
	8573 0135 1	11,12,13,17,18,19	4	18,9	8,39	0,95
	8573 0285 1	11,12,13,15,16,17,18,19,21,22,23,24,25,26,27,28,29,30,32,33	4	62,8	8,39	0,95
	8573 1395 1	11,12,13	4	9,43	14,3	0,74
	8573 13135 1	11,12,13,17,18,19	4	18,90	14,3	0,74
	8573 13285 1	11,12,13,15,16,17,18,19,21,22,23,24,25,26,27,28,29,30,32,33	4	62,80	14,3	0,74
	8613	1,2,3	17	9,65	1,17	1,3
330149	8617	1,2,3,7,8,9	20	19,3	1,22	1,3
330354	8622	1,2	16	6,43	0,80	2,5
	8622 7070 1FH	1,2	16	6,48	0,52	2,4
330408	8623	1,2,6,7	13	12,8	1,36	0,8
339630	8624	1,2	16	6,43	0,80	2,5
	8624 0070 1PLZ	1,2	16	6,48	0,51	2,5
	8625 FH	1,2	16	6,43	1,72	0,8
	8625 90PL 1Z	1,2	16	6,48	1,10	0,8
	8626 FH	1,2,6,7	24	12,8	1,14	3,3
	8626 10PL 1	22,23,27,28	10,11	12,90	3,13	0,7
330835	8627	1,2	12	6,43	0,79	2,0
	8628	22,23,26,27,31,32	10	19,3	0,44	1,1
	8629	1,2	13	6,48	0,71	1,6
	8632 FH	1,2	20	6,43	0,61	5,7
	8632 90FH 1Z2.0	1,2	14,15	6,48	2,42	0,41
	8633 FH	1,2,6,7	24	12,8	1,14	3,3
	8633 10FH 1Z2.0	20,21,25,26	10,11	12,90	10,60	0,33
	8633 10FH 1Z2.5	20,21,25,26	10,11	12,90	11,90	0,33
334659	8654	1,2,3	17 or 18	9,65	1,45	2,9
334666	8655	1,2,4,5	11	12,9	0,98	3,3

Table 11: Force F_1 Column, 1 angle bracket per connection, connection timber to concrete/steel

EAN number	Type	Nail number n_v	Bolt number n_h	$F_{1,Rk}$ [kN] (column)		bolt $k_{t,II}$
				Timber	Steel	
	8573 0095 1	11,12,13	4	4,71	4,20	1,90
	8573 0135 1	11,12,13,17,18,19	4	9,43	4,20	1,90
	8573 0285 1	11,12,13,15,16,17,18,19,21,22,23,24,25,26,27,28,29,30,32,33	4	31,40	4,20	1,90
	8573 1395 1	11,12,13	4	4,71	7,16	1,48
	8573 13135 1	11,12,13,17,18,19	4	9,43	7,16	1,48
	8573 13285 1	11,12,13,15,16,17,18,19,21,22,23,24,25,26,27,28,29,30,32,33	4	31,40	7,16	1,48
330354	8622	1,2	16	3,22	0,40	4,9
	8622 7070 1FH	1,2	16	3,24	0,26	4,9
	8624 0070 1PLZ	1,2	16	3,24	0,26	4,9
	8625 90PL 1Z	1,2	16	3,24	0,55	1,6
	8626 10PL 1	22,23,27,28	10,11	6,43	1,56	1,3
	8628	22,23,26,27,31,32	10	9,65	0,22	2,1
	8629	1,2	13	3,24	0,36	3,1
	8632 FH	1,2	20	3,22	0,30	11,3
	8632 90FH 1Z2.0	1,2	14,15	3,24	1,21	0,83
	8633 FH	1,2,6,7	24	6,38	0,57	6,7
	8633 10FH 1Z2.0	20,21,25,26	10,11	6,43	5,28	0,67
	8633 10FH 1Z2.5	20,21,25,26	10,11	6,43	5,95	0,67
334659	8654	1,2,3	17 or 18	4,83	0,73	5,8
334666	8655	1,2,4,5	11	6,43	0,49	6,5

Table 12: Force F_1 Purlin, 2 angle brackets per connection, connection timber to concrete/steel

EAN number	Type	Nail number n_v	Bolt number n_h	$F_{1,Rk}$ [kN] (purlin)		bolt $k_{t,II}$
				Timber	Steel	
	8573 0095 1	5,6,7,8,9,10,11,12,13	4	25,1	8,39	0,95
	8573 0135 1	5,6,7,8,9,10,11,12,13,15,16,17,18,19	4	44,0	8,39	0,95
	8573 0285 1	5,6,7,8,9,10,11,12,13,14,15,16,17,18,19,21,22,23,32,33	4	62,8	8,39	0,95
	8573 1395 1	5,6,7,8,9,10,11,12,13	4	25,1	14,3	0,74
	8573 13135 1	5,6,7,8,9,10,11,12,13,15,16,17,18,19	4	44,0	14,3	0,74
	8573 13285 1	5,6,7,8,9,10,11,12,13,15,16,17,18,19,21,22,23,24,25,26,27,28,29,30,32,33	4	62,8	14,3	0,74
	8612	1,2,3,4,6	13	16,1	1,76	2,5
	8613	1,2,3,4,5,7,8	17	22,5	1,17	1,3
330149	8617	1,3,5,6,7,9,11,12	20	25,7	1,22	1,3
	8621	4,5	12	6,43	0,72	1,9
330354	8622	1,2,6,7	16	12,9	0,80	2,5
	8622 7070 1FH	1,2,6,7	16	13,0	0,52	2,4
330408	8623	1,2,6,7	13	12,8	1,36	0,8
339630	8624	1,2,4,5	16	12,9	0,80	2,5

	8624 0070 1PLZ	1,2,4,5	16	13,0	0,51	2,5
	8625 FH	1,2,4,5,6,7	16	19,3	1,72	0,8
	8625 90PL 1Z	1,2,4,5,6,7	16	19,5	1,10	0,8
	8626 FH	1,2,4,5,6,7,8,9	24	25,5	1,14	3,3
	8626 10PL 1	18,19,20,21,22,23,24,26,27,28	10,11	25,7	3,13	0,7
330835	8627	1,2,4,5	12	12,9	0,79	2,0
	8628	19,20,22,23,24,25,26,27,28,29,31,32	10	38,6	0,44	1,1
	8629	1,2,4,5	13	13,0	0,71	1,6
	8632 FH	1,2,4,5,6,7,8,9	20	25,7	0,61	5,7
	8632 90FH 1Z2.0	1,2,4,5,6,7,8,9	14,15	25,9	2,42	0,41
	8633 FH	1,2,4,5,6,7,8,9	24	25,5	1,14	3,3
	8633 10FH 1Z2.0	18,19,20,21,22,23,25,26	10,11	25,7	10,6	0,33
	8633 10FH 1Z2.5	18,19,20,21,22,23,25,26	10,11	25,7	11,9	0,33
334659	8654	1,3,6,7,12,13	17 or 18	19,3	1,45	2,9
334666	8655	1,2,4,5,7,8	11	19,3	0,98	3,3

Table 13: Force F_1 Purlin, 1 angle bracket per connection, connection timber to concrete/steel

EAN number	Type	Nail number n_v	Bolt number n_h	$F_{1,Rk}$ [kN] (purlin)		bolt $k_{t,II}$
				Timber	Steel	
	8573 0095 1	5,6,7,8,9,10,11,12,13	4	12,6	4,20	1,90
	8573 0135 1	5,6,7,8,9,10,11,12,13,15,16,17,18,19	4	22,0	4,20	1,90
	8573 0285 1	5,6,7,8,9,10,11,12,13,14,15,16,17,18,19,21,22,23,32,33	4	31,4	4,20	1,90
	8573 1395 1	5,6,7,8,9,10,11,12,13	4	12,6	7,16	1,48
	8573 13135 1	5,6,7,8,9,10,11,12,13,15,16,17,18,19	4	22,0	7,16	1,48
	8573 13285 1	5,6,7,8,9,10,11,12,13,15,16,17,18,19,21,22,23,24,25,26,27,28,29,30,32,33	4	31,4	7,16	1,48
330354	8622	1,2,6,7	16	6,43	0,40	4,9
	8622 7070 1FH	1,2,6,7	16	6,48	0,26	4,9
	8624 0070 1PLZ	1,2,4,5	16	6,48	0,26	4,9
	8625 90PL 1Z	1,2,4,5,6,7	16	9,73	0,55	1,6
	8626 10PL 1	18,19,20,21,22,23,24,26,27,28	10,11	12,9	1,56	1,3
	8628	19,20,22,23,24,25,26,27,28,29,31,32	10	19,3	0,22	2,1
	8629	1,2,4,5	13	6,48	0,36	3,1
	8632 FH	1,2,4,5,6,7,8,9	20	12,9	0,30	11,3
	8632 90FH 1Z2.0	1,2,4,5,6,7,8,9	14,15	13,00	1,21	0,83
	8633 FH	1,2,4,5,6,7,8,9	24	12,8	0,57	6,7
	8633 10FH 1Z2.0	18,19,20,21,22,23,25,26	10,11	12,9	5,28	0,67
	8633 10FH 1Z2.5	18,19,20,21,22,23,25,26	10,11	12,9	5,95	0,67
334659	8654	1,3,6,7,12,13	17 or 18	9,65	0,73	5,8
334666	8655	1,2,4,5,7,8	11	9,65	0,49	6,5

Table 14: Forces $F_{2/3}$, 2 angle brackets per connection, connection timber to concrete/steel

EAN number	Type	Nail number n_v	Bolt number n_h	$F_{2/3,Rk}$ [kN]	bolt
				Timber	$k_{t,\perp}$
	8573 0095 1	5,6,7,8,9,10,11,12,13	4	3,11	0,5
	8573 0135 1	5,6,7,8,9,10,11,12,13,15,16,17,18,19	4	5,13	0,5
	8573 0285 1	5,6,7,8,9,10,11,12,13,14,15,16,17,18,19,21,22,23,32,33	4	9,90	0,5
	8573 1395 1	5,6,7,8,9,10,11,12,13	4	3,86	0,5
	8573 13135 1	5,6,7,8,9,10,11,12,13,15,16,17,18,19	4	6,43	0,5
	8573 13285 1	5,6,7,8,9,10,11,12,13,15,16,17,18,19,21,22,23,24,25,26,27,28,29,30,32,33	4	12,0	0,5
	8612	1,2,3,4,6	13	3,11	0,5
	8613	1,2,3,4,5,7,8	17	3,01	0,5
330149	8617	1,3,5,6,7,9,11,12	20	4,04	0,5
	8621	4,5	12	1,02	0,5
	8622 7070 1FH	1,2,6,7	16	1,57	0,5
330408	8623	1,2,6,7	13	1,97	0,5
339630	8624	1,2,4,5	16	1,90	0,5
	8624 0070 1PLZ	1,2,4,5	16	1,90	0,5
	8625 FH	1,2,4,5,6,7	16	3,70	0,5
	8625 90PL 1Z	1,2,4,5,6,7	16	3,71	0,5
	8626 FH	1,2,4,5,6,7,8,9	24	3,11	0,5
	8626 10PL 1	18,19,20,21,22,23,24,26,27,28	10,11	10,5	0,3
330835	8627	1,2,4,5	12	1,61	0,5
330354	8622	1,2,6,7	16	1,56	0,5
	8628	19,20,22,23,24,25,26,27,28,29,31,32	10	3,29	0,5
	8632 FH	1,2,4,5,6,7,8,9	20	2,78	0,5
	8632 90FH 1Z2.0	1,2,4,5,6,7,8,9	14,15	8,09	0,5
	8633 FH	1,2,4,5,6,7,8,9	24	3,11	0,5
	8633 10FH 1Z2.0	18,19,20,21,22,23,25,26	10,11	7,58	0,4
	8633 10FH 1Z2.5	18,19,20,21,22,23,25,26	10,11	7,58	0,4
334659	8654	1,3,6,7,12,13	17 or 18	5,04	0,5
334666	8655	1,2,4,5,7,8	11	2,78	0,5

Table 15: Forces $F_{2/3}$, 1 angle bracket per connection, connection timber to concrete/steel

EAN number	Type	Nail number n_v	Bolt number n_h	$F_{2/3,Rk}$ [kN]	bolt
				Timber	$k_{t,\perp}$
	8573 0095 1	5,6,7,8,9,10,11,12,13	4	1,55	1,0
	8573 0135 1	5,6,7,8,9,10,11,12,13,15,16,17,18,19	4	2,57	1,0
	8573 0285 1	5,6,7,8,9,10,11,12,13,14,15,16,17,18,19,21,22,23,32,33	4	4,95	1,0
	8573 1395 1	5,6,7,8,9,10,11,12,13	4	1,93	1,0
	8573 13135 1	5,6,7,8,9,10,11,12,13,15,16,17,18,19	4	3,21	1,0
	8573 13285 1	5,6,7,8,9,10,11,12,13,15,16,17,18,19,21,22,23,24,25,26,27,28,29,30,32,33	4	5,99	1,0
330354	8622	1,2,6,7	16	0,78	1,0
	8622 7070 1FH	1,2,6,7	16	0,79	1,0
	8624 0070 1PLZ	1,2,4,5	16	0,95	1,0
	8625 90PL 1Z	1,2,4,5,6,7	16	1,85	1,0
	8626 10PL 1	18,19,20,21,22,23,24,26,27,28	10,11	5,26	0,7
	8628	19,20,22,23,24,25,26,27,28,29,31,32	10	1,64	1,0

	8632 FH	1,2,4,5,6,7,8,9	20	1,39	1,0
	8632 90FH 1Z2.0	1,2,4,5,6,7,8,9	14,15	4,04	0,9
	8633 FH	1,2,4,5,6,7,8,9	24	1,55	1,0
	8633 10FH 1Z2.0	18,19,20,21,22,23,25,26	10,11	3,79	0,7
	8633 10FH 1Z2.5	18,19,20,21,22,23,25,26	10,11	3,79	0,7
334659	8654	1,3,6,7,12,13	17 or 18	2,52	1,0
334666	8655	1,2,4,5,7,8	11	1,39	1,0

Table 16: Basic Forces $F_{4/5}$, 2 angle brackets per connection, connection timber to concrete/steel

EAN number	Type	Nail number n_v	Bolt number n_h	$F_{4/5,Rk}$ [kN]		bolt	
				Timber	Steel	$k_{t,\perp}$	$k_{t,\parallel}$
	8573 1395 1	5,6,7,8,9,10,11,12,13	4	8,88	8,64	0,77	0,38
	8573 13135 1	5,6,7,8,9,10,11,12,13,15,16,17,18,19	4	12,1	9,15	0,74	0,33
	8573 13285 1	5,6,7,8,9,10,11,12,13,15,16,17,18,19,21,22,23,24,25,26,27,28,29,30,32,33	4	9,53	8,69	0,74	0,32
	8612	1,2,3,4,6	13	6,57	3,36	0,8	0,2
	8613	1,2,3,4,5,7,8	17	6,01	3,51	0,8	0,2
330149	8617	1,3,5,6,7,9,11,12	20	6,52	3,47	0,8	0,2
	8621	4,5	12	4,14	1,82	0,7	0,2
330354	8622	1,2,6,7	16	5,33	3,63	0,7	0,2
	8622 7070 1FH	1,2,6,7	16	5,45	3,25	0,73	0,49
330408	8623	1,2,6,7	13	5,66	2,88	0,8	0,1
339630	8624	1,2,4,5	16	6,13	3,09	0,8	0,1
	8624 0070 1PLZ	1,2,4,5	16	5,24	2,33	0,8	0,1
	8625 FH	1,2,4,5,6,7	16	7,17	3,54	0,9	0,2
	8625 90PL 1Z	1,2,4,5,6,7	16	5,99	-	0,9	0,1
	8626 FH	1,2,4,5,6,7,8,9	24	9,10	6,59	0,8	0,1
	8626 10PL 1	18,19,20,21,22,23,24,26,27,28	10,11	7,85	5,50	0,8	0,2
330835	8627	1,2,4,5	12	5,26	2,59	0,8	0,2
	8628	19,20,22,23,24,25,26,27,28,29,31,32	10	8,38	5,86	0,7	0,2
	8629	1,2,4,5	13	7,04	4,00	0,8	0,2
	8632 FH	1,2,4,5,6,7,8,9	20	8,42	5,64	0,7	0,2
	8632 90FH 1Z2.0	1,2,4,5,6,7,8,9	14,15	8,81	4,88	0,35	0,18
	8633 FH	1,2,4,5,6,7,8,9	24	10,2	9,41	0,4	0,2
	8633 10FH 1Z2.0	18,19,20,21,22,23,25,26	10,11	13,0	5,83	0,41	0,20
	8633 10FH 1Z2.5	18,19,20,21,22,23,25,26	10,11	13,0	7,34	0,41	0,20
334659	8654	1,3,6,7,12,13	17 or 18	6,20	5,83	0,7	0,2
334666	8655	1,2,4,5,7,8	11	5,43	3,70	0,7	0,2

Table 17: Basic Forces F_4 1 angle bracket per connection, connection timber to concrete/steel

EAN number	Type	Nail number n_v	Bolt number n_h	$F_{4,Rk}$ [kN]		bolt
				Timber	Steel	$k_{t,\perp}$
	8573 1395 1	5,6,7,8,9,10,11,12	4	9,28	6,63	1,00
	8573 13135 1	5,6,7,8,9,10,11,12,13,15,16,17,18,19	4	9,91	6,80	1,00

	8573 13285 1	5,6,7,8,9,10,11,12,13,15,16,17,18,19,21,22,23,24,25,26,27,28,29,30,32,33	4	13,7	6,44	1,00
330354	8622	1,2,6,7	16	5,61	2,67	1,0
	8622 7070 1FH	1,2,6,7	16	5,75	2,38	1,00
	8628	19,20,22,23,24,25,26,27,28,29,31,32	10	9,88	4,35	1,0
	8629	1,2,4,5	13	6,32	3,25	1,0
	8632 FH	1,2,4,5,6,7,8,9	20	9,77	4,60	1,0
	8632 90 FH 1Z2.0	1,2,4,5,6,7,8,9	14,15	9,21	3,42	0,50
	8633 FH	1,2,4,5,6,7,8,9	24	13,0	6,92	1,0
	8633 10FH 1Z2.0	1,2,4,5,6,7,8,9	10,11	12,5	4,76	0,50
	8633 10FH 1Z2.5	1,2,4,5,6,7,8,9	10,11	12,7	5,98	0,50
334659	8654	1,3,6,7,12,13	17 or 18	8,16	4,35	1,0
334666	8655	1,2,4,5,7,8	11	5,84	2,64	1,0

Table 18: Basic Forces F_5 , 1 angle bracket per connection, connection timber to concrete/steel

EAN number	Type	Nail number n_v	Bolt number n_h	$F_{5,Rk}$ [kN]		bolt	
				Timber	Steel	$k_{t,\perp}$	$k_{t,\parallel}$
	8573 1395 1	5,6,7,8,9,10,11,12,13	4	2,07	4,03	1,00	1,63
	8573 13135 1	5,6,7,8,9,10,11,12,13,15,16,17,18,19	4	2,39	3,34	1,00	1,28
	8573 13285 1	5,6,7,8,9,10,11,12,13,15,16,17,18,19,21,22,23,24,25,26,27,28,29,30,32,33	4	2,47	3,65	1,00	1,25
330354	8622	1,2,6,7	16	1,40	1,06	1,0	0,6
	8622 7070 1FH	1,2,6,7	16	1,45	0,92	1,00	0,73
	8628	19,20,22,23,24,25,26,27,28,29,31,32	10	2,16	1,64	1,0	0,7
	8629	1,2,4,5	13	1,32	0,91	1,0	1,2
	8632 FH	1,2,4,5,6,7,8,9	20	2,59	1,73	1,0	0,5
	8632 90 FH 1Z2.0	1,2,4,5,6,7,8,9	14,15	2,62	1,54	0,50	0,60
	8633 FH	1,2,4,5,6,7,8,9	24	2,72	2,52	1,0	0,7
	8633 10FH 1Z2.0	1,2,4,5,6,7,8,9	10,11	2,40	1,86	0,50	1,11
	8633 10FH 1Z2.5	1,2,4,5,6,7,8,9	10,11	2,40	2,47	0,50	1,09
334659	8654	1,3,6,7,12,13	17 or 18	1,72	1,62	1,0	0,8
334666	8655	1,2,4,5,7,8	11	1,61	1,10	1,0	0,7

Hold-Downs**Connections timber to concrete****Table 19:** Force F_1 Column, 1 hold-down per connection, timber to concrete, softwood¹⁾ $\rho_k = 350 \text{ kg/m}^3$

Type	Timber	Concrete	Steel				Bolt
	capacity per nail in the vertical flange ³⁾ $F_{v,Rk}$ [kN]		moment capacity $F_{m,Rk}$ [kN]		shear capacity $F_{c,Rk}$ [kN]	tensile capacity $F_{t,Rk}$ [kN]	factor $k_{t,II}$
			With base plate ²⁾	With washer according to EN ISO 7091			
8791	n · 1,62	see EN1992	-	-	-	17,8	-
8791 1002 1	n · 1,62		15,1	1,23	11,5	15,7	2,67
8792	n · 1,62		-	-	-	17,8	-
8793	n · 1,62		-	-	-	17,8	-
8794	n · 1,62		-	-	-	17,8	-
8795 0090 1FH	n · 1,61		20,2	1,72	14,4	23,0	2,67
8795 1603 1	n · 1,60		9,38	1,24	17,3	24,1	2,87
8795 1603 1FH	n · 1,60		10,5	1,33	17,3	24,1	2,86
8795 2002 1D	n · 1,62		9,20	0,59	11,5	17,8	2,80
8795 2002 1E	n · 1,62		9,20	0,67	11,5	17,8	2,80
8795 3002 1D	n · 1,62		9,20	0,59	11,5	17,8	2,80
8795 3002 1E	n · 1,62		9,20	0,67	11,5	17,8	2,80
8795 4002 1D	n · 1,62		9,20	0,59	11,5	17,8	2,80
8795 4002 1E	n · 1,62		9,20	0,67	11,5	17,8	2,80
8795 5002 1D	n · 1,62		9,20	0,59	11,5	17,8	2,80
8795 5002 1E	n · 1,62		9,20	0,67	11,5	17,8	2,80
8795 6002 1D	n · 1,62		9,20	0,59	11,5	17,8	2,80
8795 6002 1E	n · 1,62		9,20	0,67	11,5	17,8	2,80
8799 1603 1D	n · 1,60		8,91	1,16	17,3	24,1	2,93
8799 2004 1D	n · 1,57		9,78	2,06	23,1	35,6	2,93
8799 2004 1E	n · 1,57		9,78	2,29	23,1	35,6	2,93
8799 3004 1D	n · 1,57		9,78	2,06	23,1	35,6	2,93
8799 3004 1E	n · 1,57		9,78	2,29	23,1	35,6	2,93
8799 4004 1D	n · 1,57		9,78	2,06	23,1	35,6	2,93
8799 4004 1E	n · 1,57		9,78	2,29	23,1	35,6	2,93
8799 5004 1D	n · 1,57		9,78	2,06	23,1	35,6	2,93
8799 5004 1E	n · 1,57		9,78	2,29	23,1	35,6	2,93
8799 6004 1D	n · 1,57		9,78	2,06	23,1	35,6	2,93
8799 6004 1E	n · 1,57		9,78	2,29	23,1	35,6	2,93

¹⁾ For other characteristic softwood densities, $F_{v,Rk}$ is multiplied by $k_{dens} = \left(\frac{\rho_k}{350}\right)^{0,5}$

For hardwoods, $F_{v,Rk}$ is calculated according to EN 1995-1-1

²⁾ Base plates according to the engineering drawings must be used

³⁾ If a wood-based panel interlayer with a thickness of not more than 26 mm is placed between the connector plate and the timber member, the lateral load-carrying capacity of the nail has to take into account the effect of the interlayer.

Table 20: Force F_1 Column, 1 hold-down per connection, timber to timber, softwood¹⁾ $\rho_k = 350 \text{ kg/m}^3$

Type	Timber	Steel		Bolt
	capacity per nail in the vertical flange ³⁾ $F_{v,Rk}$ [kN]	moment capacity $F_{m,Rk}$ [kN]		factor $k_{t,II}$
		With base plate ²⁾	With washer according to EN ISO 7091	
8791 1002 1	(n-1)·1,62	0,91	0,91	1,0
8795 0090 1FH	(n-1)·1,61	1,84	1,84	
8795 1603 1	(n-1)·1,60	1,18	1,18	
8795 1603 1FH	(n-1)·1,60	1,32	1,32	
8795 2002 1D	(n-1)·1,62	0,56	0,56	
8795 2002 1E	(n-1)·1,62	0,56	0,56	
8795 3002 1D	(n-1)·1,62	0,56	0,56	
8795 3002 1E	(n-1)·1,62	0,56	0,56	
8795 4002 1D	(n-1)·1,62	0,56	0,56	
8795 4002 1E	(n-1)·1,62	0,56	0,56	
8795 5002 1D	(n-1)·1,62	0,56	0,56	
8795 5002 1E	(n-1)·1,62	0,56	0,56	
8795 6002 1D	(n-1)·1,62	0,56	0,56	
8795 6002 1E	(n-1)·1,62	0,56	0,56	
8799 1603 1D	(n-1)·1,60	1,13	1,13	
8799 2004 1D	(n-1)·1,57	2,00	2,00	
8799 2004 1E	(n-1)·1,57	2,00	2,00	
8799 3004 1D	(n-1)·1,57	2,00	2,00	
8799 3004 1E	(n-1)·1,57	2,00	2,00	
8799 4004 1D	(n-1)·1,57	2,00	2,00	
8799 4004 1E	(n-1)·1,57	2,00	2,00	
8799 5004 1D	(n-1)·1,57	2,00	2,00	
8799 5004 1E	(n-1)·1,57	2,00	2,00	
8799 6004 1D	(n-1)·1,57	2,00	2,00	
8799 6004 1E	(n-1)·1,57	2,00	2,00	

¹⁾ For other characteristic softwood densities, $F_{v,Rk}$ is multiplied by $k_{dens} = \left(\frac{\rho_k}{350}\right)^{0,5}$

For hardwoods, $F_{v,Rk}$ is calculated according to EN 1995-1-1

²⁾ Base plates according to the engineering drawings must be used

³⁾ If a wood-based panel interlayer with a thickness of not more than 26 mm is placed between the connector plate and the timber member, the lateral load-carrying capacity of the nail has to take into account the effect of the interlayer.

Definitions of forces, their directions and eccentricity

Forces - Beam to beam connection

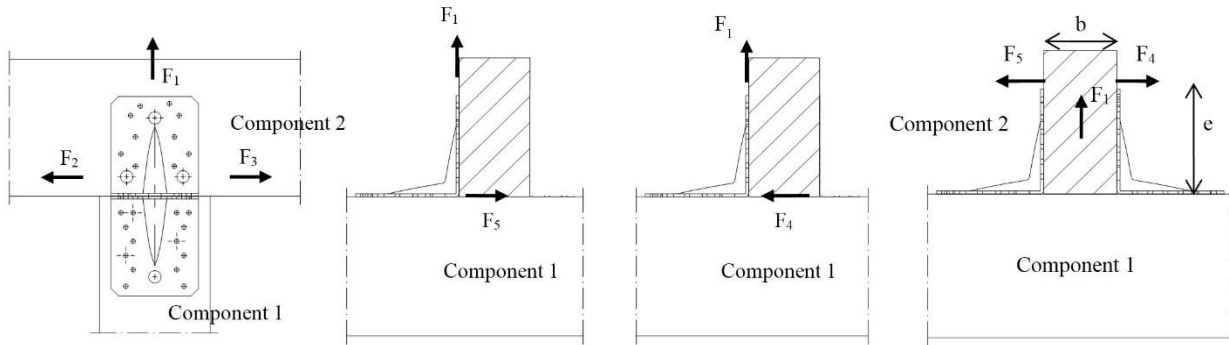

Fastener specification

Holes are marked with numbers referring to the nailing pattern in Annex B.

Acting forces

- F_1 Lifting force acting in the central axis of the joint. The components shall be prevented from rotation.
- F_2 and F_3 Lateral force acting in the joint between the component 2 and the component 1 in the component 2 direction. The components shall be prevented from rotation.
- F_4 and F_5 Lateral force acting in the component 1 direction along the central axis of the joint. The components shall be prevented from rotation.
Only for double angle brackets per connection: The load may be applied with an eccentricity e , then a design for combined loading is required.

Double angle brackets per connection

The angle brackets must be placed at each side opposite each other, symmetric to the component axis.

Wane

Wane is not allowed, the timber has to be sharp-edged in the area of the angle brackets.

Timber splitting

For the lifting force F_1 it must be checked in accordance with Eurocode 5 or a similar national Timber Code that splitting will not occur.

Combined forces

If the forces F_1 and F_2/F_3 or F_4/F_5 act at the same time, the following inequality shall be fulfilled:

$$\left(\frac{F_{1,Ed}}{F_{1,Rd}} \right)^2 + \left(\frac{F_{2,Ed}}{F_{2,Rd}} \right)^2 + \left(\frac{F_{3,Ed}}{F_{3,Rd}} \right)^2 + \left(\frac{F_{4,Ed}}{F_{4,Rd}} \right)^2 + \left(\frac{F_{5,Ed}}{F_{5,Rd}} \right)^2 \leq 1$$

The forces F_2 and F_3 or F_4 and F_5 are forces with opposite direction. Therefore only one force F_2 or F_3 , respectively, and F_4 or F_5 , respectively, is able to act simultaneously with F_1 , while the other shall be set to zero.

If the load $F_{4/5}$ is applied with an eccentricity e , a design for combined loading **for connections with double angle brackets** is required. Here, an additional force $\Delta F_{1,Ed}$ has to be added to the existing force $F_{1,Ed}$.

$$\Delta F_{1,Ed} = F_{4/5,Ed} \cdot \frac{e}{b}$$

b is the width of component 2.

Connection of timber to concrete or steel with bolts or metal anchors

The load $F_{B,Ed}$ for the design of the maximally loaded bolt or metal anchor is calculated as:

$$F_{B,t,Ed} = k_{t,\parallel} \cdot F_{Ed}$$

$$F_{B,v,Ed} = k_{t,\perp} \cdot F_{Ed}$$

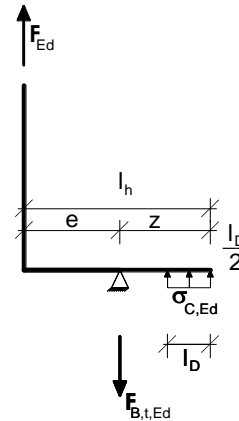

where:

- $F_{B,t,Ed}$ Resulting tensile load on the maximally loaded bolt in the group in N
- $F_{B,v,Ed}$ Resulting shear load on the maximally loaded bolt in the group in N
- $k_{t,\parallel}$ Coefficient taking into account the resulting axial force
- $k_{t,\perp}$ Coefficient taking into account the moment arm or hole tolerance, respectively
- F_{Ed} Load on vertical flap of the angle bracket or pair of angle brackets in N
- $\sigma_{C,Ed}$ compressive stress on the support in N/mm^2
- l_D Length of the section under compressive stress in mm (usually 10 mm)

GAH Angle Brackets

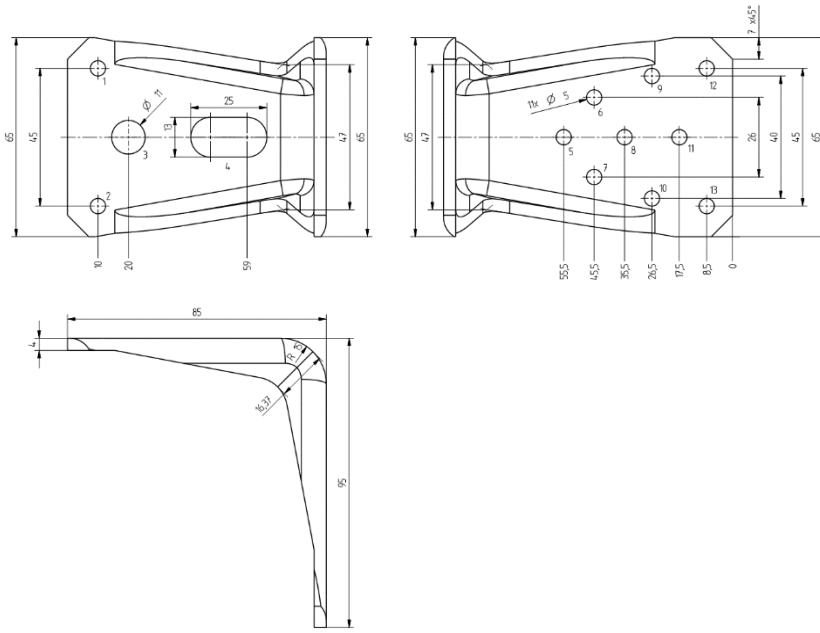

Figure A.1 Angle Bracket 8573 0095 1

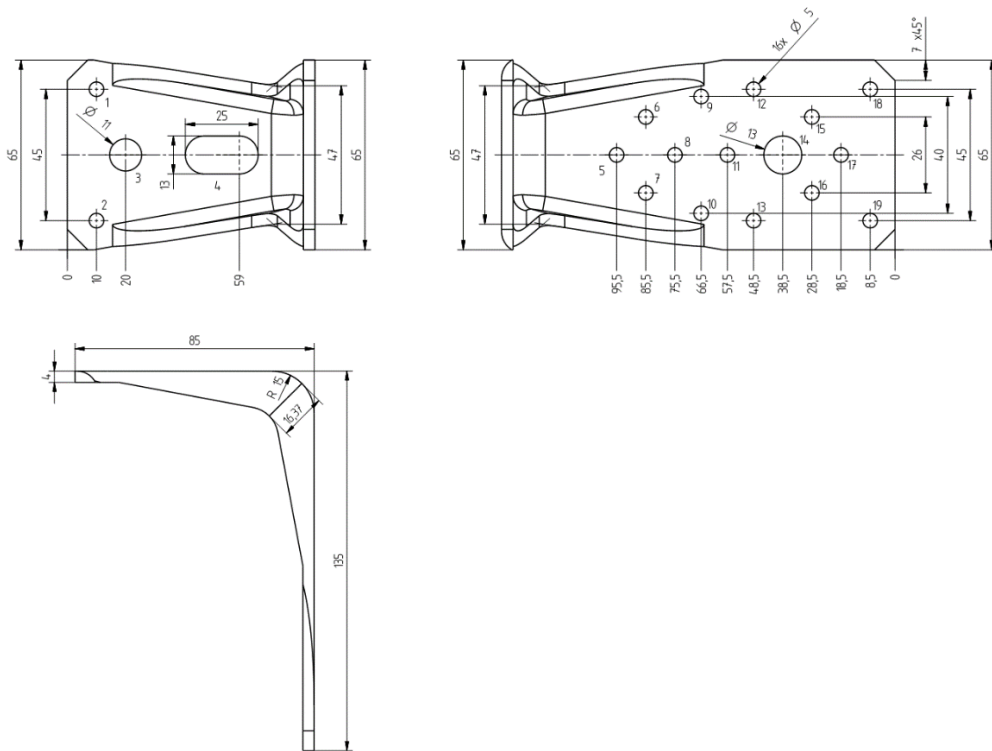

Figure A.2 Angle Bracket 8573 0135 1

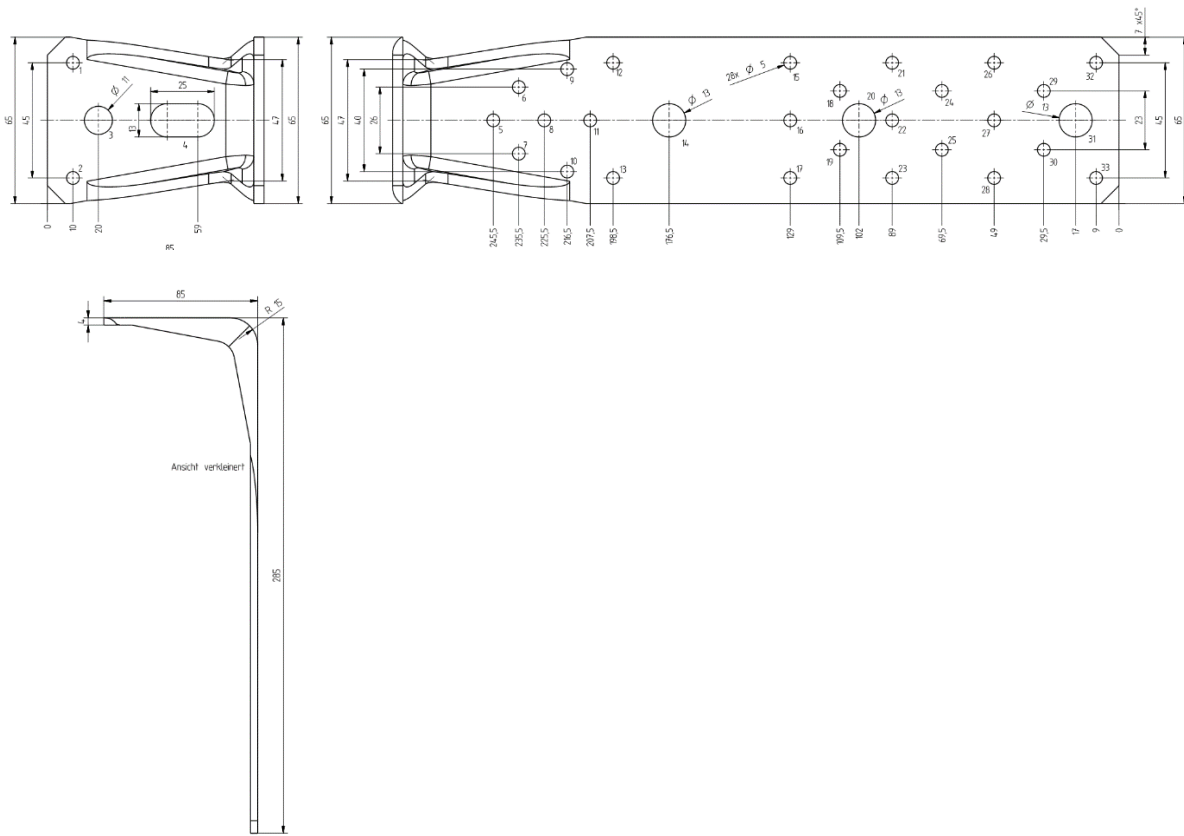

Figure A.3 Angle Bracket 8573 0285 1

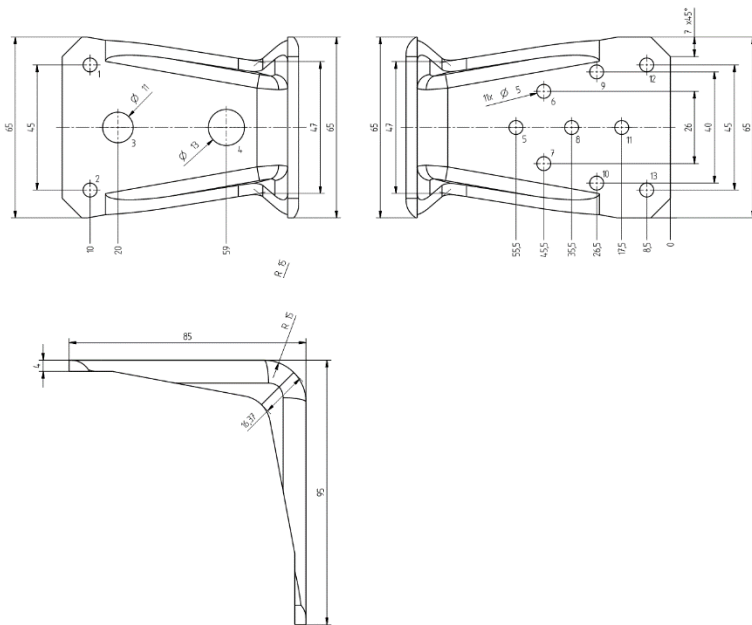

Figure A.4 Angle Bracket 8573 1395 1

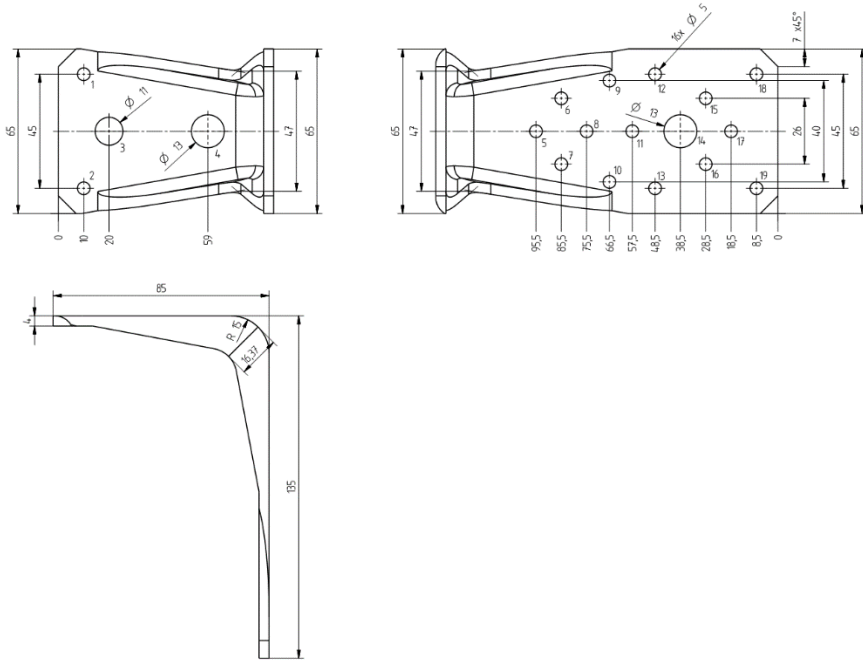

Figure A.5 Angle Bracket 8573 13135 1

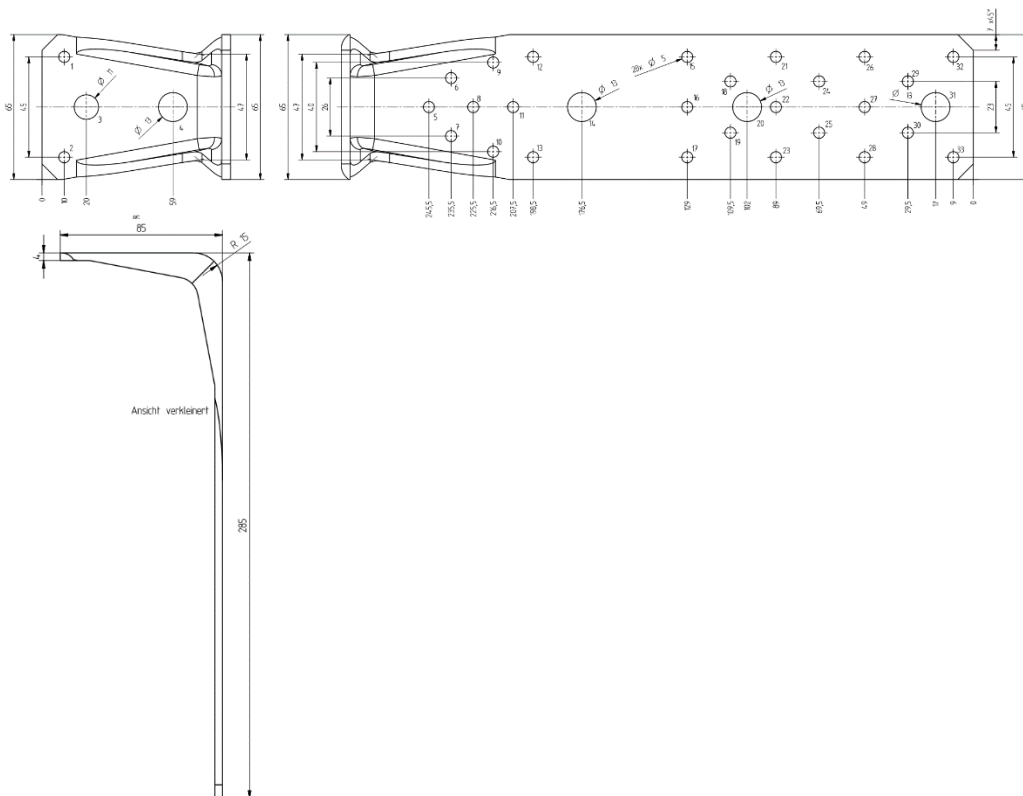

Figure A.6 Angle Bracket 8573 13285 1

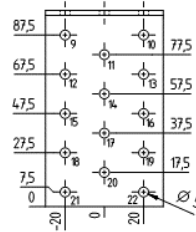
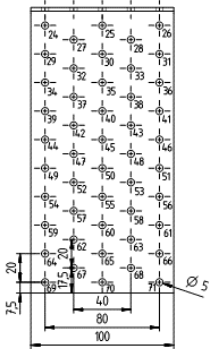
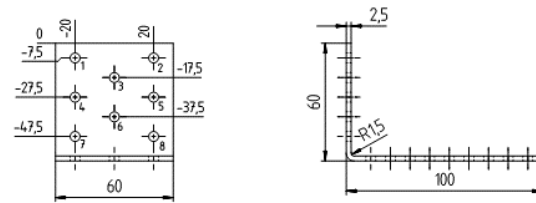
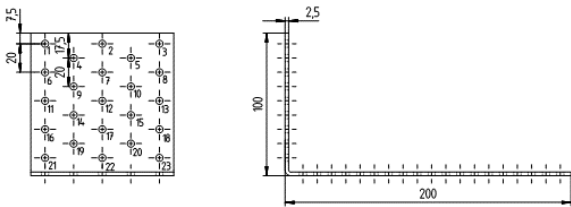

Figure A.7 Angle Bracket 8590 1020 1

Figure A.8 Angle Bracket 8591 1060 1

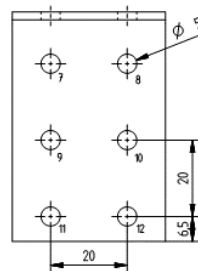
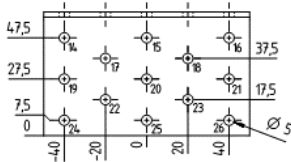
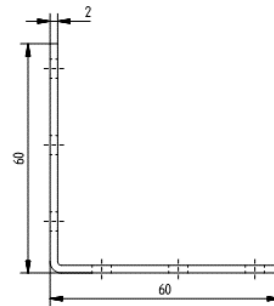
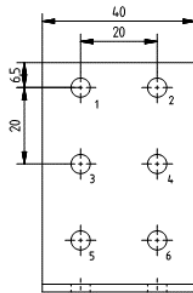
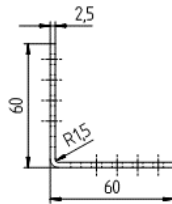
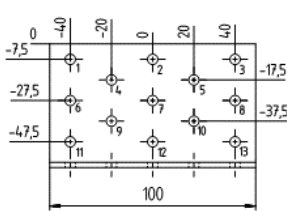

Figure A.9 Angle Bracket 8592 6060 1

Figure A.10 Angle Bracket 8593 6060 1

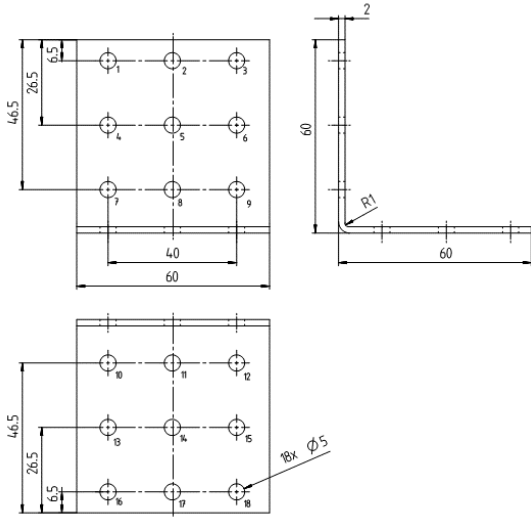

Figure A.11 Angle Bracket 8594 6060 1

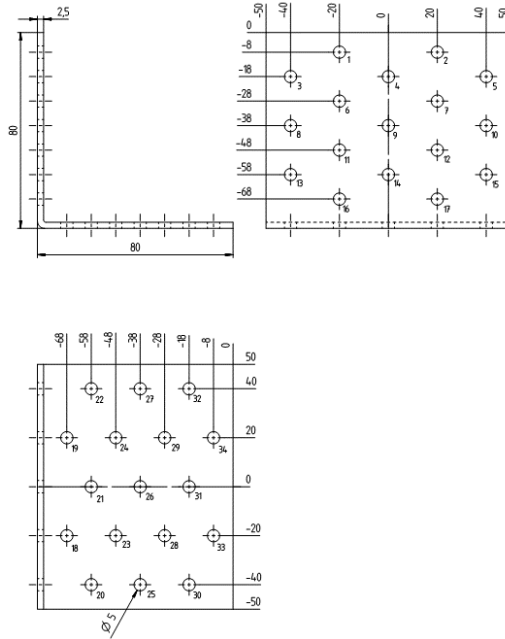

Figure A.12 Angle Bracket 8595 8080 1

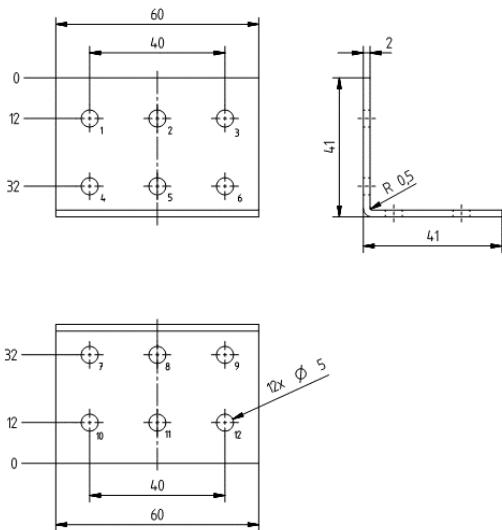

Figure A.13 Angle Bracket 8596 4060 1

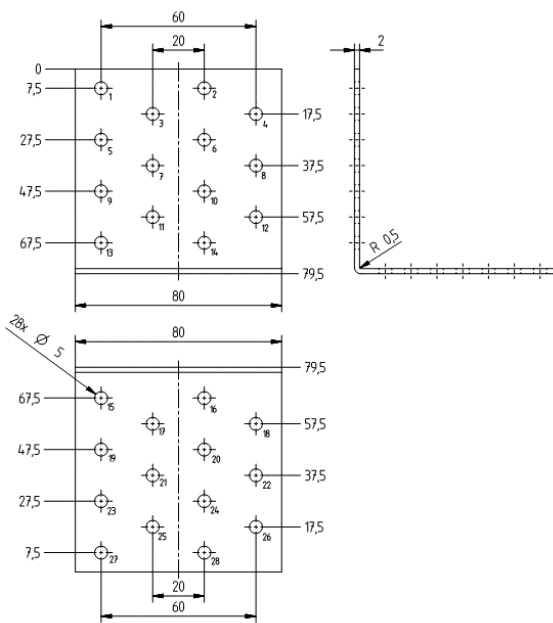

Figure A.14 Angle Bracket 8597 8080 1

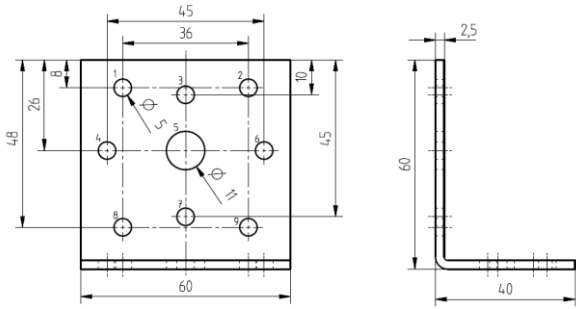

Figure A.15 Angle Bracket 8612

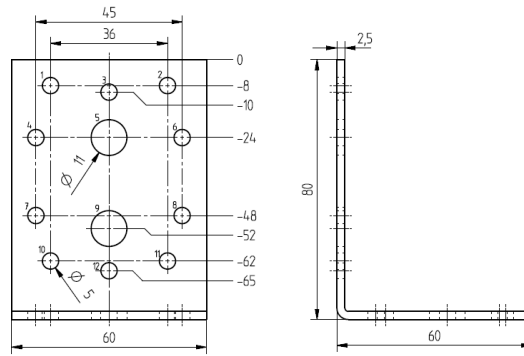

Figure A.16 Angle Bracket 8613

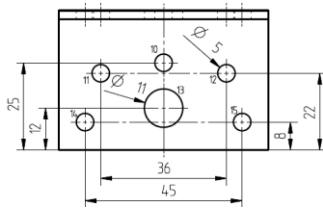

Figure A.17 Angle Bracket 8614

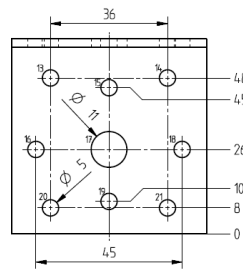
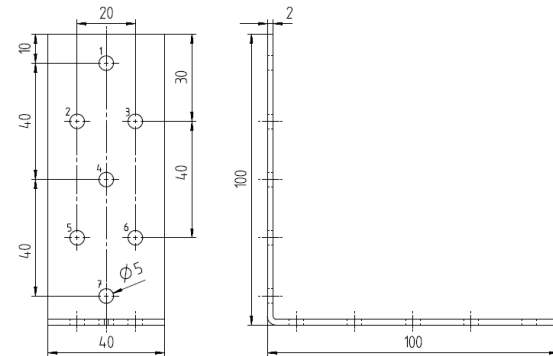
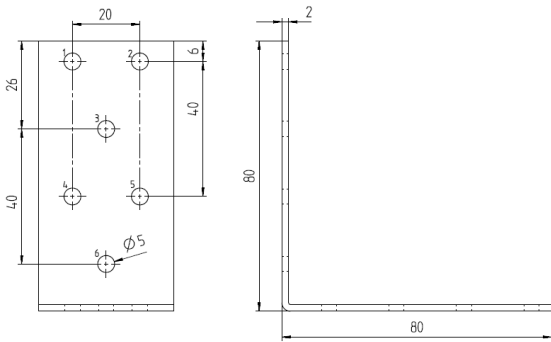

Figure A.18 Angle Bracket 8615



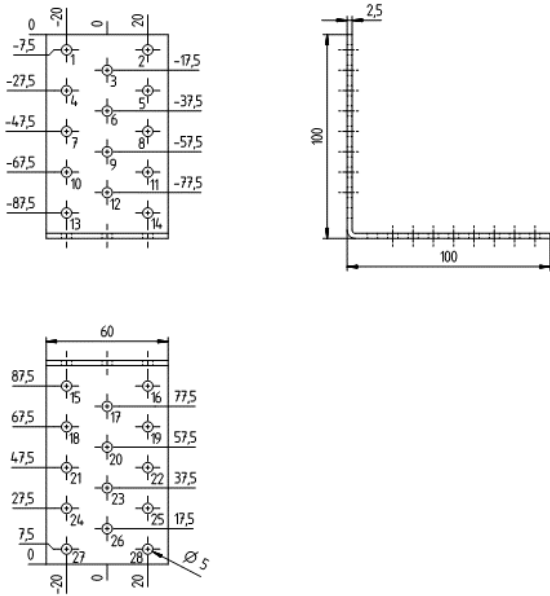

Figure A.19 Angle Bracket 8616

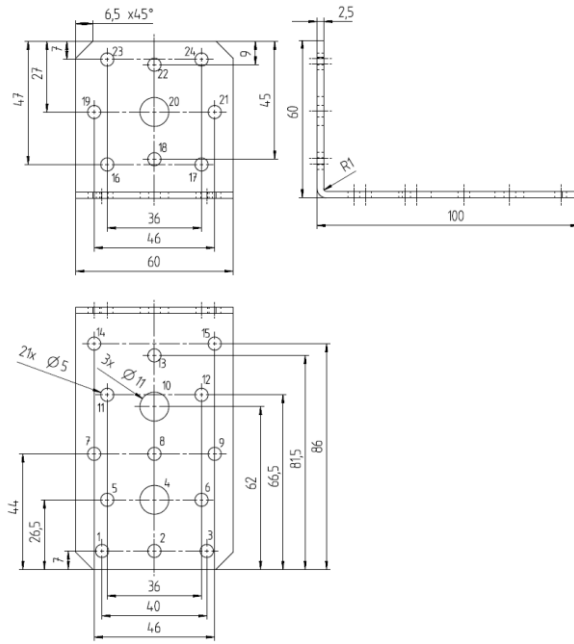

Figure A.20 Angle Bracket 8617

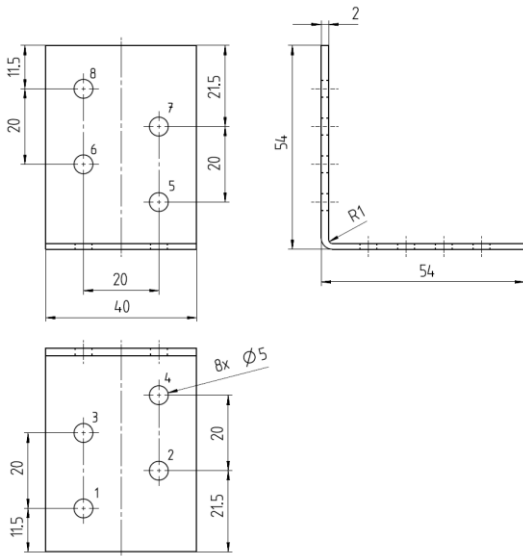

Figure A.21 Angle Bracket 8620

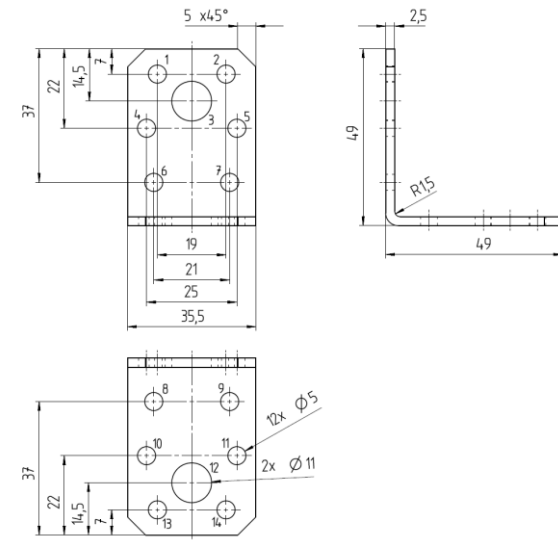

Figure A.22 Angle Bracket 8621

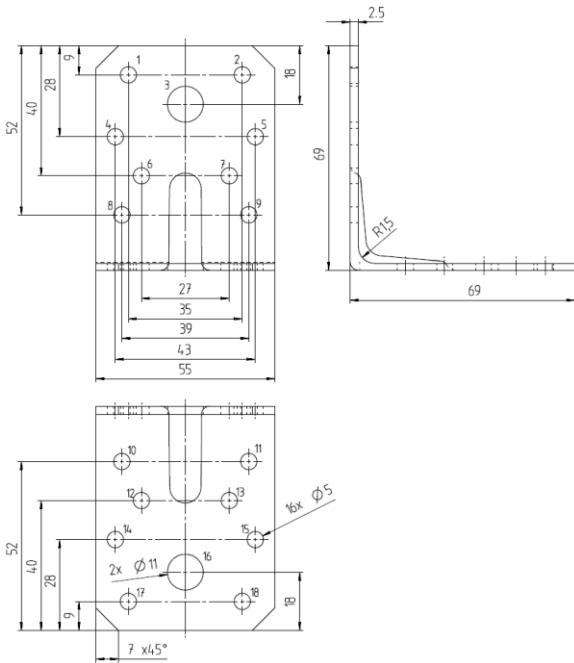

Figure A.23 Angle Bracket 8622

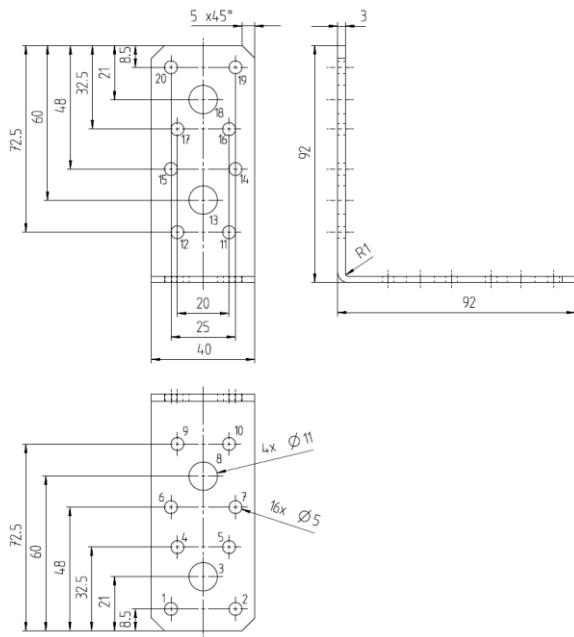

Figure A.24 Angle Bracket 8623

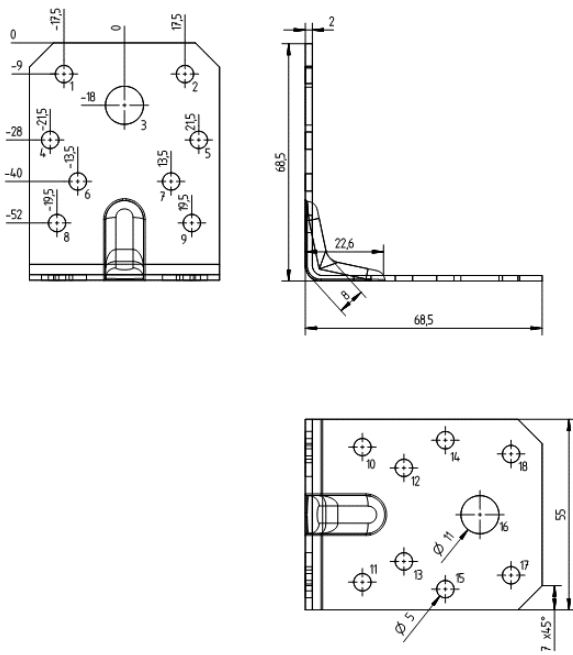

Figure A.25 Angle Bracket 8622 70 70 1FH

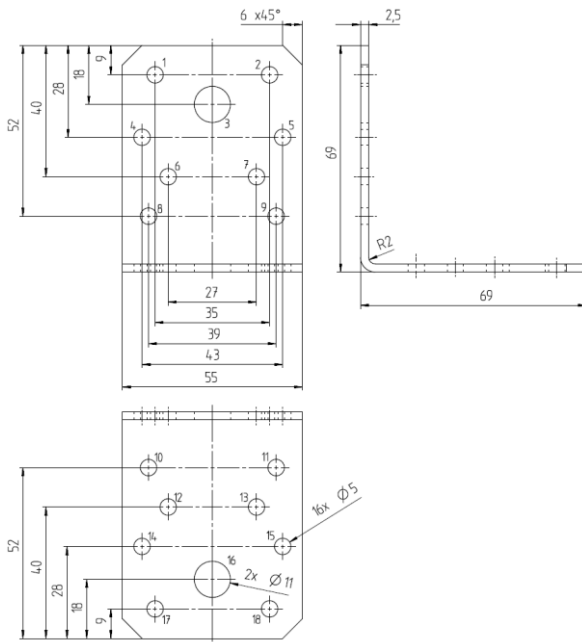

Figure A.26 Angle Bracket 8624

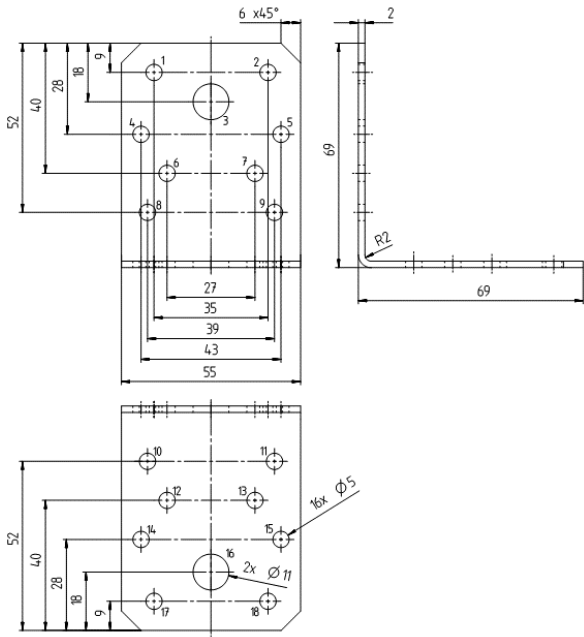

Figure A.27 Angle Bracket 8624 0070 1PLZ

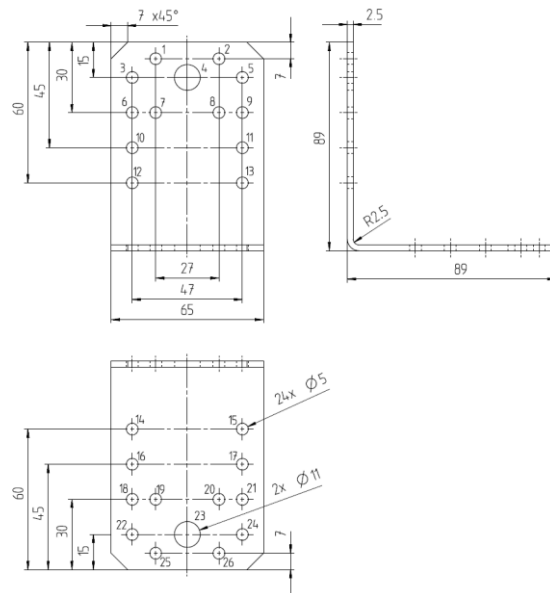

Figure A.28 Angle Bracket 8625

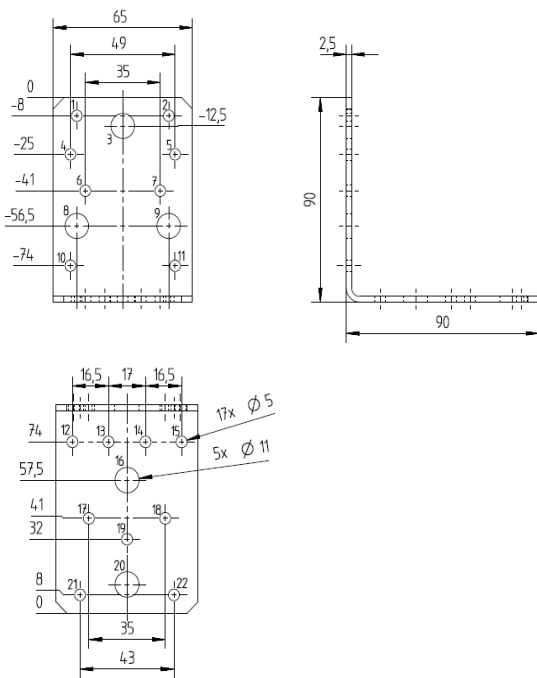

Figure A.29 Angle Bracket 8625 FH

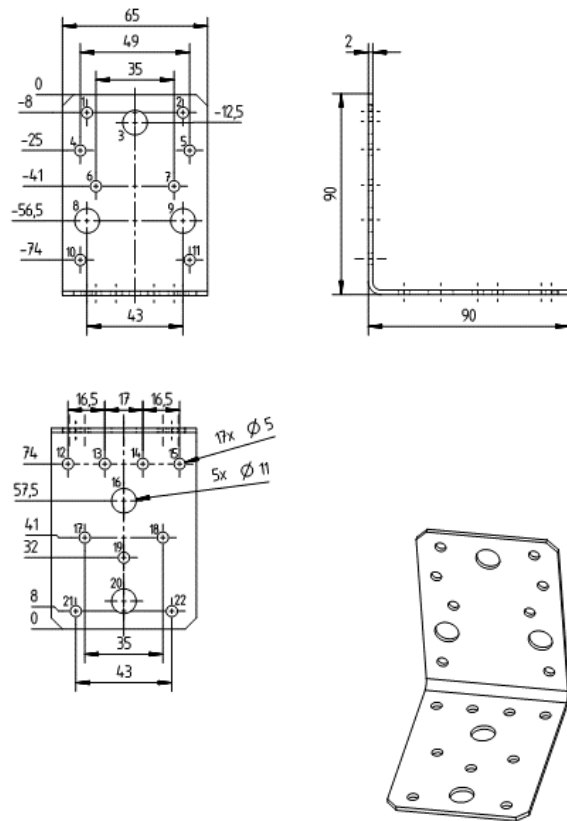

Figure A.30 Angle Bracket 8625 90PL 1Z

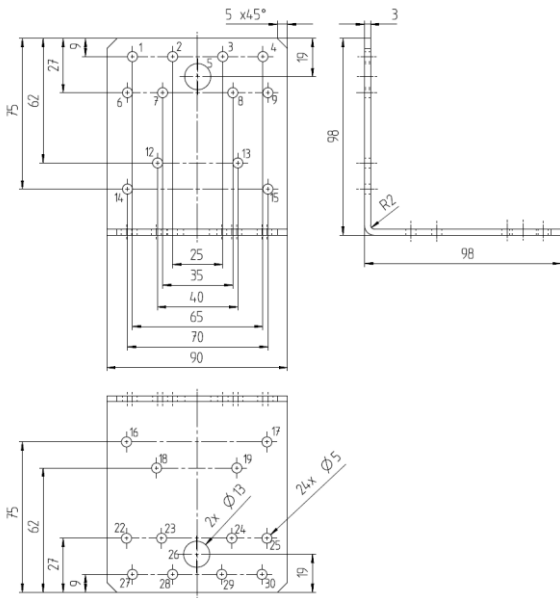

Figure A.31 Angle Bracket 8626

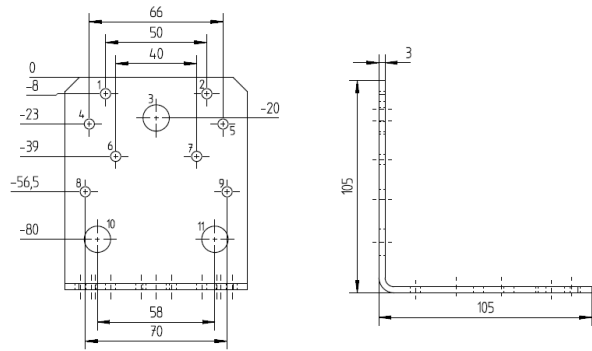

Figure A.32 Angle Bracket 8626 FH

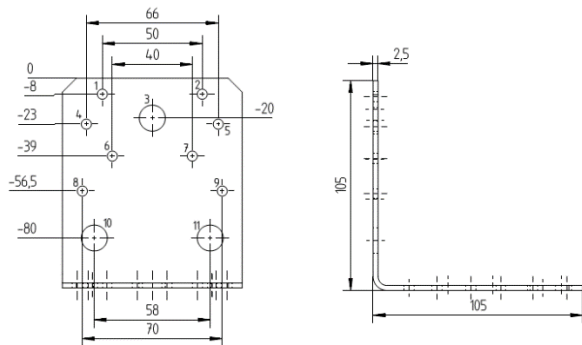
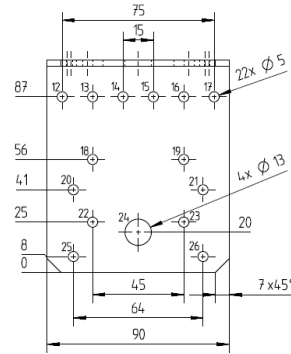
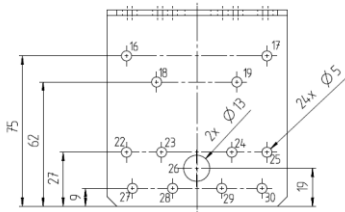

Figure A.33 Angle Bracket 8626 10PL 1

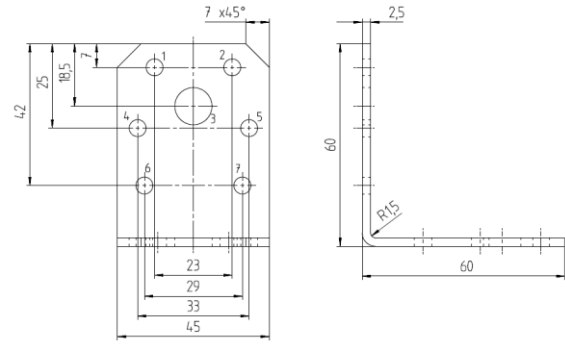
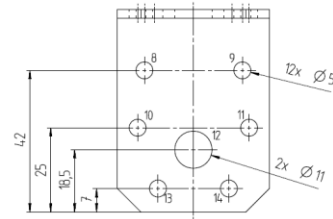
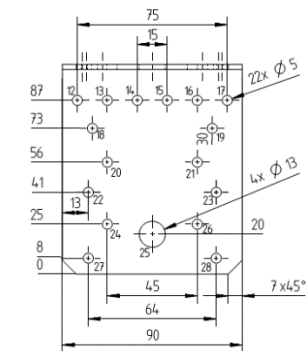

Figure A.34 Angle Bracket 8627



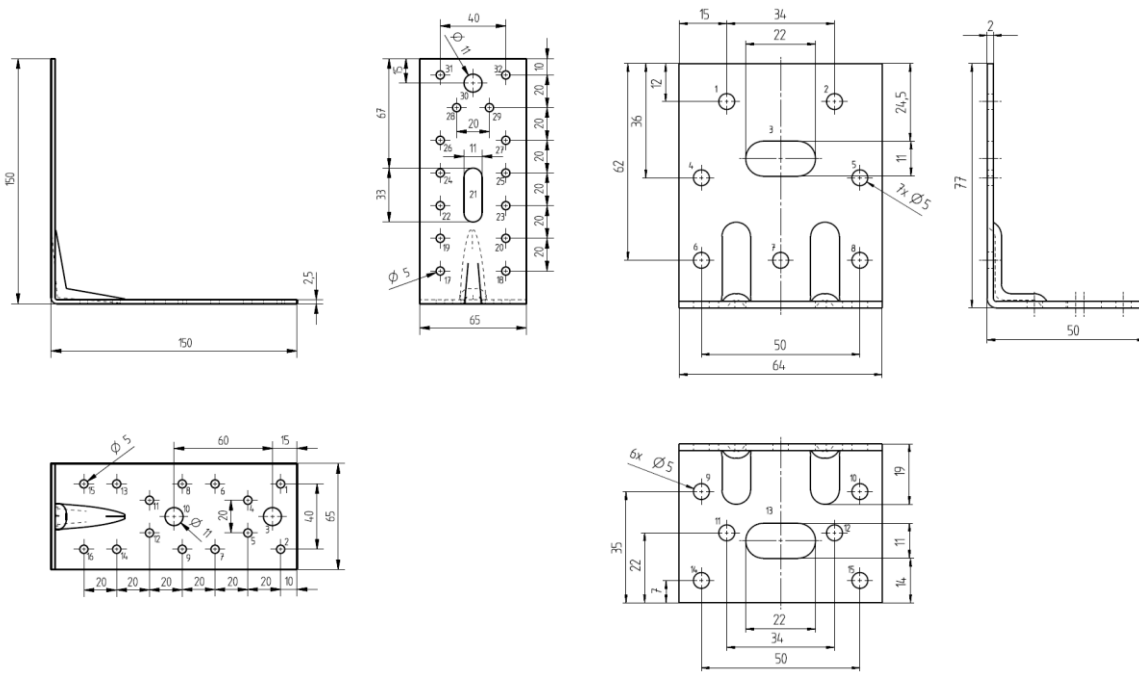

Figure A.35 Angle Bracket 8628

Figure A.36 Angle Bracket 8629

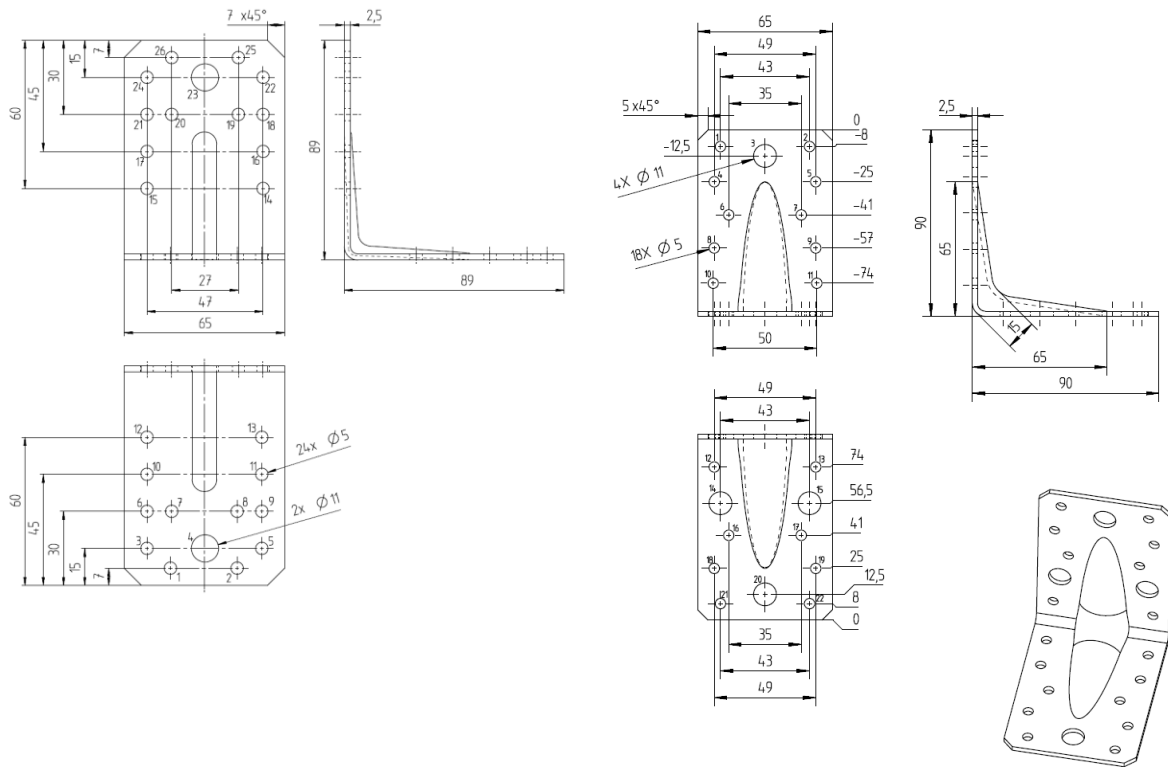

Figure A.37 Angle Bracket 8632

Figure A.38 Angle Bracket 8632 FH

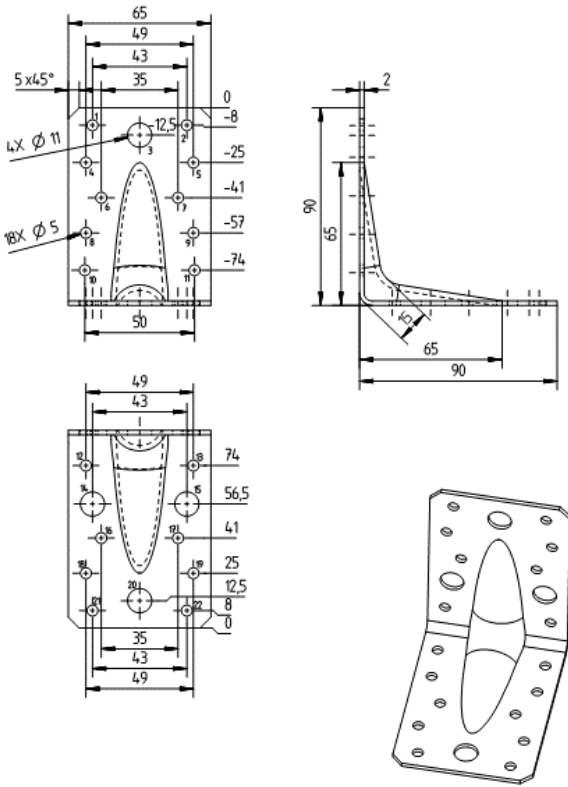

Figure A.39 Angle Bracket 8632 90FH 1Z2.0

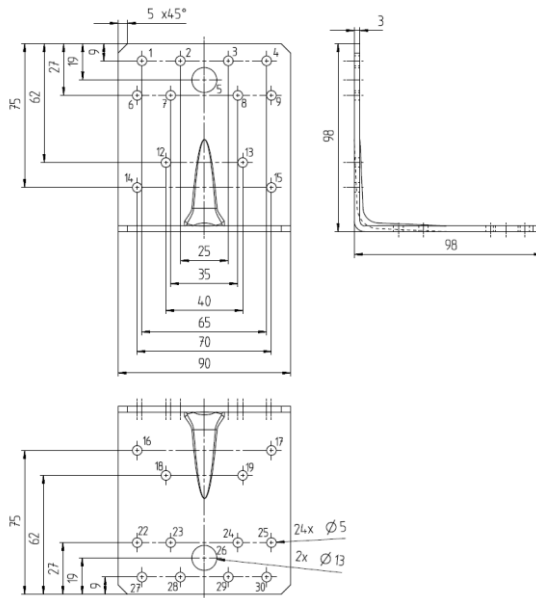

Figure A.40 Angle Bracket 8633

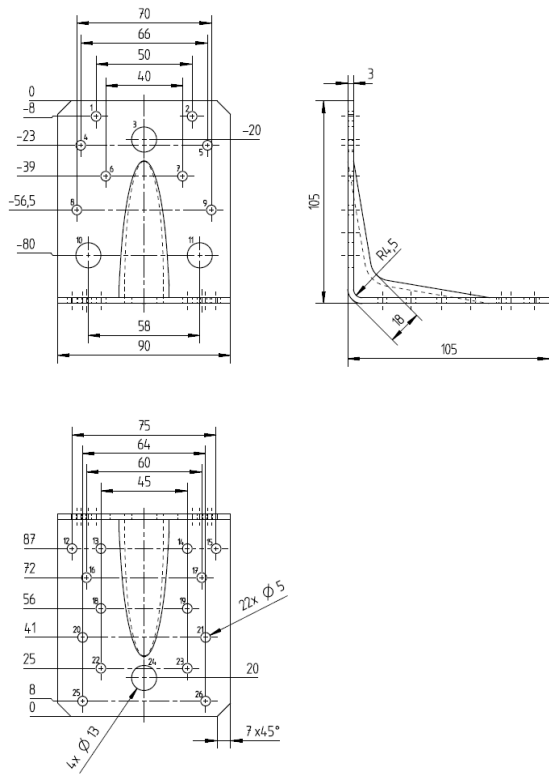

Figure A.41 Angle Bracket 8633 FH

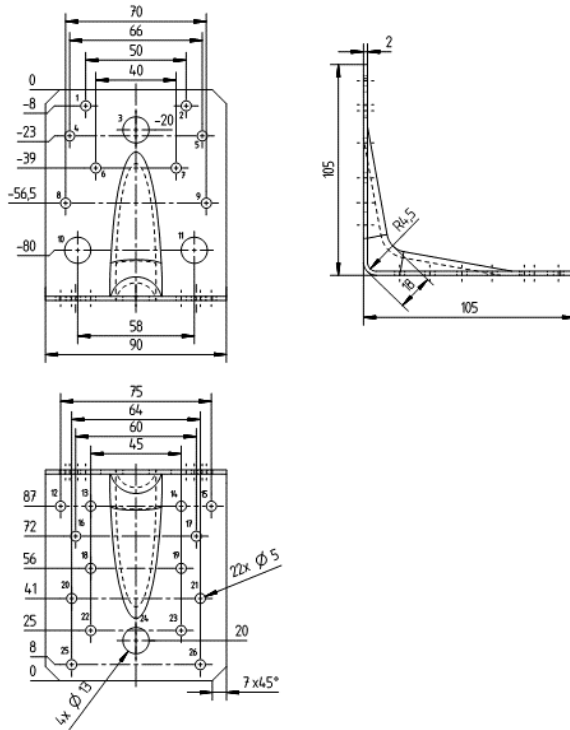

Figure A.42 Angle Bracket 8633 10FH 1Z2.0

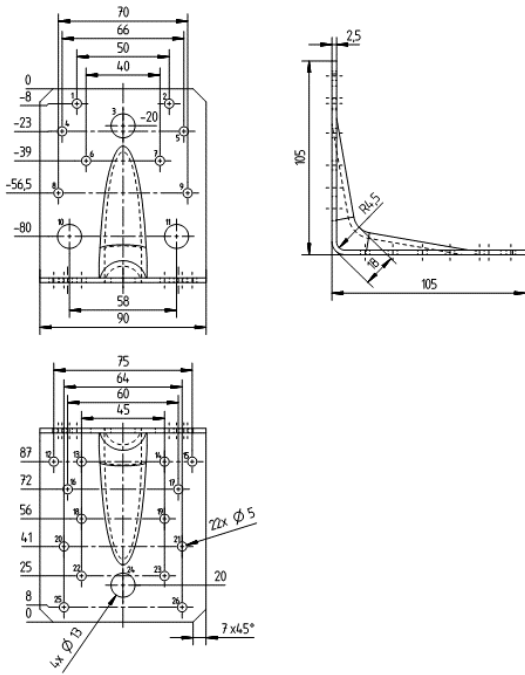

Figure A.43 Angle Bracket 8633 10FH 1Z2.5

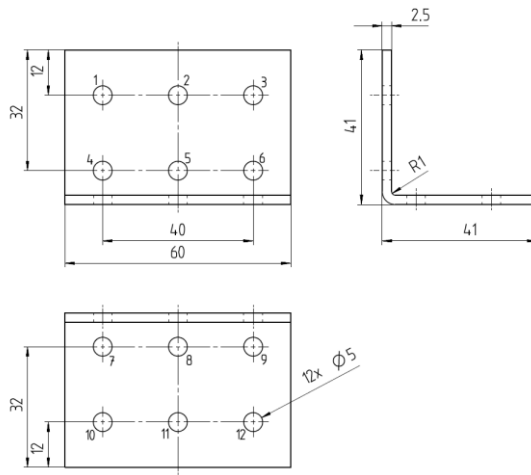

Figure A.44 Angle Bracket 8634

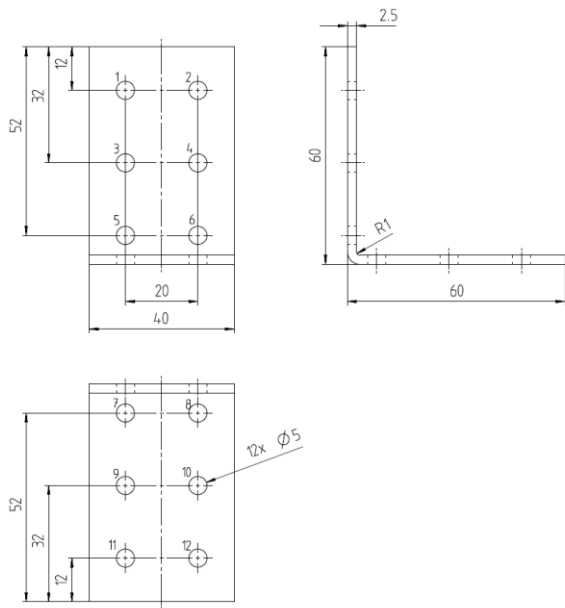

Figure A.45 Angle Bracket 8635

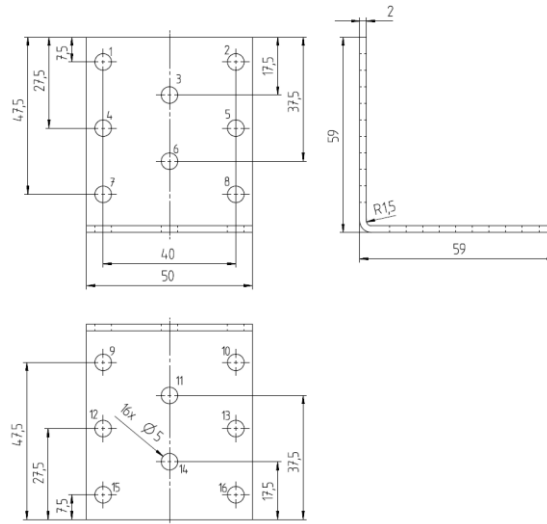

Figure A.46 Angle Bracket 8636

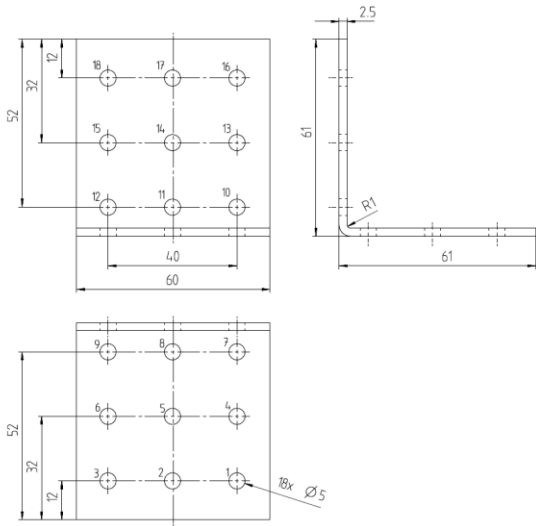

Figure A.47 Angle Bracket 8637

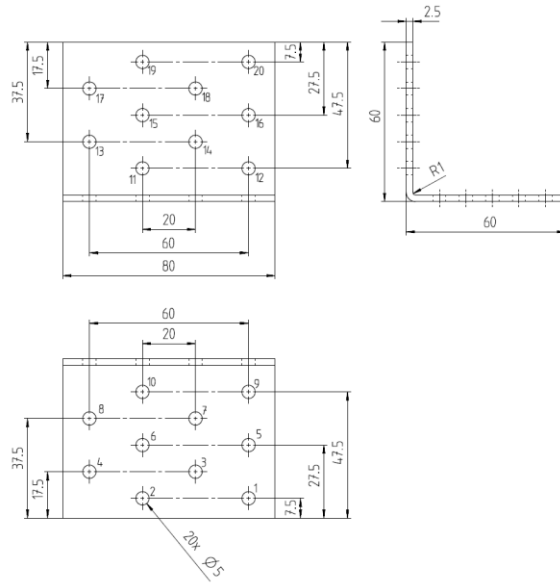

Figure A.48 Angle Bracket 8638

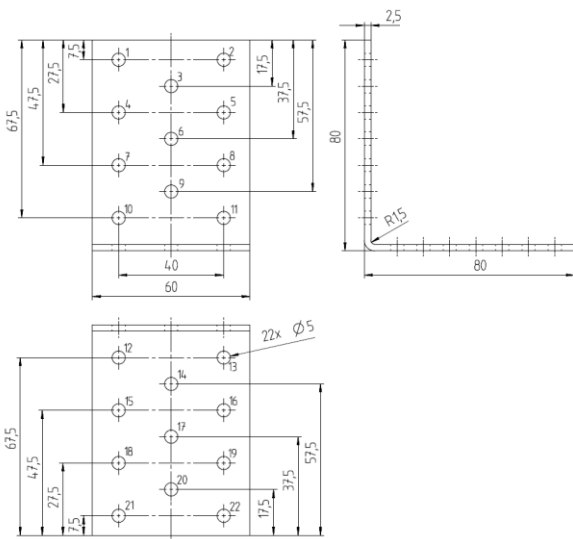

Figure A.49 Angle Bracket 8640

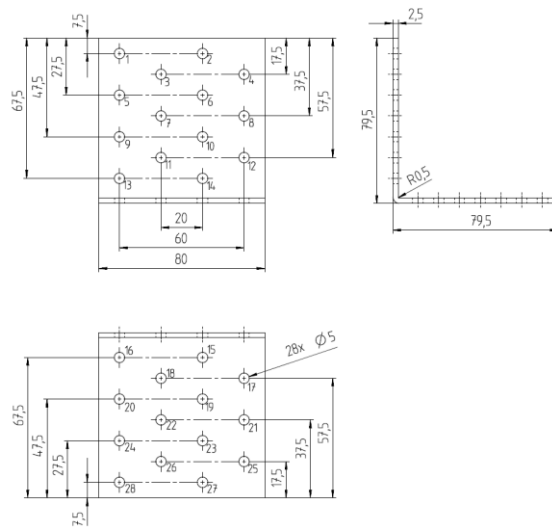

Figure A.50 Angle Bracket 8641

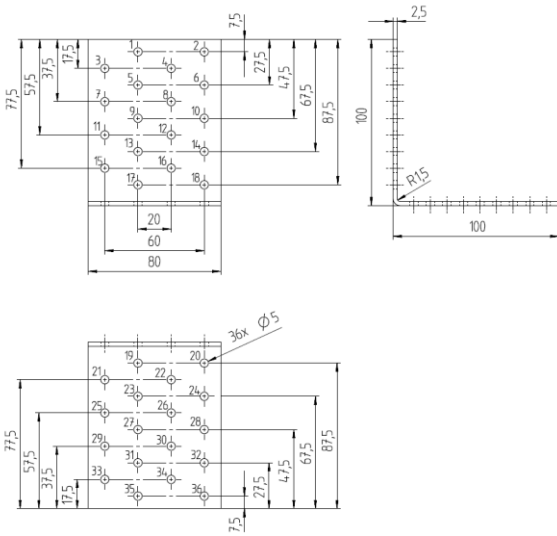

Figure A.51 Angle Bracket 8644

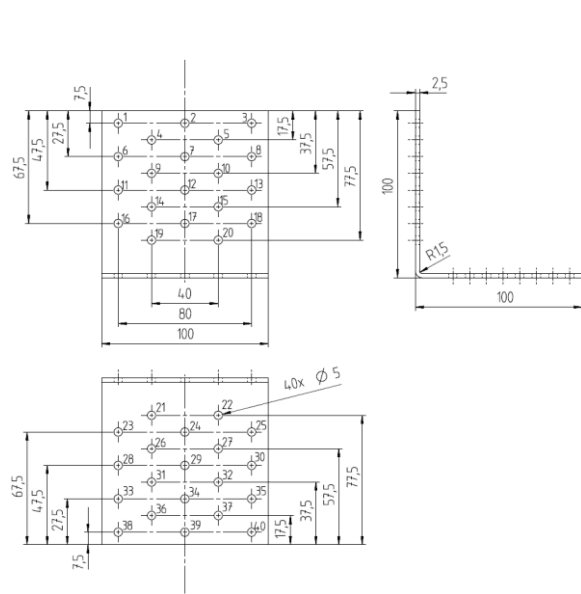

Figure A.52 Angle Bracket 8645

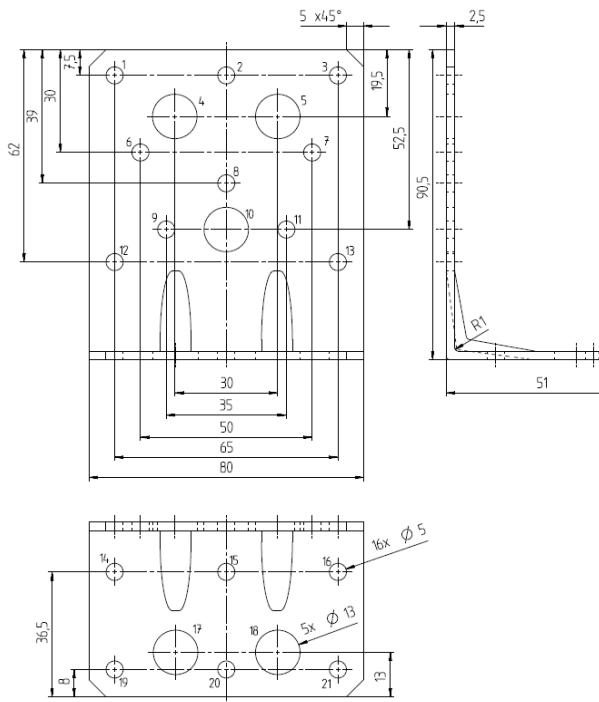

Figure A.53 Angle Bracket 8654

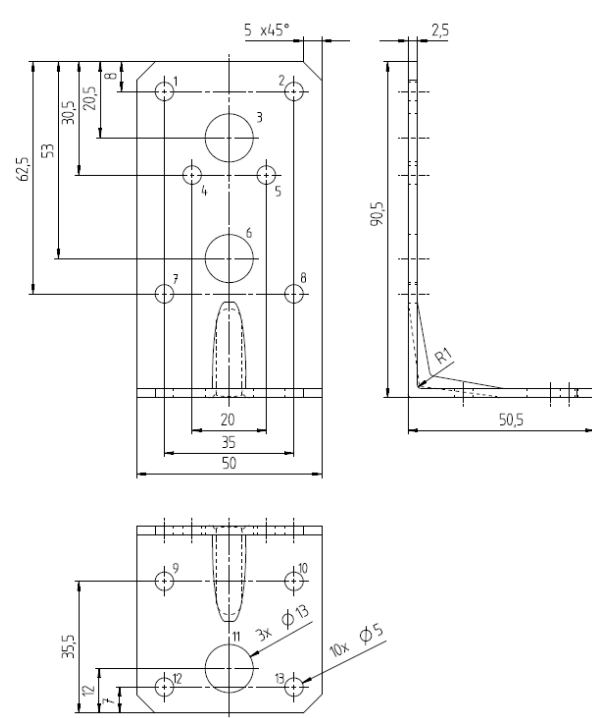

Figure A.54 Angle Bracket 8655

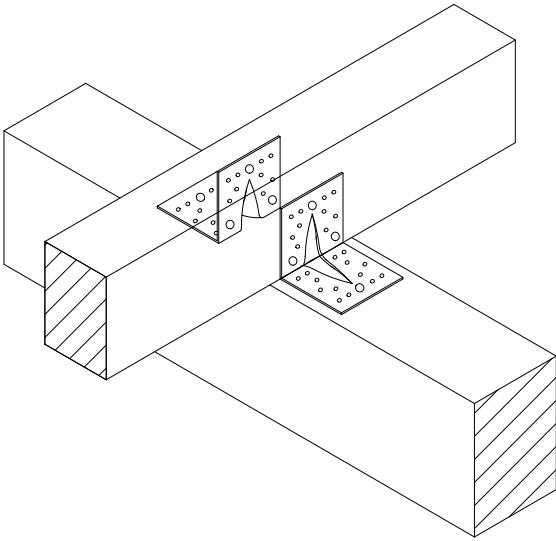

Figure A.55 Typical installation

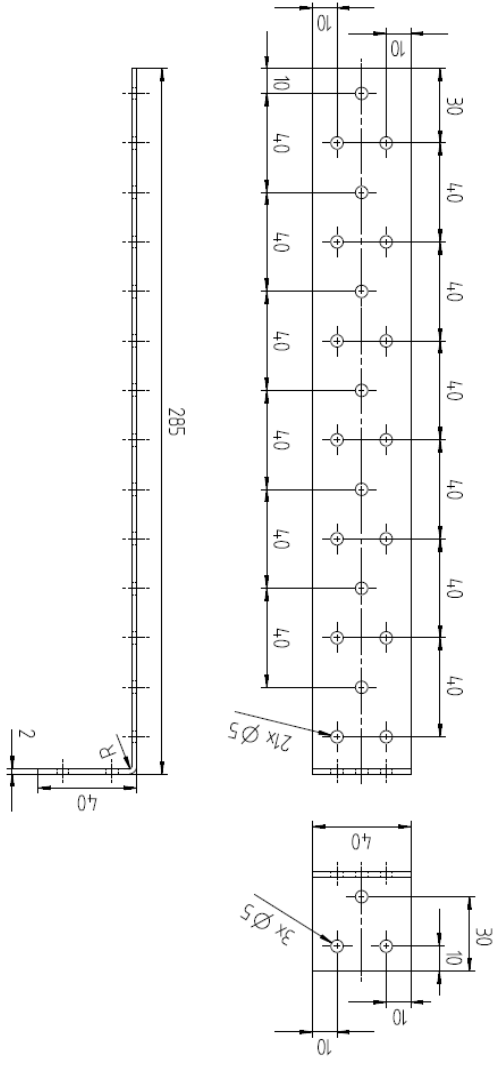

Figure A.59 hold-down 8792

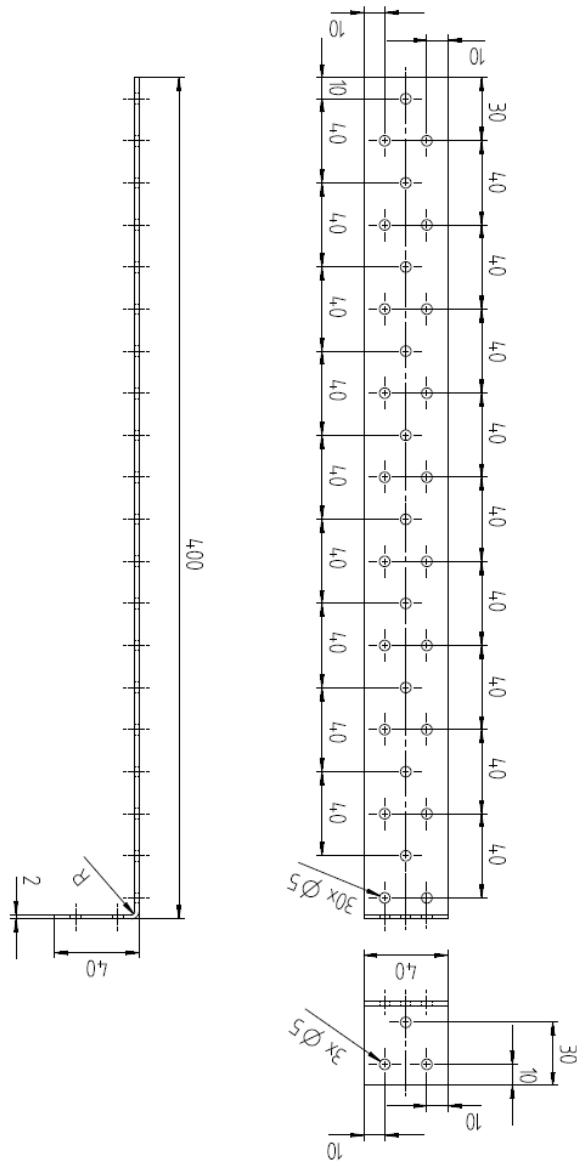

Figure A.60 hold-down 8793

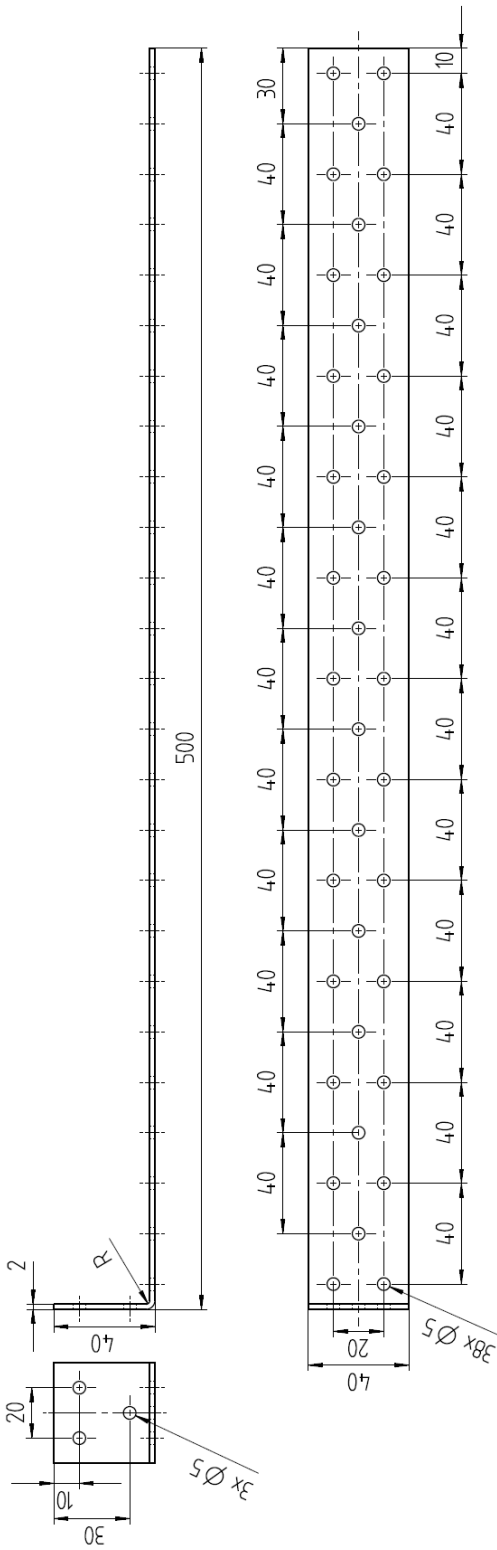

Figure A.61 hold-down 8794

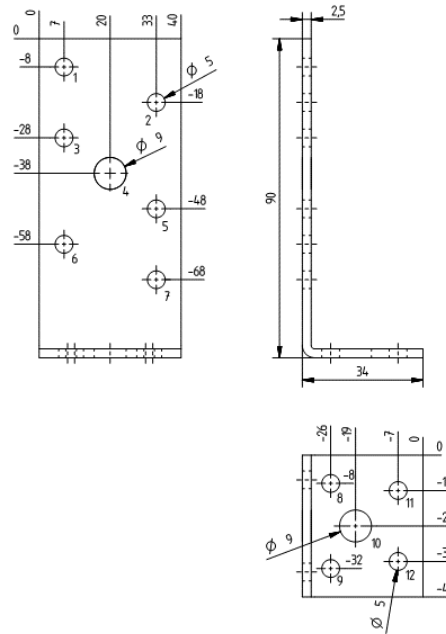

Figure A.62 hold-down 8795 0090 1FH

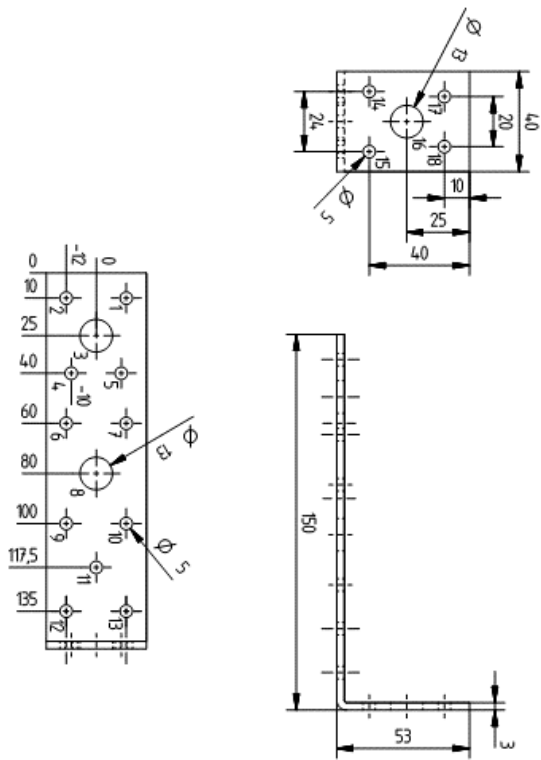

Figure A.63 hold-down 8795 1603 1

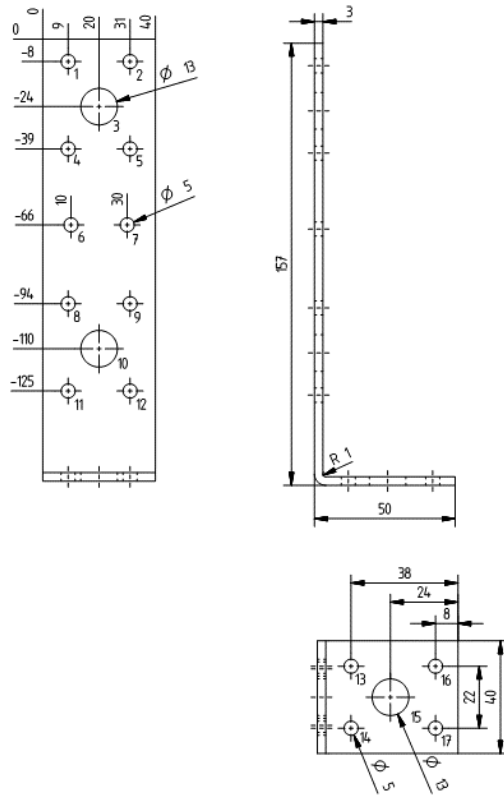

Figure A.64 hold-down 8795 1603 1FH

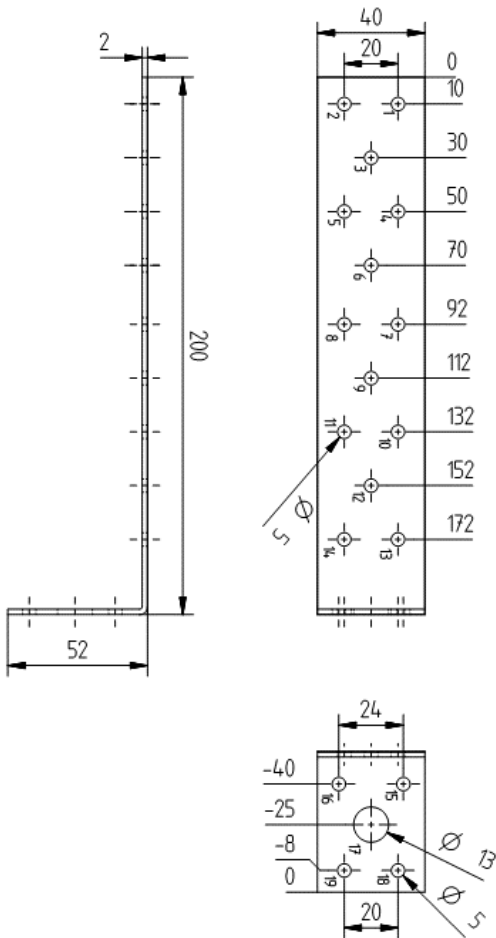

Figure A.65 hold-down 8795 2002 1D

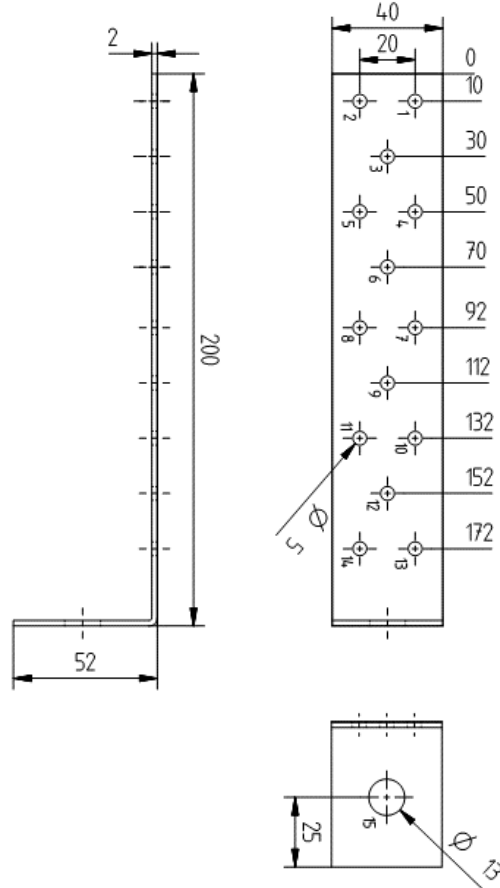

Figure A.66 hold-down 8795 2002 1E

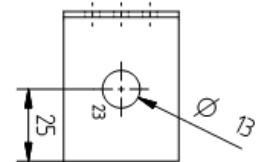
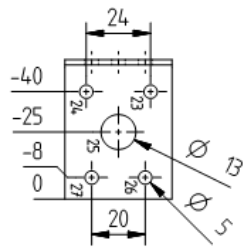
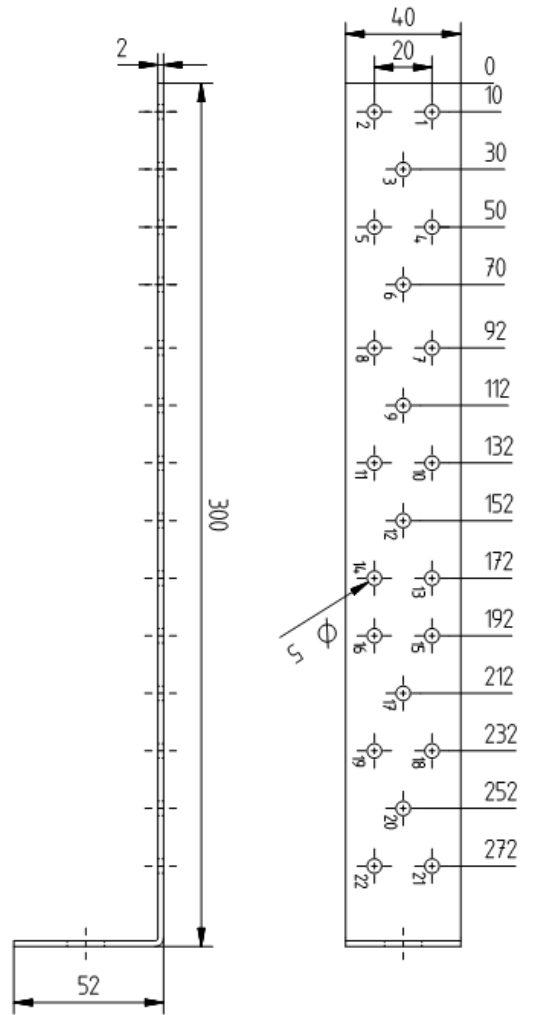
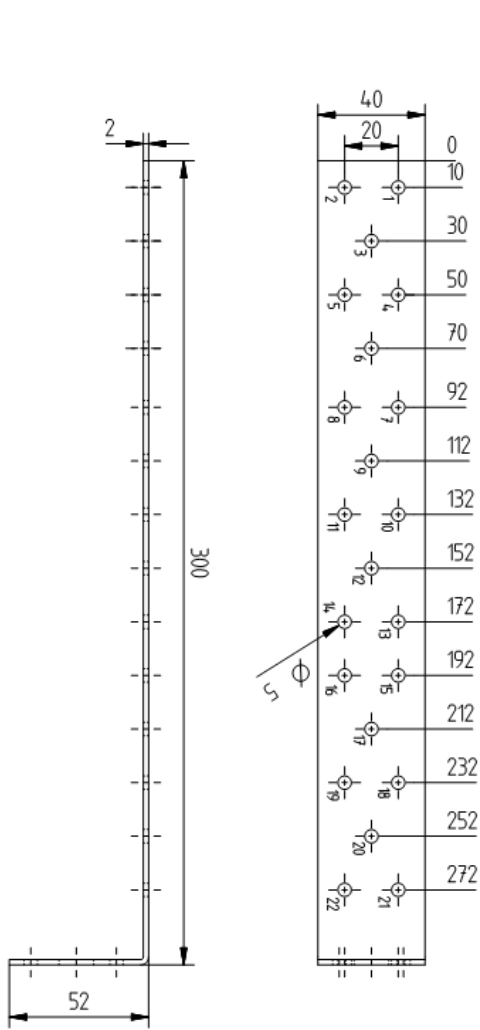

Figure A.67 hold-down 8795 3002 1D

Figure A.68 hold-down 8795 3002 1E

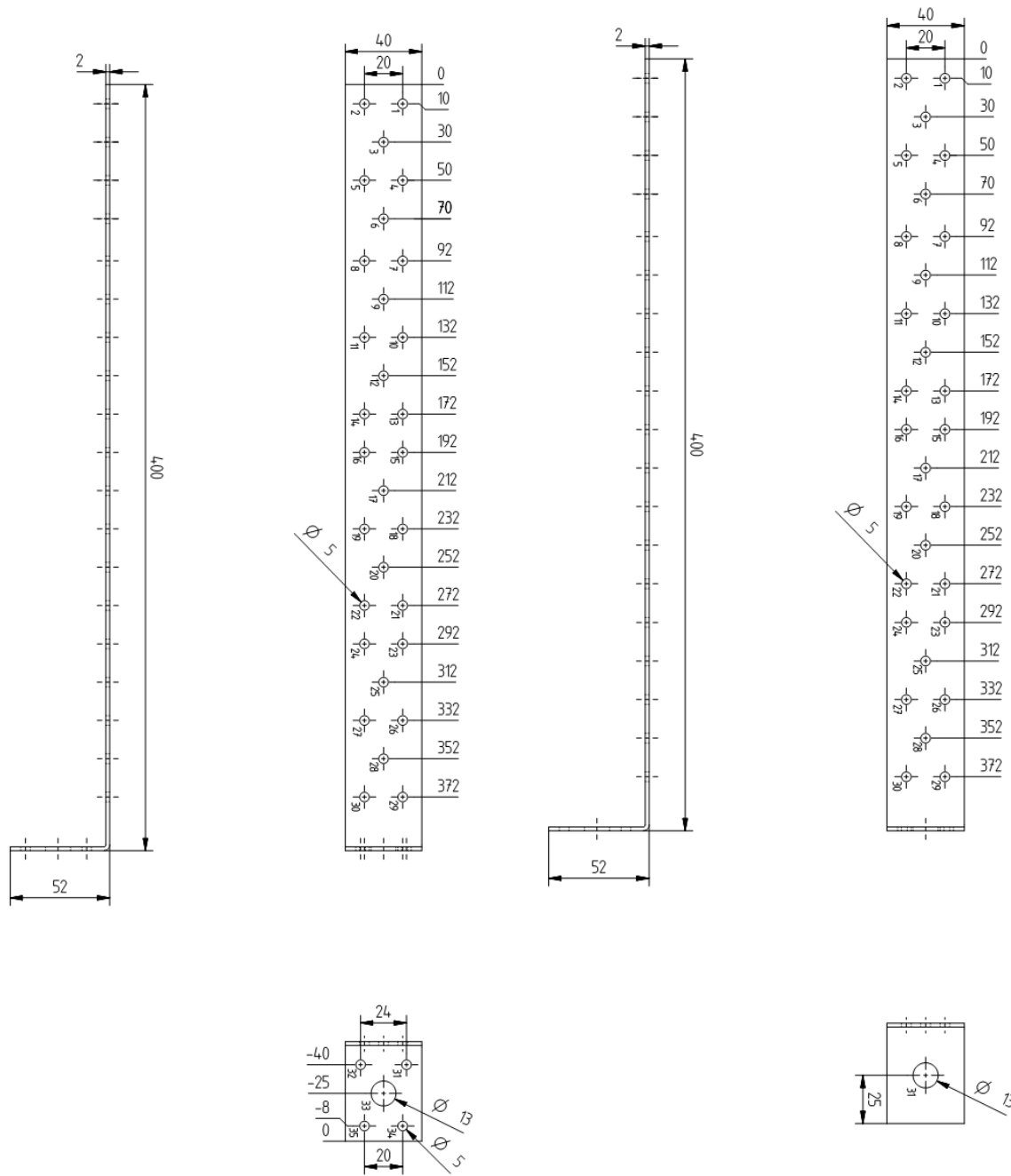

Figure A.69 hold-down 8795 4002 1D

Figure A.70 hold-down 8795 4002 1E

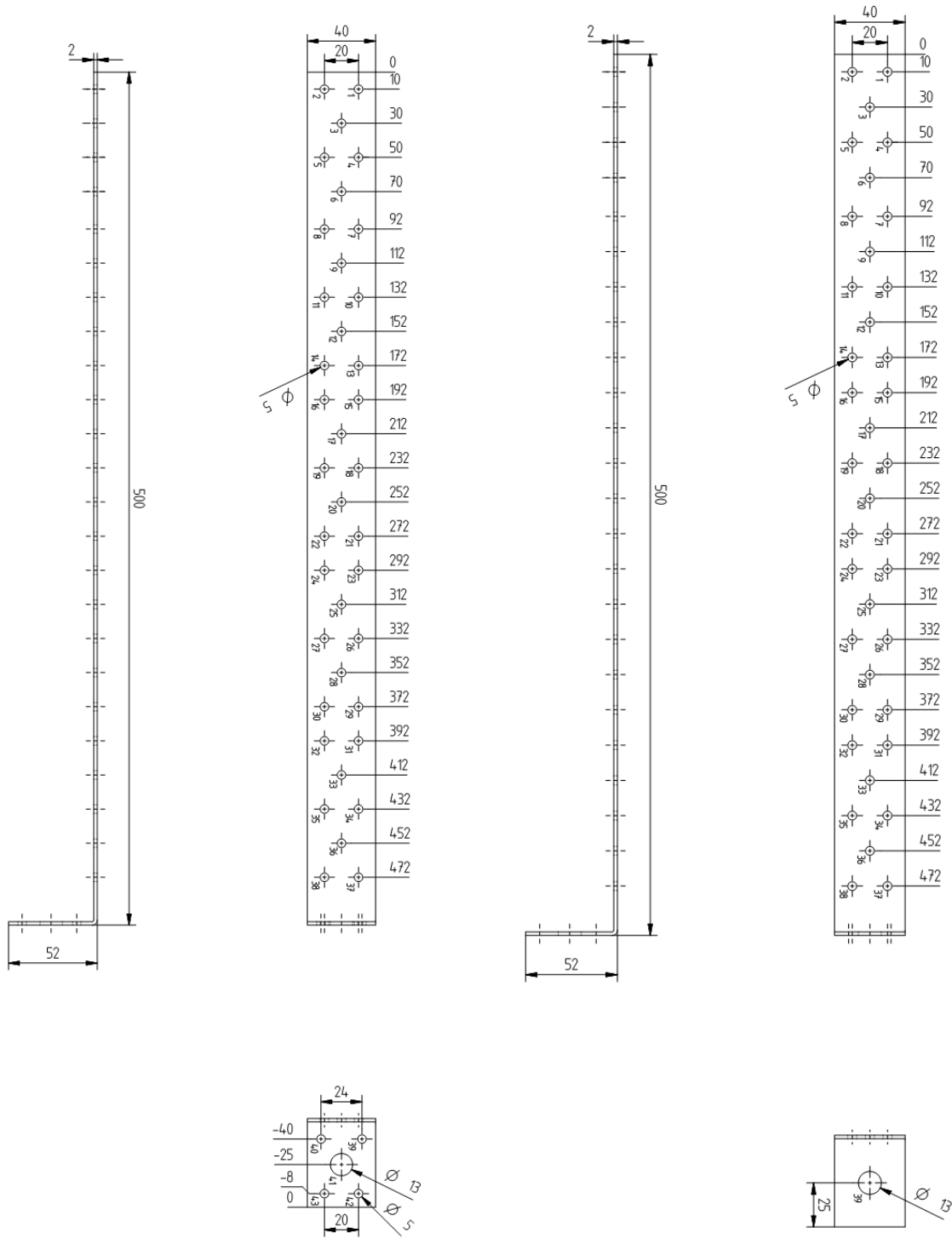

Figure A.71 hold-down 8795 5002 1D

Figure A.72 hold-down 8795 5002 1E

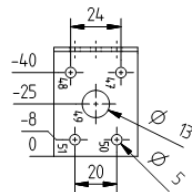
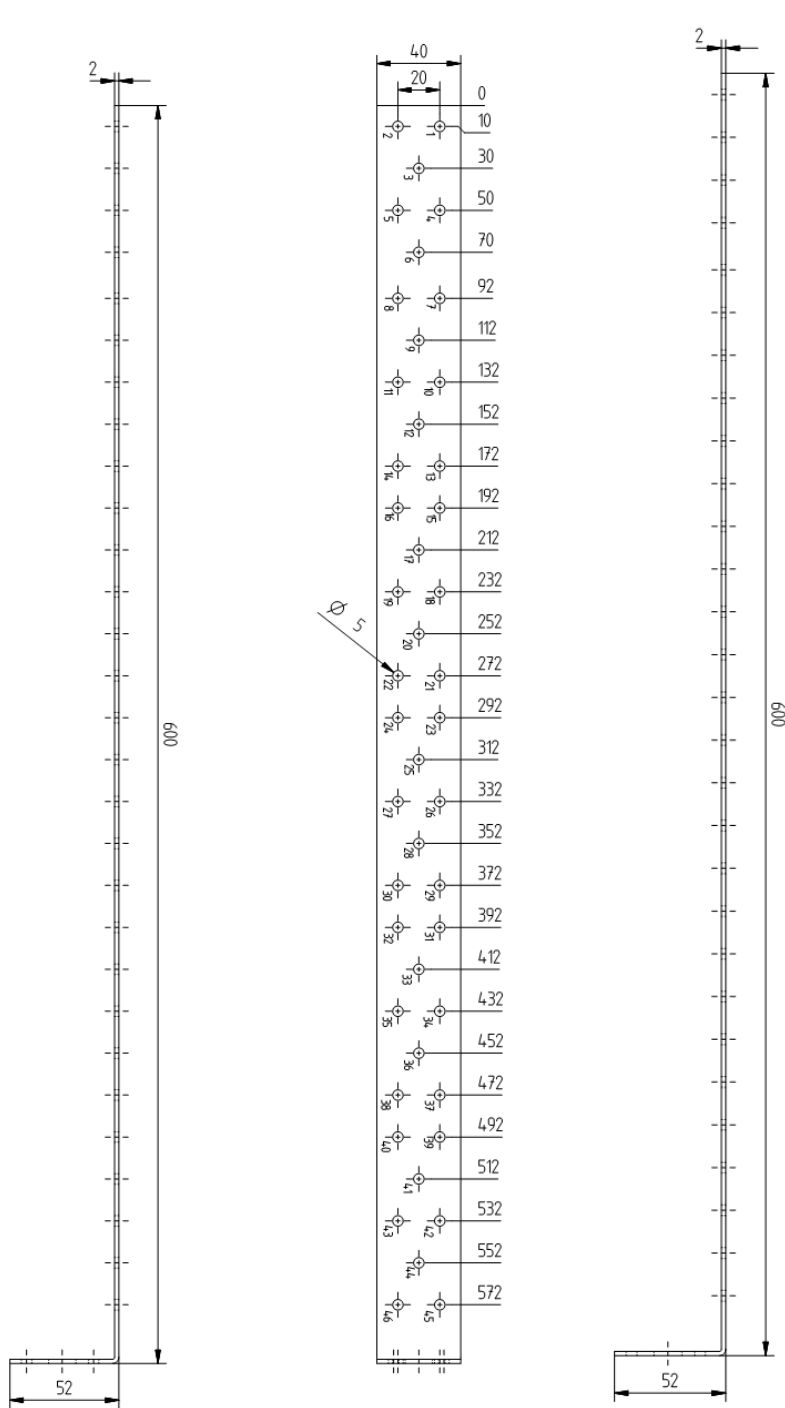

Figure A.73 hold-down 8795 6002 1D

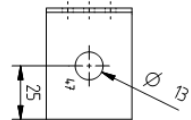
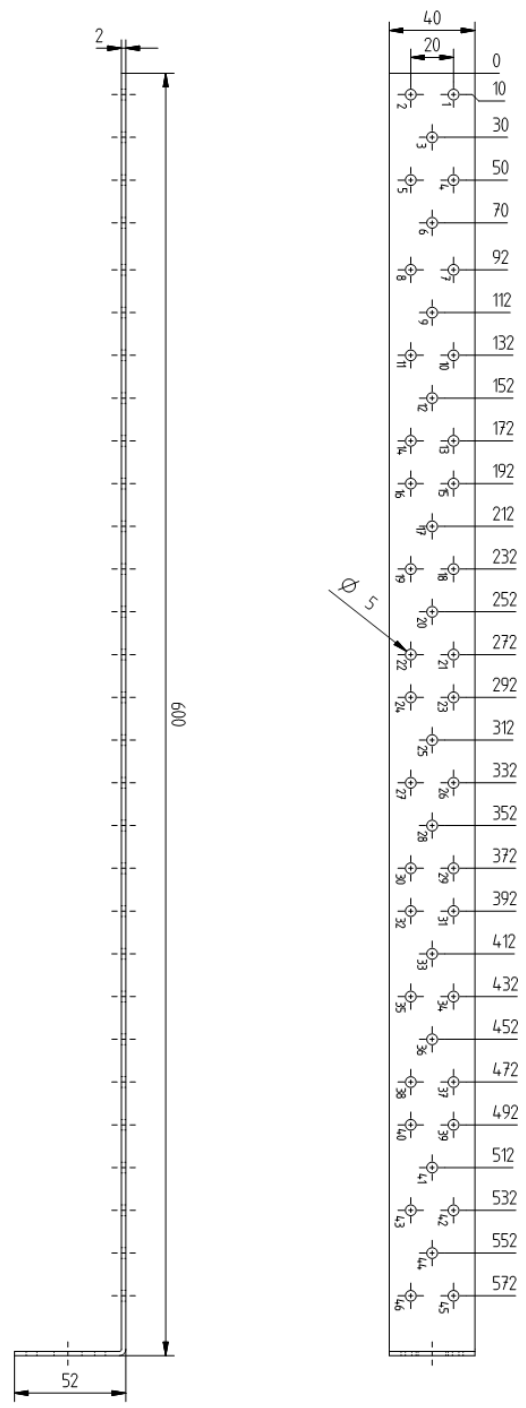

Figure A.74 hold-down 8795 6002 1E

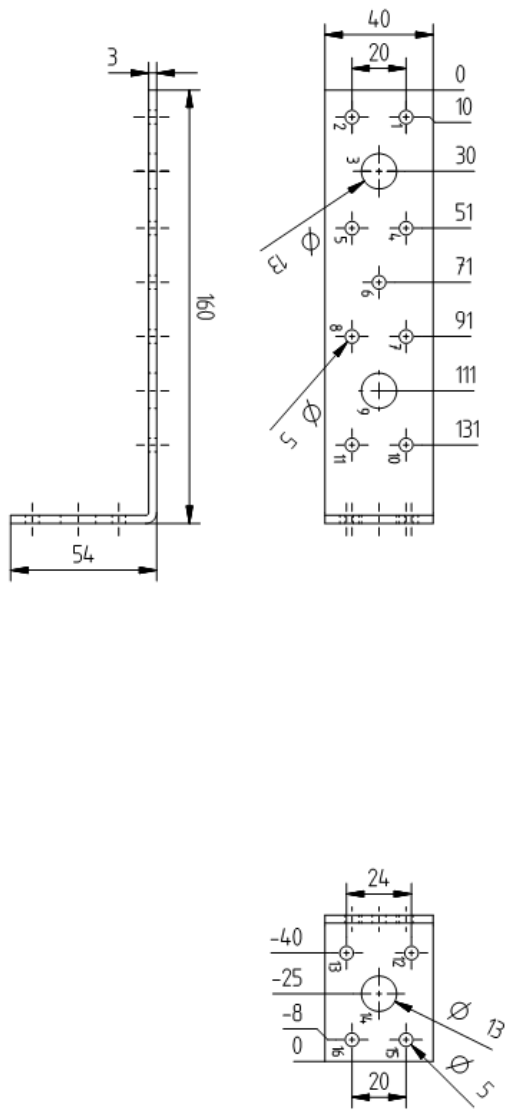

Figure A.75 hold-down 8799 1603 1D

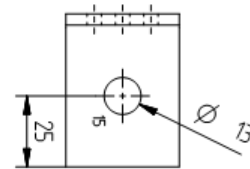
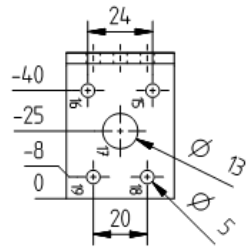
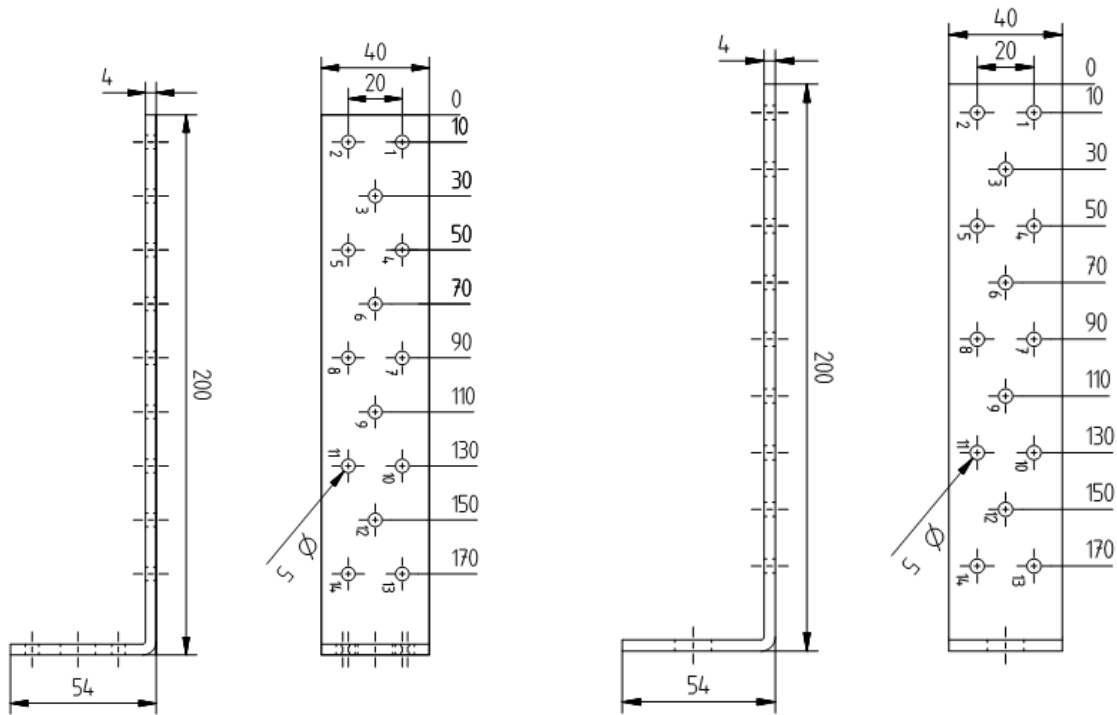

Figure A.76 hold-down 8799 2004 1D

Figure A.77 hold-down 8799 2004 1E

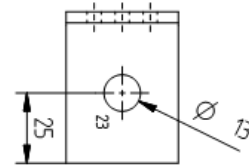
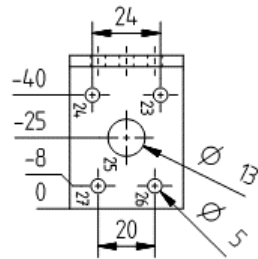
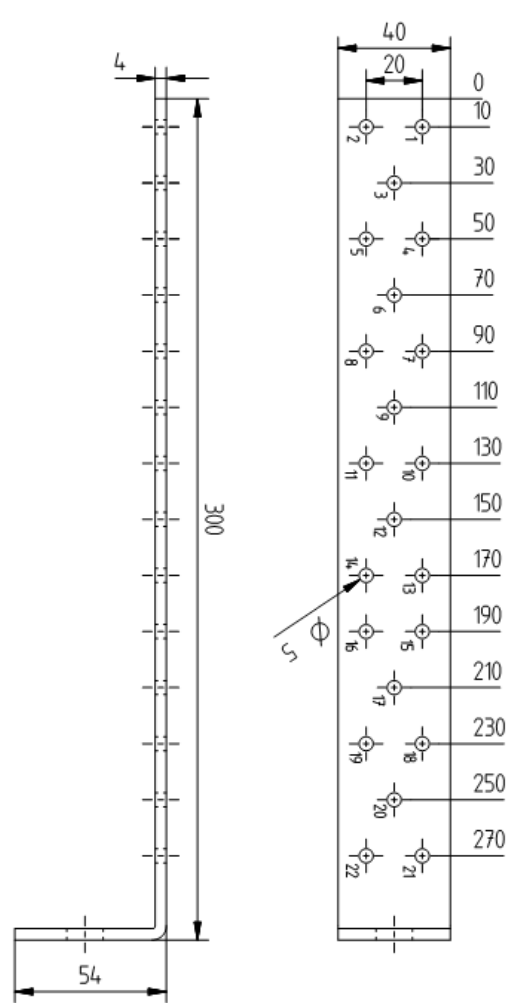
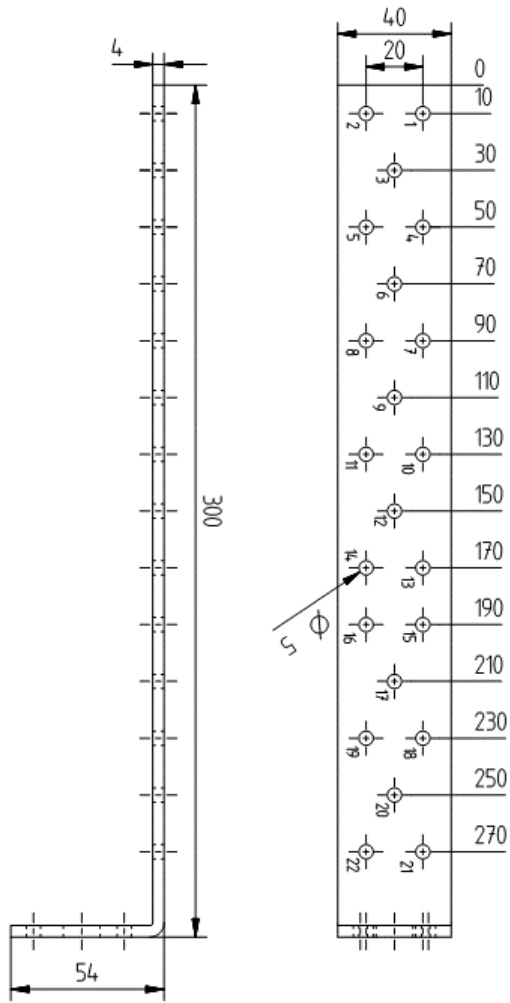

Figure A.78 hold-down 8799 3004 1D

Figure A.79 hold-down 8799 3004 1E

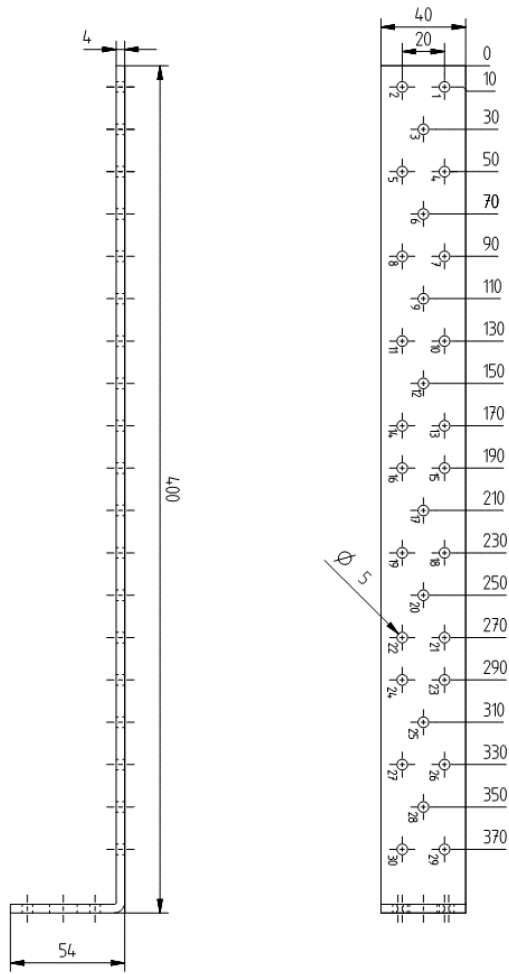

Figure A.80 hold-down 8799 4004 1D

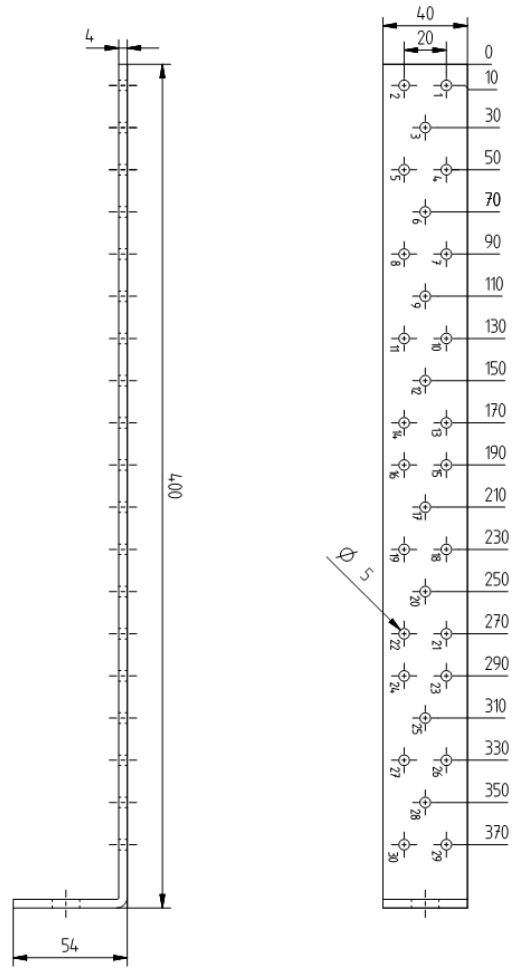

Figure A.81 hold-down 8799 4004 1E

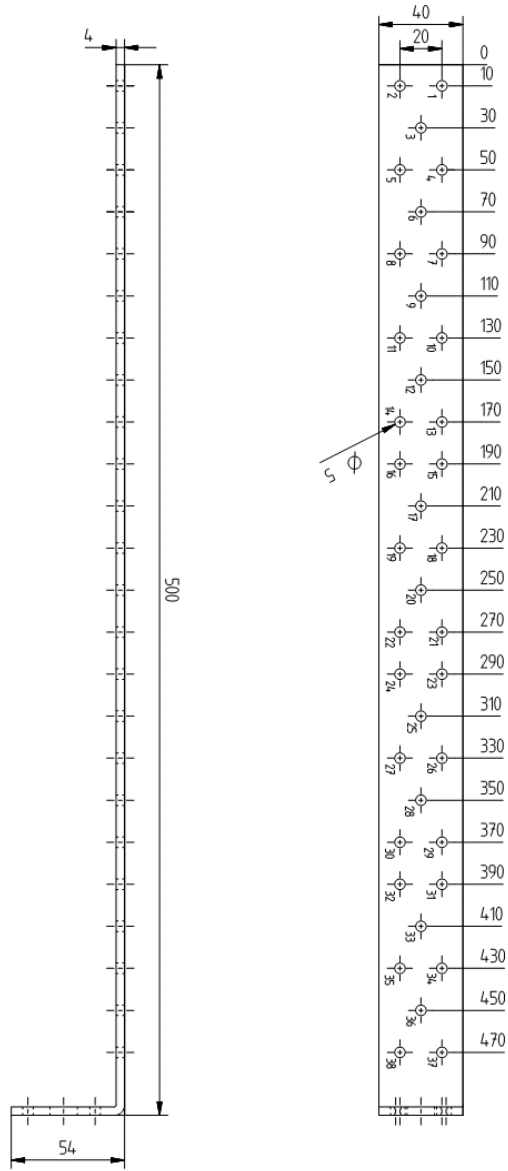

Figure A.82 hold-down 8799 5004 1D

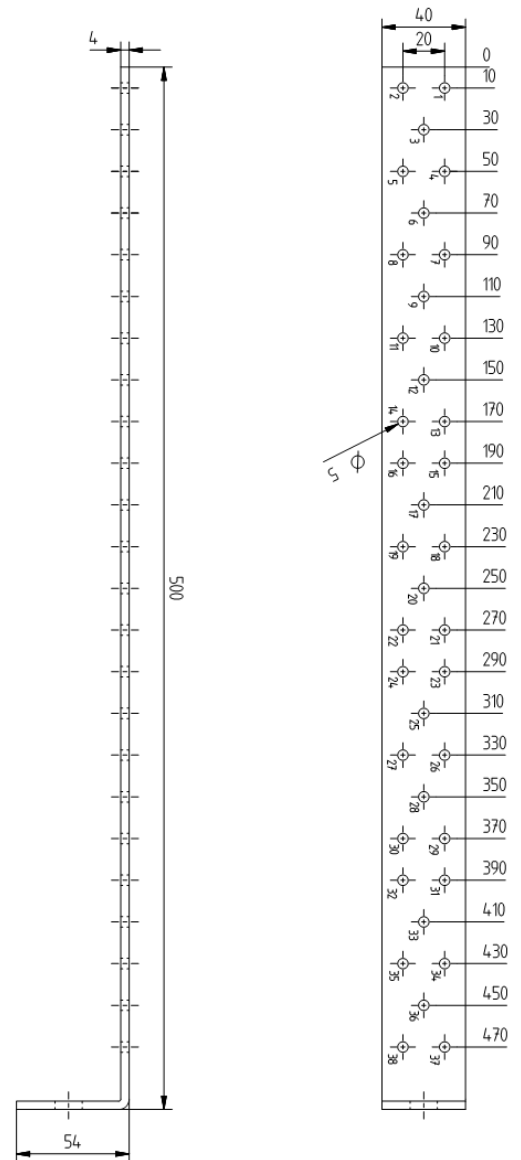
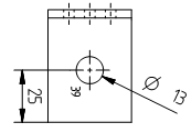
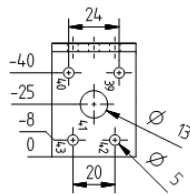

Figure A.83 hold-down 8799 5004 1E



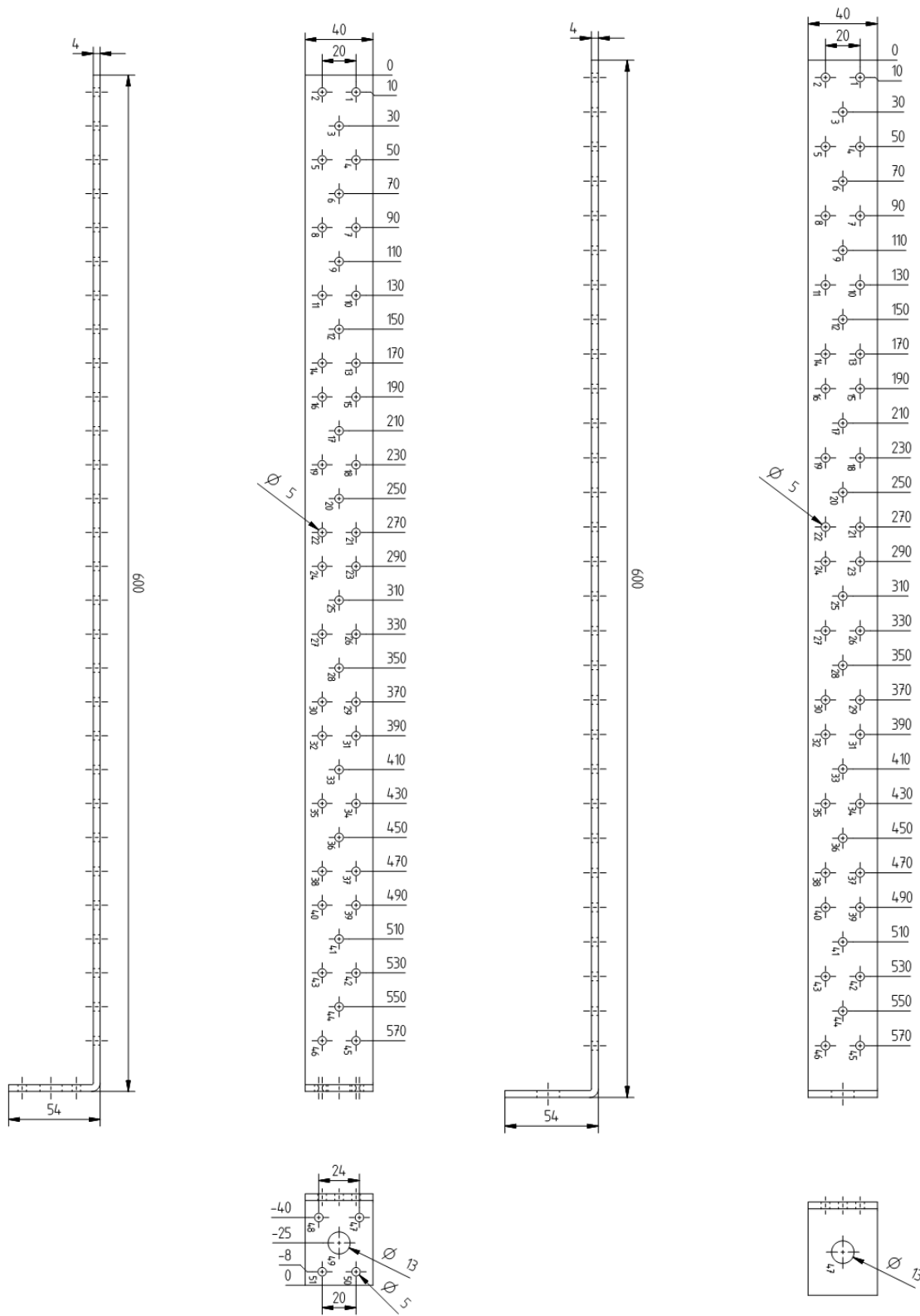

Figure A.84 hold-down 8799 6004 1D

Figure A.85 hold-down 8799 6004 1E

Nail Patterns – Angle Brackets in Load Cases F₁, F₂/F₃, F₄/F₅

Angle Bracket 8573 0095 1 and 8573 1395 1

F₁– column

Nails/Bolts in hole number:
11,12,13/
4

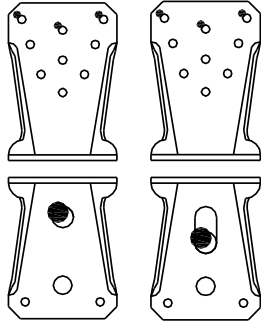

F₁ – purlin, F₂/F₃, F₄/F₅

Nails/Bolts in hole number:
5,6,7,8,9,10,11,12,13/
4

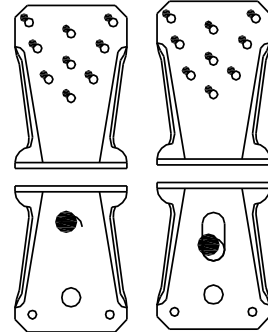

Angle Bracket 8573 0135 1 and 8573 13135 1

F₁– column

Nails/Bolts in hole number:
11,12,13,17,18,19/
4

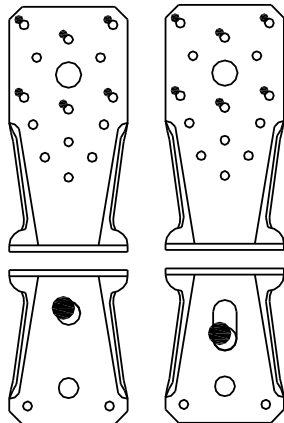

F₁ – purlin, F₂/F₃, F₄/F₅

Nails/Bolts in hole number:
5,6,7,8,9,10,11,12,13,
15,16,17,18,19/
4

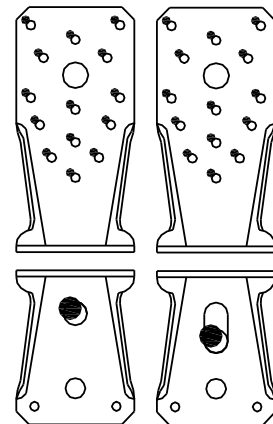

Angle Bracket 8573 0285 1 and 8573 13285 1

F₁– column

Nails/Bolts in hole number:

11,12,13,15,16,17,18,
19,21,22,23,24,25,26,
27,28,29,30,32,33/
4

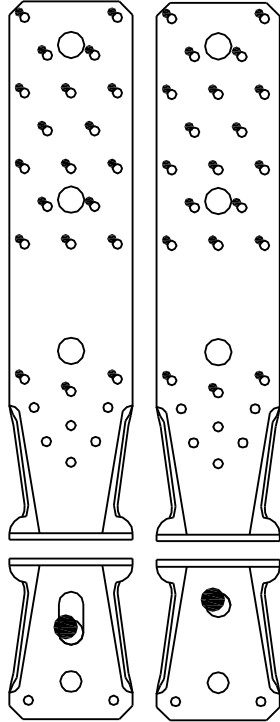

F₁ – purlin, F₂/F₃, F₄/F₅

Nails/Bolts in hole number:

5,6,7,8,9,10,11,12,13,15,16,
17,18,19,21,22,23,24,25,26,
27,28,29,30,32,33/
4

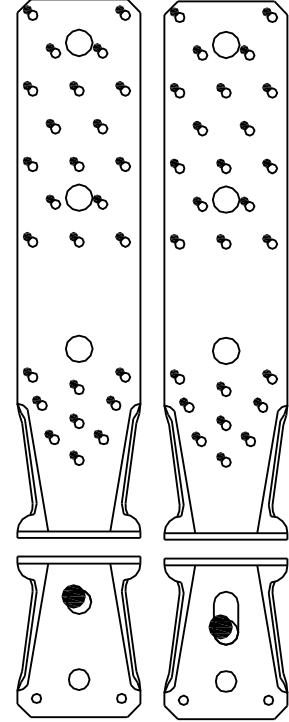

Angle Bracket 8590 1020 1

F₁– column

Nails in hole number:

1 ÷ 10 /
24 ÷ 71

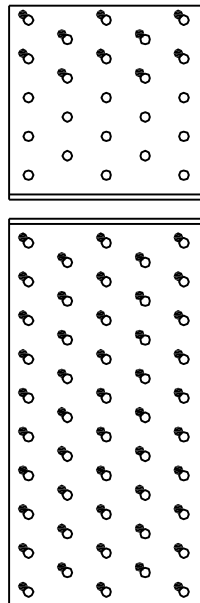

F₁ – purlin, F₂/F₃, F₄/F₅

Nails in hole number:

1 ÷ 18 /
24 ÷ 71

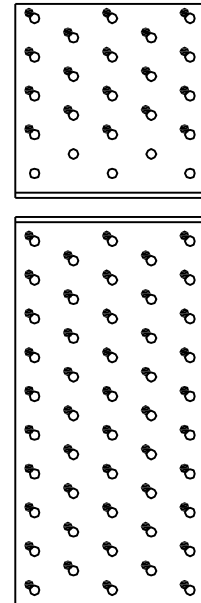

Angle Bracket 8591 1060 1

F₁– column

Nails in hole number:

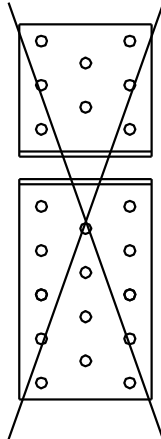

F₁ – purlin, F₂/F₃, F₄/F₅

Nails in hole number:

1,2,3,4,5/
9 ÷ 22

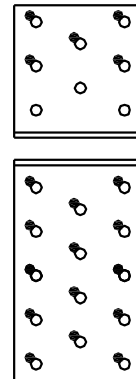

Angle Bracket 8592 6060 1

F₁– column

Nails in hole number:

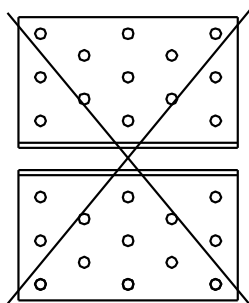

F₁ – purlin, F₂/F₃, F₄/F₅

Nails in hole number:

1,2,3,4,5,6,7,8/
14 ÷ 26

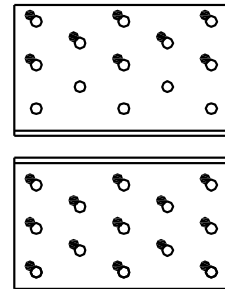

Angle Bracket 8593 6060 1

F₁– column

Nails in hole number:

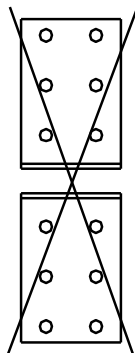

F₁ – purlin, F₂/F₃, F₄/F₅

Nails in hole number:

1,2,3,4/
7,8,9,10,11,12

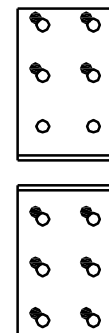

Angle Bracket 8594 6060 1

F₁– column

Nails in hole number:

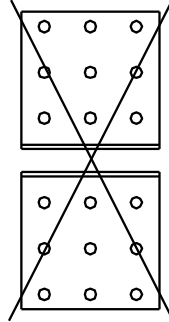

F₁ – purlin, F₂/F₃, F₄/F₅

Nails in hole number:

1,2,3,4,5,6/
10 ÷ 18

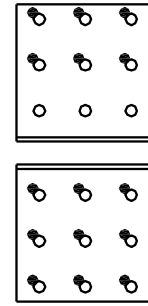

Angle Bracket 8595 8080 1

F₁– column

Nails in hole number:

1,2,3,4,5/
18 ÷ 34

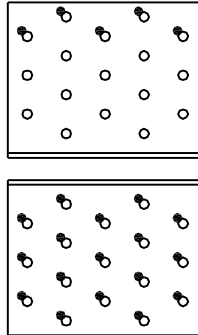

F₁ – purlin, F₂/F₃, F₄/F₅

Nails in hole number:

1 ÷ 12 /
18 ÷ 34

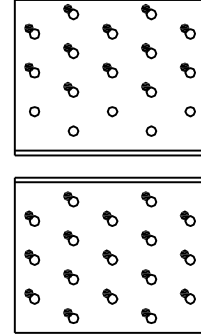

Angle Bracket 8596 460 1

F₁– column

Nails in hole number:

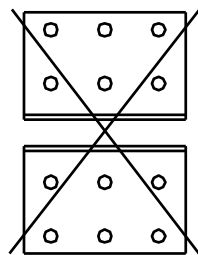

F₁ – purlin, F₂/F₃, F₄/F₅

Nails in hole number:

1,2,3/
7,8,9,10,11,12

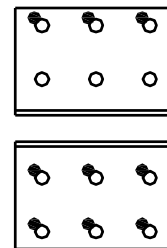

Angle Bracket 8597 8080 1

F₁– column

Nails in hole number:
1,2,3,4/
15 ÷ 28

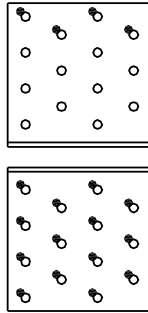

F₁ – purlin, F₂/F₃, F₄/F₅

Nails in hole number:
1 ÷ 10/
15 ÷ 28

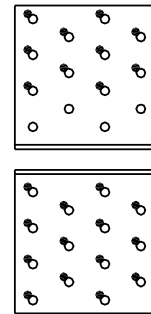

Angle Bracket 8612

Timber to Timber

F₁– column

Nails in hole number:

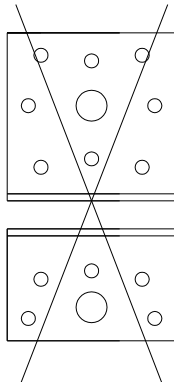

F₁ – purlin, F₂/F₃, F₄/F₅

Nails in hole number:
1,2,3,4,6 /
10,11,12

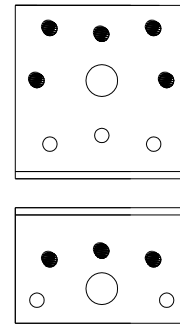

Timber to Concrete

F₁– column

Nails in hole number:

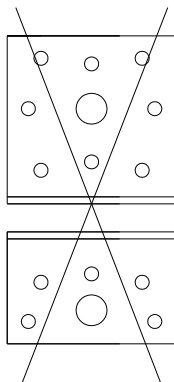

F₁ – purlin, F₂/F₃, F₄/F₅

Nails in hole number:
1,2,3,4,6 /
10,11,12

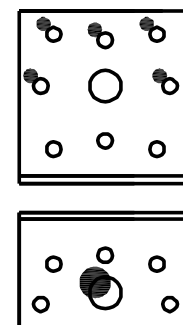

Angle Bracket 8613

Timber to Timber

F₁– column

Nails in hole number:
1,2,3 /
13,14,15,16,18,19,20,21

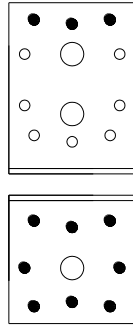

F₁ – purlin, F₂/F₃, F₄/F₅

Nails in hole number:
1,2,3,4,6,7,8 /
13,14,15,16,18,19,20,21

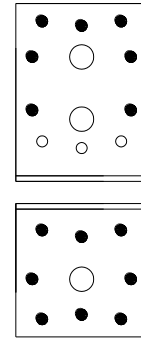

Timber to Concrete

F₁– column

Nails in hole number:
1,2,3 /
17

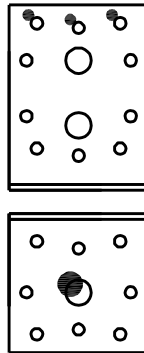

F₁ – purlin, F₂/F₃, F₄/F₅

Nails in hole number:
1,2,3,4,6,7,8 /
17

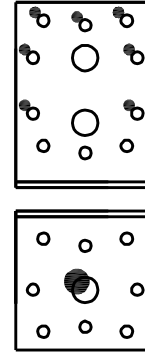

Angle Bracket 8614

F₁– column

Nails in hole number:
1,2 /
7,8,9,10,11,12

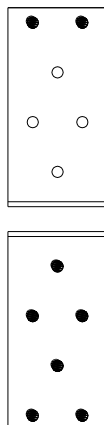

F₁ – purlin, F₂/F₃, F₄/F₅

Nails in hole number:
1,2,3,4,5 /
7,8,9,10,11,12

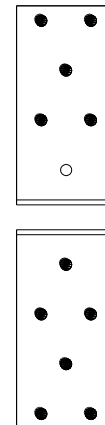

Angle Bracket 8615

F₁– column

Nails in hole number:
1,2,3 /
8,9,10,11,12,13,14

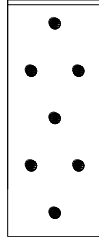
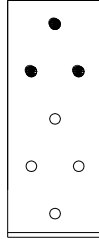

F₁ – purlin, F₂/F₃, F₄/F₅

Nails in hole number:
1,2,3,4,5,6 /
8,9,10,11,12,13,14

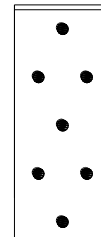
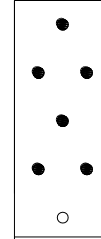

Angle Bracket 8616

F₁– column

Nails in hole number:
1,2,3,4,5,6 /
15 ÷ 28

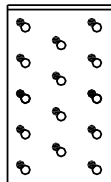
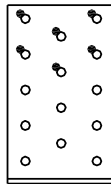

F₁ – purlin, F₂/F₃, F₄/F₅

Nails in hole number:
1,2,3,4,5,6,7,8,9,10,11 /
15 ÷ 28

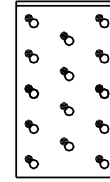
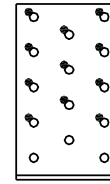

Angle Bracket 8617

Timber to Timber

F₁– column

Nails in hole number:
1,2,3,7,8,9/
16,17,19,21,23,24

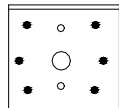
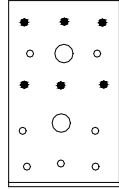

F₁ – purlin, F₂/F₃, F₄/F₅

Nails in hole number:
1,3,5,6,7,9,11,12 /
16,17,19,21,23,24

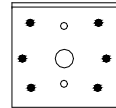
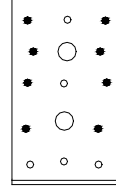

Timber to Concrete

F₁– column

Nails in hole number:
1,2,3,7,8,9/
20

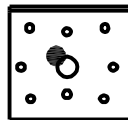
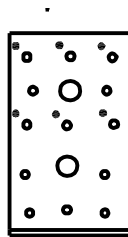

F₁ – purlin, F₂/F₃, F₄/F₅

Nails in hole number:
1,3,5,6,7,9,11,12 /
20

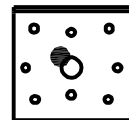
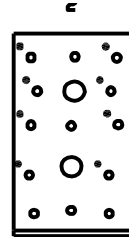

Angle Bracket 8620

F₁– column

Nails in hole number:

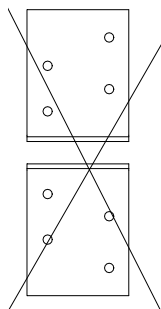

F₁ – purlin, F₂/F₃, F₄/F₅

Nails in hole number:
1,2 /
5,6,7,8

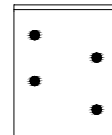
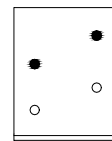

Angle Bracket 8621

F₁– column

Nails in hole number:

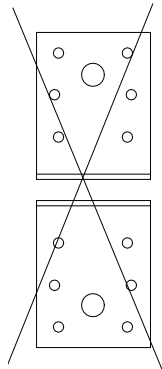

F₁ – purlin, F₂/F₃, F₄/F₅

Nails in hole number:

4,5 /
8,9,13,14

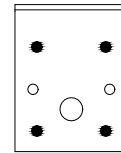
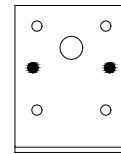

Angle Bracket 8622 and 8622 7070 1FH

Timber to Timber

F₁– column

Nails in hole number:

1,2 /
10,11,14,15,17,18

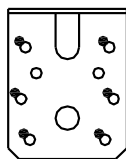
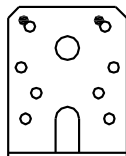

F₁ – purlin, F₂/F₃, F₄/F₅

Nails in hole number:

1,2,6,7 /
10,11,14,15,17,18

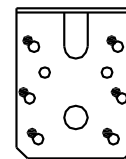
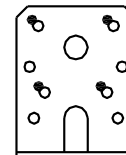

Timber to Concrete

F₁– column

Nails in hole number:

1,2 /
16

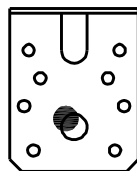
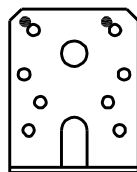

F₁ – purlin, F₂/F₃, F₄/F₅

Nails in hole number:

1,2,6,7 /
16

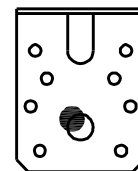
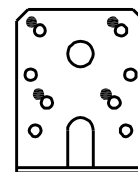

Angle Bracket 8623

Timber to Timber

F₁– column

Nails in hole number:
1,2,6,7 /
11,12,14,15,19,20

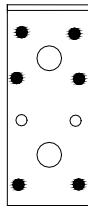
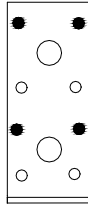

F₁ – purlin, F₂/F₃, F₄/F₅

Nails in hole number:
1,2,6,7 /
11,12,16,17

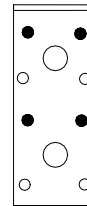
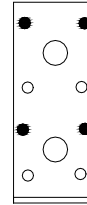

Timber to Concrete

F₁– column

Nails in hole number:
1,2,6,7 /
11,12,14,15,19,20

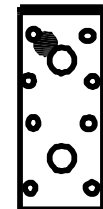
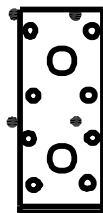

F₁ – purlin, F₂/F₃, F₄/F₅

Nails in hole number:
1,2,6,7 /
11,12,16,17

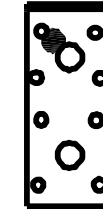
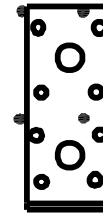

Angle Bracket 8624 and 8624 0070 1PLZ

Timber to Timber

F₁– column

Nails in hole number:
1,2/
10,11,14,15,17,18

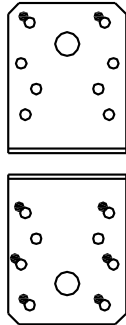

F₁ – purlin, F₂/F₃, F₄/F₅

Nails in hole number:
1,2,4,5/
10,11,14,15,17,18

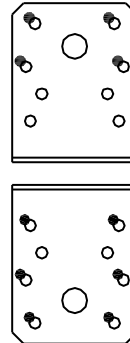

Timber to Concrete

F₁– column

Nails in hole number:
1,2/
16

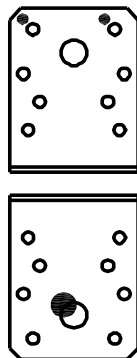

F₁ – purlin, F₂/F₃, F₄/F₅

Nails in hole number:
1,2,4,5/
16

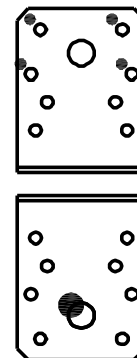

Angle Bracket 8625

F₁– column

Nails in hole number:
1,2,10,11 /
14,15,18,21,25,26

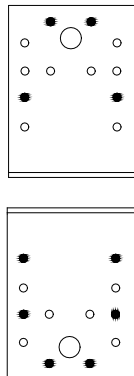

F₁ – purlin, F₂/F₃, F₄/F₅

Nails in hole number:
1,2,6,9,12,13 /
14,15,22,24

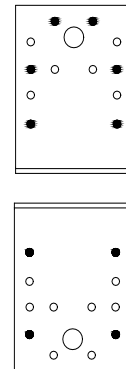

Angle Bracket 8625FH and 8625 90PL 1Z

Timber to Timber

F₁– column

Nails in hole number:
1,2, /
12,13,14,15,17,18,19,21,22

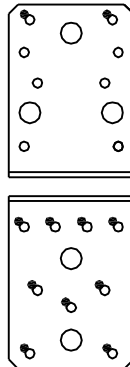

F₁ – purlin, F₂/F₃, F₄/F₅

Nails in hole number:
1,2,4,5,6,7 /
12,13,14,15,17,18,19,21,22

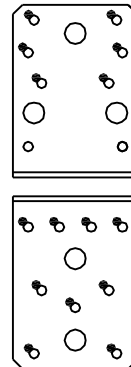

Timber to Concrete

F₁– column

Nails in hole number:
1,2, /
16

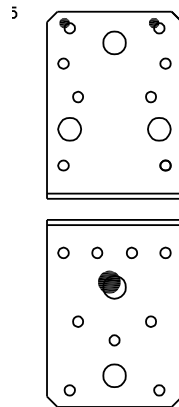

F₁ – purlin, F₂/F₃, F₄/F₅

Nails in hole number:
1,2,4,5,6,7 /
16

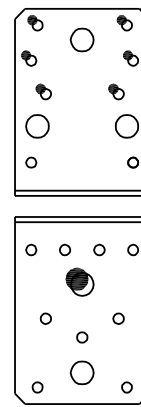

Angle Bracket 8626

F₁– column

Nails in hole number:
2,3,6,9 /
16,17,23,24,27,30

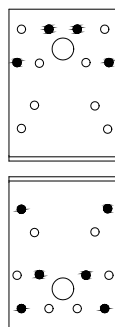

F₁ – purlin, F₂/F₃, F₄/F₅

Nails in hole number:
1,4,7,8,14,15 /
16,17,23,24

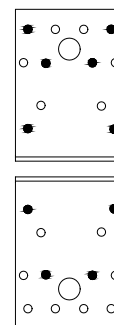

Angle Bracket 8626FH

Timber to Timber

F₁– column

Nails in hole number:
 1,2,6,7 /
 12,13,14,15,16,17,18,19,20,21,
 22,23,25,26

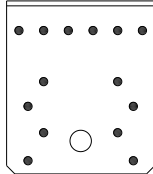
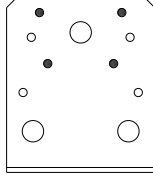

F₁ – purlin, F₂/F₃, F₄/F₅

Nails in hole number:
 1,2,4,5,6,7,8,9 /
 12,13,14,15,16,17,18,19,20,21,
 22,23,25,26

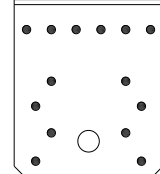
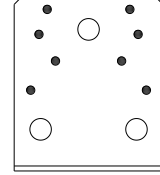

Timber to Concrete

F₁– column

Nails in hole number:
 1,2,6,7 /
 24

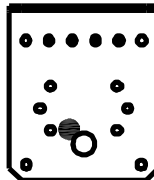
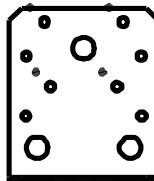

F₁ – purlin, F₂/F₃, F₄/F₅

Nails in hole number:
 1,2,4,5,6,7,8,9 /
 24

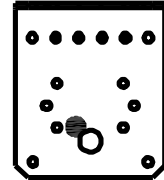
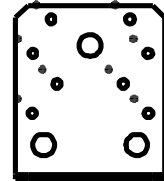

Angle Bracket 8626 10PL 1

Timber to Timber

F₁– column

Nails in hole number:
1,2,6,7 /
12,13,14,15,16,17,
22,23,27,28

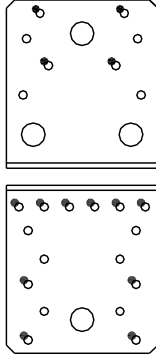

F₁ – purlin, F₂/F₃, F₄/F₅

Nails in hole number:
1,2,4,5,6,7,8,9 /
12,13,14,15,16,17,
22,23,27,28

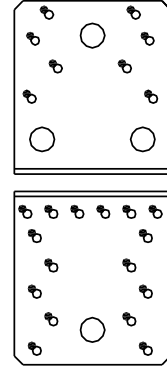

Timber to Concrete

F₁– column

Nails/Bolts in hole number:
22,23,27,28/
10,11

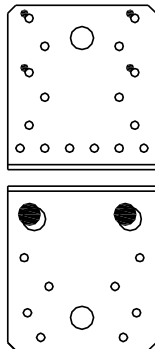

F₁ – purlin, F₂/F₃, F₄/F₅

Nails/Bolts in hole number:
18,19,20,21,22,23,24,26,27,28/
10,11

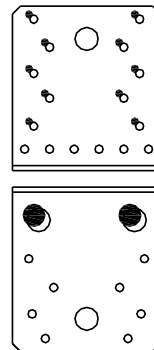

Angle Bracket 8627

Timber to Timber

F₁– column

Nails in hole number:
1,2 /
8,9,10,11,13,14

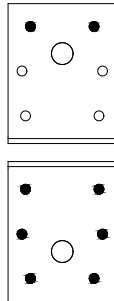

F₁ – purlin, F₂/F₃, F₄/F₅

Nails in hole number:
1,2,4,5 /
8,9,10,11,13,14

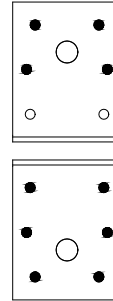

Timber to Concrete

F₁– column

Nails in hole number:
1,2 /
12

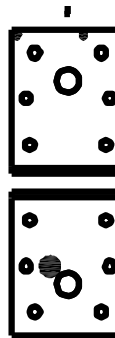

F₁ – purlin, F₂/F₃, F₄/F₅

Nails in hole number:
1,2,4,5 /
12

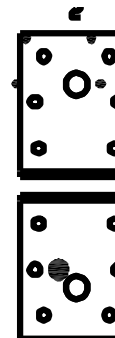

Angle Bracket 8628

F₁– column

Nails in hole number:
1,2,6,7,11,12 /
17,18,22,23,26,27,31,32

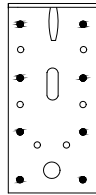
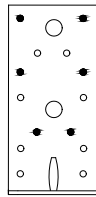

F₁ – purlin, F₂/F₃, F₄/F₅

Nails in hole number:
1,2,4,5,6,7,8,9,11,12,13,14 /
17,18,22,23,26,27,31,32

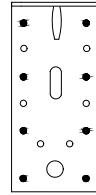
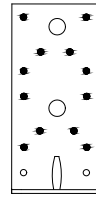

Angle Bracket 8628

F₁– column

Nails in hole number:
22,23,26,27,31,32/
10

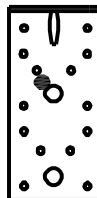
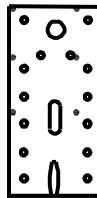

F₁ – purlin, F₂/F₃, F₄/F₅

Nails in hole number:
19,20,22,23,24,25,26,27,
28,29,31,32/
10

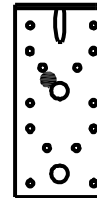
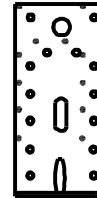

Angle Bracket 8629

Timber to Timber

F₁– column

Nails in hole number:
1,2 /
9,10,14,15

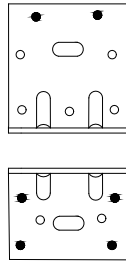

F₁ – purlin, F₂/F₃, F₄/F₅

Nails in hole number:
1,2,4,5 /
9,10,14,15

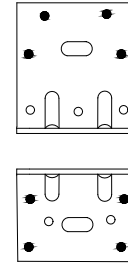

Timber to Concrete

F₁– column

Nails in hole number:
1,2 /
13

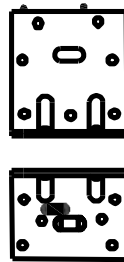

F₁ – purlin, F₂/F₃, F₄/F₅

Nails in hole number:
1,2,4,5 /
13



Angle Bracket 8632

F₁– column

Nails in hole number:
1,2,10,11 /
14,15,18,21,25,26

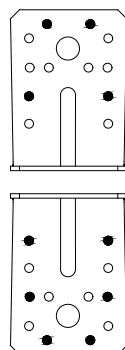

F₁ – purlin, F₂/F₃, F₄/F₅

Nails in hole number:
1,2,6,9,12,13 /
14,15,18,21,25,26

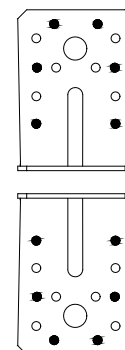

Angle Bracket 8632FH

Timber to Timber

F₁ – column

Nails in hole number:
1,2 /
12,13,16,17,18,19,21,22

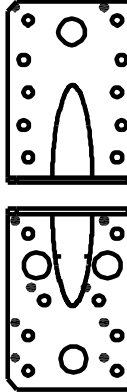

F₁ – purlin, F₂/F₃, F₄/F₅

Nails in hole number:
1,2,4,5,6,7,8,9, /
12,13,16,17,18,19,21,22

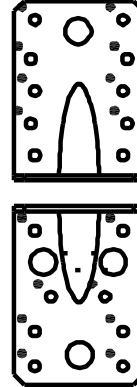

Timber to Concrete

F₁ – column

Nails in hole number:
1,2 /

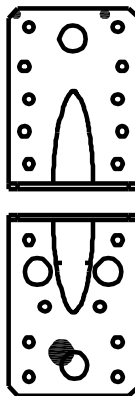

F₁ – purlin, F₂/F₃, F₄/F₅

Nails in hole number:
1,2,4,5,6,7,8,9, /

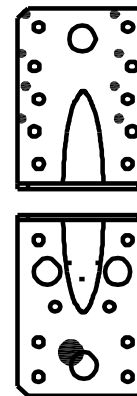

Angle Bracket 8632 90FH 1Z2.0

Timber to Timber

F₁– column

Nails in hole number:
1,2 /
12,13,16,17,18,19,21,22

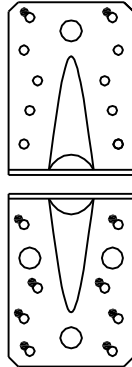

F₁ – purlin, F₂/F₃, F₄/F₅

Nails in hole number:
1,2,4,5,6,7,8,9, /
12,13,16,17,18,19,21,22

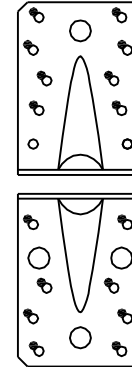

Timber to Concrete

F₁– column

Nails in hole number:
1,2 /
14,15

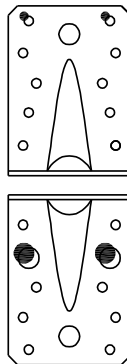

F₁ – purlin, F₂/F₃, F₄/F₅

Nails in hole number:
1,2,4,5,6,7,8,9, /
14,15

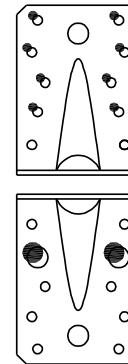

Angle Bracket 8633

F₁– column

Nails in hole number:
2,3,12,13 /
16,17,23,24,27,28,29,30

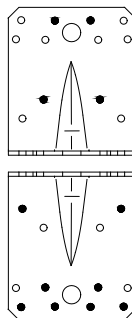

F₁ – purlin, F₂/F₃, F₄/F₅

Nails in hole number:
1,4,6,9,12,13 /
16,17,18,19,22,25,27,30

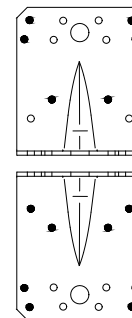

Angle Bracket 8633FH

Timber to Timber

F₁– column

Nails in hole number:

1,2,6,7 /

12,13,14,15,16,17,18,19,20,21,

22,23,25,26

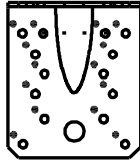
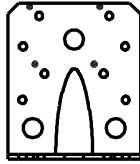

F₁ – purlin, F₂/F₃, F₄/F₅

Nails in hole number:

1,2,4,5,6,7,8,9 /

12,13,14,15,16,17,18,19,20,21,

22,23,25,26

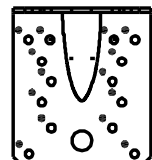
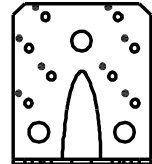

Timber to Concrete

F₁– column

Nails in hole number:

1,2,6,7 /

24

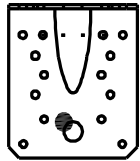
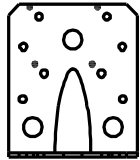

F₁ – purlin, F₂/F₃, F₄/F₅

Nails in hole number:

1,2,4,5,6,7,8,9 /

24

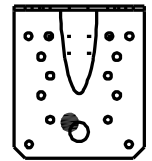
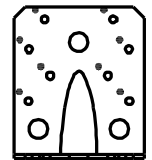

Angle Bracket 8633 10FH 1Z2.0 and 8633 10FH 1Z2.5

Timber to Timber

F₁– column

Nails in hole number:
1,2,6,7 /
12,13,14,15,20,21,25,26

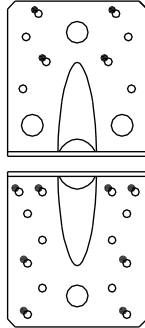

F₁ – purlin, F₂/F₃, F₄/F₅

Nails in hole number:
1,2,4,5,6,7,8,9 /
12,13,14,15,20,21,25,26

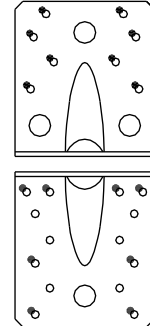

Timber to Concrete

F₁– column

Nails in hole number:
20,21,25,26/
10,11

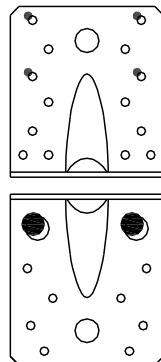

F₁ – purlin, F₂/F₃, F₄/F₅

Nails in hole number:
18,19,20,21,22,23,25,26 /
10,11

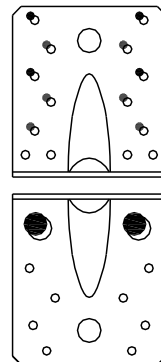

Angle Bracket 8634

F₁– column

Nails in hole number:

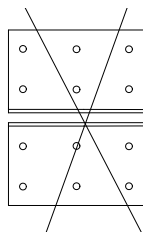

F₁ – purlin, F₂/F₃, F₄/F₅

Nails in hole number:
1,2,3 /
7,8,9,10,11,12

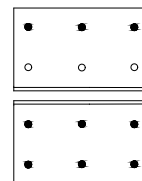

Angle Bracket 8635

F₁- column

Nails in hole number:
1,2 /
7,8,9,10,11,12

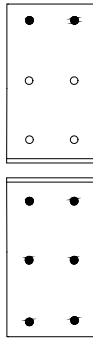

F₁ – purlin, F₂/F₃, F₄/F₅

Nails in hole number:
1,2,3,4 /
7,8,9,10,11,12

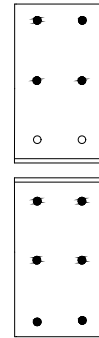

Angle Bracket 8636

F₁- column

Nails in hole number:
1,2 /
9,10,11,12,13,14,15,16

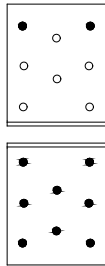

F₁ – purlin, F₂/F₃, F₄/F₅

Nails in hole number:
1,2,3,4,5 /
9,10,11,12,13,14,15,16

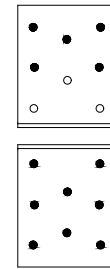

Angle Bracket 8637

F₁- column

Nails in hole number:
1,2,3 /
10,11,12,13,
14,15,16,17,18

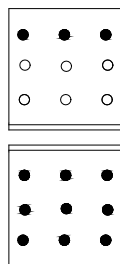

F₁ – purlin, F₂/F₃, F₄/F₅

Nails in hole number:
1,2,3,4,5,6 /
10,11,12,13,
14,15,16,17,18

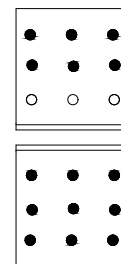

Angle Bracket 8638

F₁- column

Nails in hole number:
1,2 /
11,12,13,14,15,
16,17,18,19,20

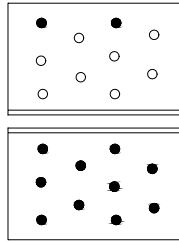

F₁ – purlin, F₂/F₃, F₄/F₅

Nails in hole number:
1,2,3,4,5,6 /
11,12,13,14,15,
16,17,18,19,20

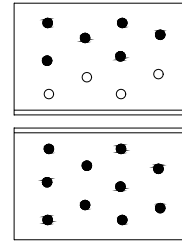

Angle Bracket 8640

F₁- column

Nails in hole number:
1,2,4,5 /
12,13,14,15,16,17,
18,19,20,21,22

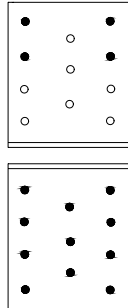

F₁ – purlin, F₂/F₃, F₄/F₅

Nails in hole number:
1,2,3,4,5,6,7,8 /
12,13,14,15,16,17,
18,19,20,21,22

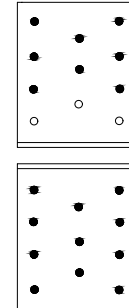

Angle Bracket 8641

F₁- column

Nails in hole number:
1,2,5,6 /
15,16,17,18,19,20,21,
22,23,24,25,26,27,28

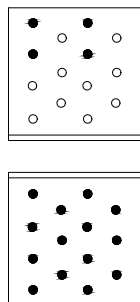

F₁ – purlin, F₂/F₃, F₄/F₅

Nails in hole number:
1,2,3,4,5,6,7,8,9,10 /
15,16,17,18,19,20,21,
22,23,24,25,26,27,28

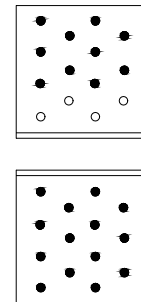

Angle Bracket 8644

F₁– column

Nails in hole number:
1,2,5,6,9,10 /
19 ÷ 36

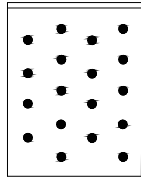
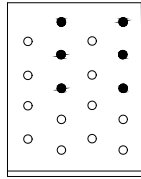

F₁ – purlin, F₂/F₃, F₄/F₅

Nails in hole number:
1 ÷ 14/
19 ÷ 36

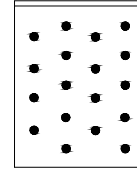
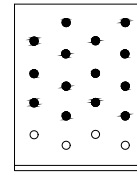

Angle Bracket 8645

F₁– column

Nails in hole number:
1,2,3,6,7,8 /
21,22,28,29,30,
33,34,35,38,39,40

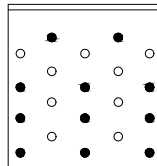
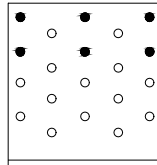

F₁ – purlin, F₂/F₃, F₄/F₅

Nails in hole number:
1 ÷ 18/
21 ÷ 40

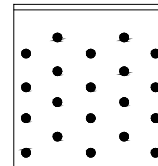
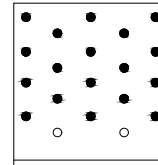

Angle Bracket 8654

Timber to Timber

F₁– column

Nails in hole number:
1,2,3 /
14,15,16,19,20,21

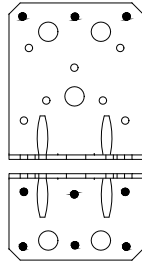

F₁ – purlin, F₂/F₃, F₄/F₅

Nails in hole number:
1,3,6,7,12,13 /
14,15,16,19,20,21

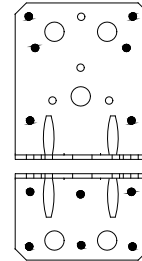

Timber to Concrete

F₁– column

Nails in hole number:
1,2,3 /
17 or 18

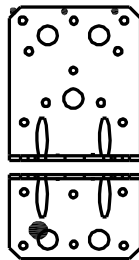

F₁ – purlin, F₂/F₃, F₄/F₅

Nails in hole number:
1,3,6,7,12,13 /
17 or 18

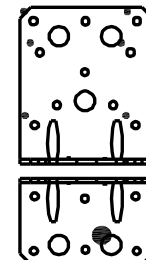

Angle Bracket 8655

Timber to Timber

F₁– column

Nails in hole number:

1,2,4,5 /
9,10,12,13

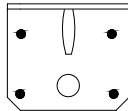
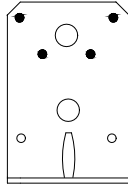

F₁ – purlin, F₂/F₃, F₄/F₅

Nails in hole number:

1,2,4,5,7,8 /
9,10,12,13

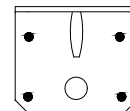
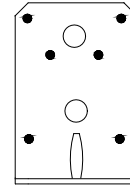

Timber to Concrete

F₁– column

Nails in hole number:

1,2,4,5 /
11

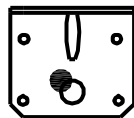
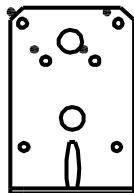

F₁ – purlin, F₂/F₃, F₄/F₅

Nails in hole number:

1,2,4,5,7,8 /
11

