

(DE) ACHTUNG!

Vor Beginn der Montagearbeiten lesen Sie bitte aufmerksam die Sicherheitshinweise!

(EN) WARNING!

Before assembling, please read carefully the safety instructions!

(NL) LET OP!

Lees de veiligheidsinstructies zorgvuldig door voordat u met de montage begint!

(FR) ATTENTION!

Avant le début des travaux de montage, prière de lire attentivement les consignes de sécurité

(IT) ATTENZIONE!

Prima di installare leggere attentamente l'avviso di sicurezza!

(ES) ATENCIÓN!

Antes de comenzar con los trabajos de montaje leer detenidamente los avisos de seguridad!

(PL) UWAGA!

Przed przystąpieniem do prac montażowych uważnie należy przeczytać wskazówki bezpieczeństwa!

(FI) HUOMIO!

Ennen asennustöiden aloittamista pyydämme Teitä lukemaan turvaohjeet huolellisesti!

(CZ) POZOR!

Než začnete provádět montážní práce, přečtěte si důkladně bezpečnostní pokyny!

(RU) ВНИМАНИЕ!

До начала монтажных работ внимательно прочтите эти указания по технике безопасности!

(GR) ΠΡΟΣΟΧΗ!

Πριν την διεξαγωγή της συναρμολόγησης διαβάστε προσεκτικά τις υποδείξεις ασφαλείας!

(RO) ATENȚIUNE!

A se citi cu atenție indicațiile privind siguranța, înainte de începerea montării!

(BG) ВНИМАНИЕ!

Преди да започнете работите по монтажа прочетете ВНИМАТЕЛНО инструкциите за безопасност!

(TR) DİKKAT!

Montaja başlamadan önce güvenli talimatnamesini titizlikle okuyunuz!

(HU) FLGYELEM!

A szerelési munkák megkezdése előtt figyelmesen olvassa el a biztonsági útmutatásokat!

(SV) OBS!

Läs säkerhetsanvisningarna noga innan du börjar med monteringsarbetena!

(HR) POZOR!

Prije početka montaže molimo pozorno pročitajte sigurnosne naputke!

(SL) POZOR!

Prosim, da pred začetkom montaže, zaradi varnosti preberete vas navodila, ki so priložena!

(SK) POZOR!

Pred tým ako začnete robiť montážne práce, prečítajte si dôkladne bezpečnostné pokyny!

(PT) CUIDADO!

Antes de iniciar os trabalhos de montagem por favor leia atentamente os avisos de segurança!

(BA) POZOR!

Prije početka montaže molimo pažljivo pročitajte sigurnosne upute!

(LT) DĖMESIO!

Norėdami saugiai ir teisingai sumontuoti šviestuv vadovaukitės šia instrukcija!

(ET) HOIATUS!

Enne monteerimist lugege ohutusjuhised tähelepanelikult läbi!

(DA) OBS!

Læs sikkerhedsinformationen nøje, før du monterer produktet!

(NO) ADVARSEL!

Les sikkerhetsinformasjonen nøye før du monterer produktet!

(LV) UZMANĪBU!

Pirms montāžas uzmanīgi izlasiet drošības norādījumus!

(SR) UPOZORENJE!

Prije početka montaže, pažljivo pročitajte sigurnosne upute!

(UK) ПОПЕРЕДЖЕННЯ!

Перед розбиранням, будь ласка, уважно прочитайте інструкції з техніки безпеки!

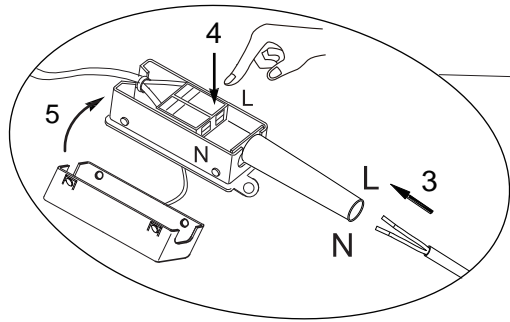
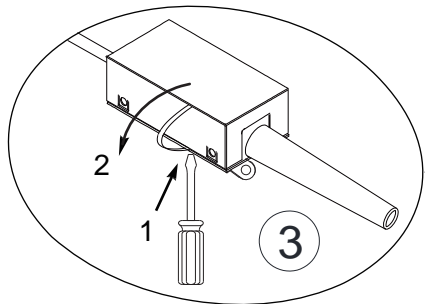
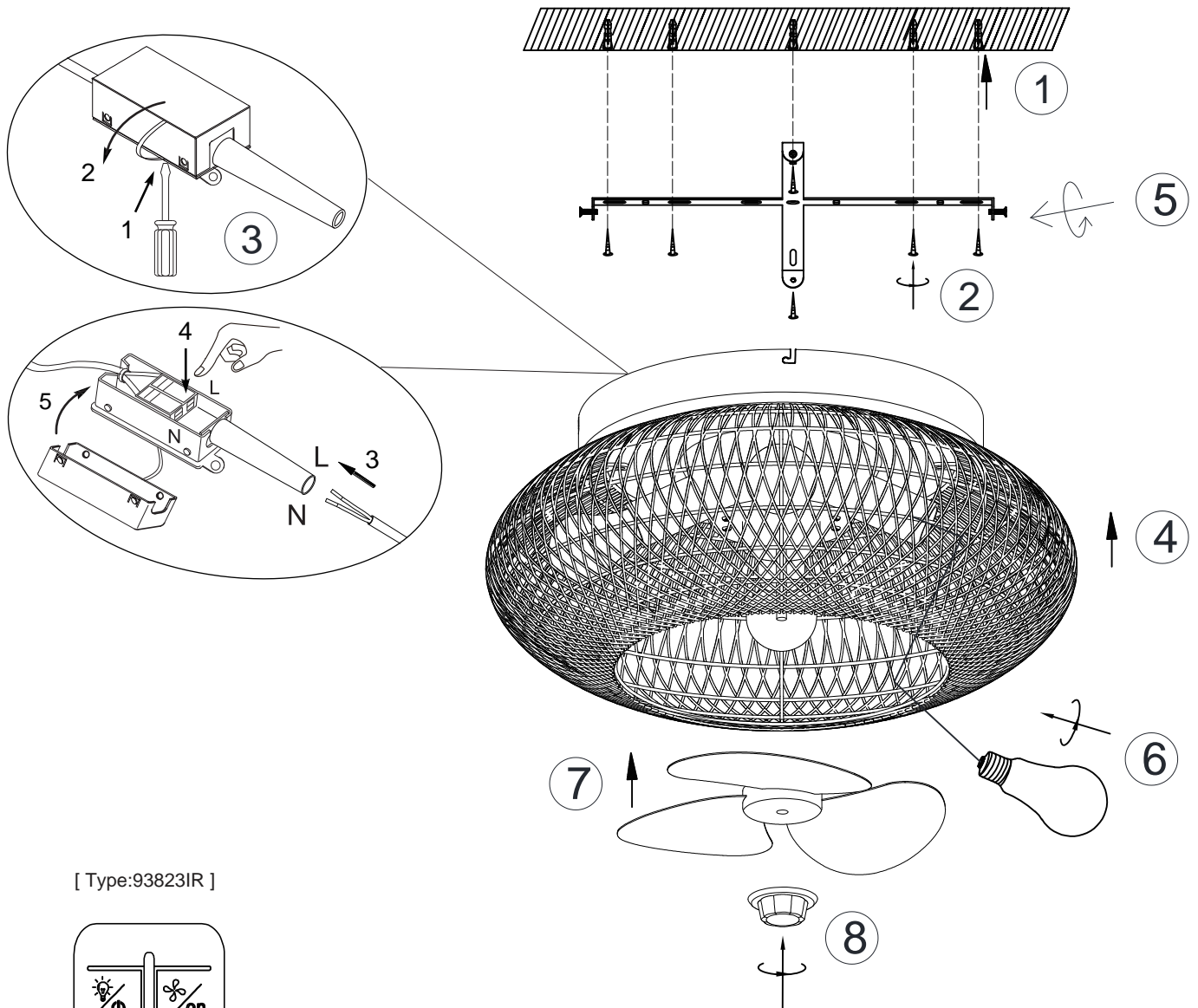

[Type:93823IR]

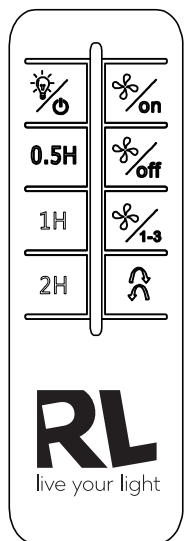

Infrared
Battery:2 x AAA 1.5V

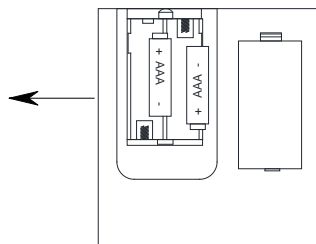

230V~50Hz, 4 x E27 max.10W
1 x FAN 15W

reality-leuchten.de/
R67302126

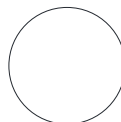

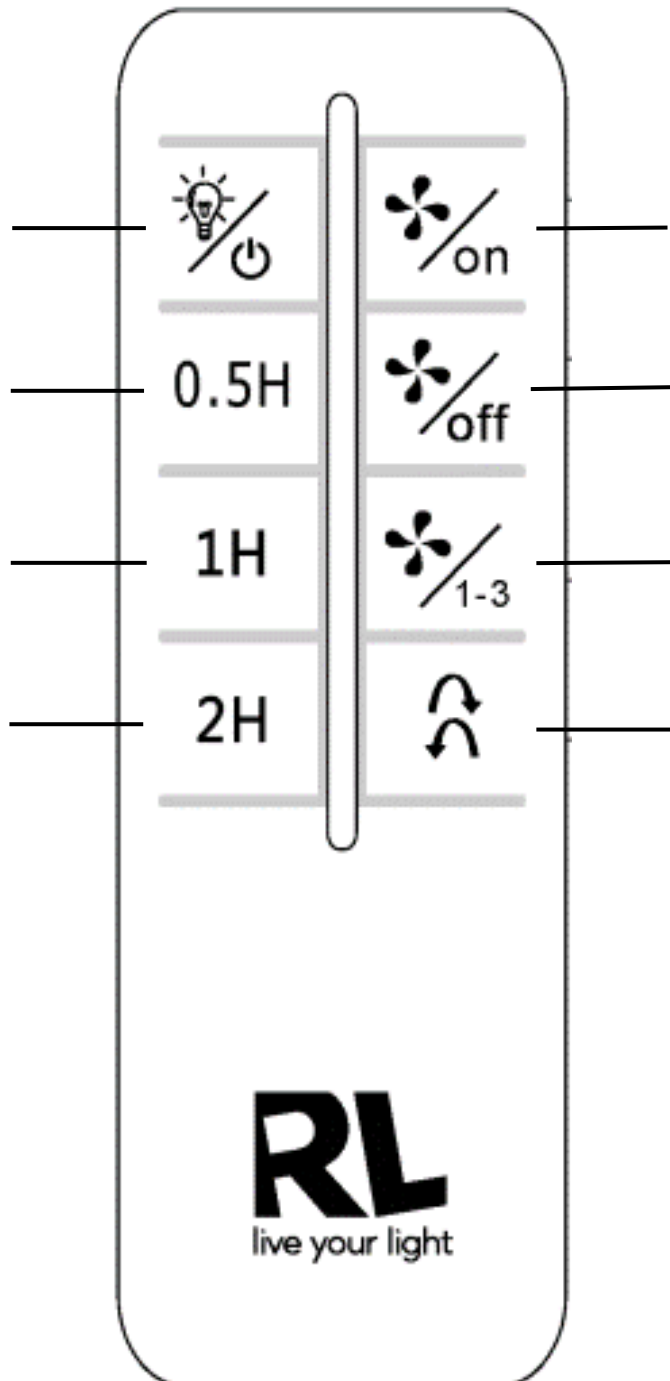

! " # \$ \$ % " #
& #
" ' " ")
' # \$ % % (")
" *

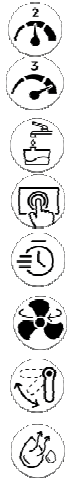

! " +
! " ,
! " - #
! " . ' ()
! " . (# &
! " / (# &
& ' " 0
! " (" 1
"

\$ \$! " 3 \$
\$! " (# 1 ! "
&) \$
\$ \$ <

%=: 0\$; ' 2 -
966>

9 : ;
+ . 2 3 4& ,6 7 8
, . 2 3 4& 56 7 8
? . 2 3 4& + 8
B : 5 : ; &
A ! "
E " 4- 8 : & " 4\$ 8

; ? @ + A @ 96- : 3 9B-
\$ " ; + (5 B 4 D : 8 :-
& \$ ' 4* 8 ; B, (C # 4 8
7 @ & ; , C (9 ? D :
\$; 6 (B -
7 @ 4* \$ 8 ; + (B E :

' + ! * # ' ' ' & * * ' M M ' * & * M ' ' / " ' * ' 7 ' (" ' * * ' "



" + " " , " " ' (* " " * * * " @ *

\$

' (' ' " "

-

#

)

=:0%.;

=

' 2: '966>

)

9 : ;

+

. 4 ,6 8

,

. 4 56 8

?

. 4 + 8

B

:5 : ;&

A

" , "

E

4 * 8 : & 4 * 8

;?@ +A @ 96- : 3 9B-

#

* ;+(5B 4 D: 8:-

&

4' 8; B,(C #4 8

7

@ ;,C(9? D:

7

@ ;6(B -

7

@ 4' 8; +(BE :

. ! / ! & * & 0
= ' *
' ' F ' K \$ ' S ' T % S
' ' S ' ' U ' ' U
' ' @ ' V ' ' *
' ' V ' ' ' (F
F ' ' F



' ' +
' ' ,
' ' 'S ' S
' V F ' ' V (F ' S
' ' S ' S
' ' S S (F '
' F
' ' S S (F

1
=
= F T * (' * ' '(
| ' * ' U 7
|

! -
/=:/33; ' * 966>
' \$ *

! -
9 : ' ;
+ 3 S ' 4 ' ,6 8
, 3 S ' 4 ' 56 8
? 3 S ' 4 ' + 8
B : 5 : ' ; &
A ' ' ,
E 7 V 4 8 : 4 8
1 %

; ? @ + A @ 96 - : 3 9B -
& ; + (5 B 4 D : 8 : -
= ' T 4 ' 8 ; B , (C # 4 8
7 @ 3 * K ; , C (9 ? D :
\$; 6 (B -
7 @ & 4 ' 8 ; + (B E :

5 " ! 6!*7 34 4 +*8 7 ! " " "#
 \$ ' W (X X ' Y X Z '*
 [' \$[' ' Y
 \ ' Z [* \ Y W
 [Z X X '
 X ' Z ' * * \ Y \]
 S X S(S \ - *
 X *Z' ' ' S \$' \
 \ [\ % * ' S
 : * \ [' * ' Y \$ \
 Y * \ [X X] *
 ' Y \ ' * % *
 ' S : * \ [' * ' Y



0 \ ' + SX '
 0 \ ' , SX '
 0 \ ' Y X '
 0 \ ' X * W (X S SX
]
 0 \ ' *Y N
 0 \ ' *Y *(S X ' * * *
 ! [Y X ' Z
 0 \ ' *Y X ' (S ' Y
 [

5 1 ! 9
 Y \ [ZX ' S ' S
 = \ [WZX ' S(* ' YW
 < Z X WZ ' ' [[S 7 \ Z ']' = X
 Z * \ Y'
 - S '] * X Z ' [WZ

2! 3 4 3 !

-^:~^;\ [* [\
 ' [Y * Y 966> * W ' *\

2! 3 4 3 !

9 -[:-[;
 + 3 * 4 [\ Y' ,6 8
 , 3 * 4 [\ Y' 56 8
 ? 3 * 4 [\ Y' + 8

B : 5 -[:-[;-

A 0 \ ' , SX '
 E [4' 8: ' 4' 8
 *

S ;?@ +A @ 96-:3 9B-
 -'S[* W ;+(5B 4 D: 8:-
 * 4 X ' 8; B,(C #4 8

7 ' [*Y W ;,C(9? D:
 S W ;6(B-
 7 'Y WZ 4 X ' 8; +(BE :

0 0 0 *// +! * " % > #
 * ' cd ' V / d K U (*U
 K K ' e c c f / * fgU d K U d
 ' U * ' eU gK d K T e d \$ *V' *U K * K
 U* U (K h cV U K ' &g *U K
 U* U U h * K ' ' e U (f V d K U d \$ d K
 * ' K' e* K' e c \$ K ' e c c *U K U
 T * K U V* d d U(f fh h f * ' d h
 VU h ' e ci ch



<eU U V+ i K h K 'd



<eU U V, i K h K 'd



<eU U V U V f c V U U



<eU U* h ' * (h fj* i h U



<eU U V c c



<eU U V cU (V fj* h ' V ' e c K



V V K



<eU U V ' K c V U(K' e 'UV cK U

) !? /! ""

\$ eUf * fV K' e d c '

= eU U ' V * fV K' e d (* ' e c U
 h i . h V ' 0 f* ch ')

f* g 'c U' V

<! +* = * * " 0 % 00/

/=:/33;\$ d * ' :T' d '

' K ' k U 966> * &g 'e U U*

<! +* = * * 0 % 00/

9 <: '; \$d

+ 3 c c 4 V ' ',6 V 8

, 3 c c 4 V ' ' 56 V 8

? 3 c c 4 V ' '+ V 8

B :5 <: '; 3 g

A <eU U V, i K h K 'd

E <'d h 4 U' 8: 'e h 4 U' 8

% @ *

a h h ;?@ +A @ 96-:3 9B-

;+(5B 4 D: 8:-

I j K h V ;B,(C #4 8

7 @ 'i V ;,C(9? D:

eU ' U f ;6(B-

7 @ ; +(BE :

WGFKCNVKJH CXGGK DNGSRYZCG JDJIGFFJDKC ~~PGQSEJFEDJGXEKC~~\GDPJX \Gf
mno pqrstps ustvw xntpqpyoz{nv zls}ns } ~noz•|p on€or{|p •,oufs ,,}...tx{n{fpp z}st†r{
ro)n{zwt†ns pqrstps z ...xu,n ...yps|{ on€oroz „ts,nypˆs},o†o p „ts,nyouuo†o o~oyxroz{upw
%orys} n{,o†o ...xu,n{ }...y{Špz{†ns z †oyor},o† {r|pup}ny{fpp †o CEs }{|os ,|}{sn}w z}s€
~{n{ys, p ...sysq{ywCE{s}|•€ {,,x|xtwnoyoz(z,tˆsuo•€ z ,o |...ts,n ...o)n{z,p •}s ~{n{ys†,p p
...sysq{ywCE{s}|•s {,,x|xtwnoy• rotCEu• z•up|{nv}w pq pqrstps ...sysr st†o ro)n{z,o† z ...xu,n
...yps|{ on€oroz Žtpsy• o~wq{u• ~s}...t{nuo q{~py{nv }n{y•s ...yp~oy• •n{y•s ...yp~oy• ˆ}{no
}orsyCE{n ,ou•prsfup{tvu•s tpˆu•s r{uu•s Žtw }o~}nzs uuo† ~sqo...{uo}np(...oCE{tx†}n{(
...o|upns(ˆno ,{CEr† ,ousˆu•† ...otvqoz{nstv us}sn onzs)nzsuo}nv q{ xr{tsups r{uu•€ u{
}n{y•€ ...yp~oy{€(...ortsCE{p€ xnptpq{fpp



'yp~oy p|ssn + }nx...sup ...yopqzornstvuo}np



'yp~oy p|ssn , }nx...sup ...yopqzornstvuo}np



'yp~oy o}u{su s|,o}nv• rtw zor• rtw xzt{CEsupw zoqr x€{ z ...o|s'supp



'yp~oy o}u{su }su}oyu•| rp}...tss{(ˆno o~s}...sˆpz{sn xro~}nzo u{nyo†,p



'yp~oy p|ssn •xu,fp• n{†|sy{



'yp~oy p|ssn •xu,fp• ,{ˆ{upw(o~s}...sˆpz{•x• zsunptwf• oru ozys|suoo } ...ozoyono|
zsunptwnoy{



"v zsunptwnoy{ |oCEuo us|uo†o u{,toupnv



'yp~oy p|ssn •xu,fp• xzt{CEsupw zoqr€{ z ...o|s'supp(ˆno }oq r{sn ro...otupnstvu•† „•s,n
o€t{CEsupw

^EQEFCV BJ KG[FCPG IGQJBE

•s z{n{zwt†ns z q{pnux• ysŠsn,x ...{tvf• p ,{ps2tp~o ...y sr|sn•
•s x,t†r{z†ns us ...yp~oy ,{ps2tp~o ...ysr|sn•(u{...yp|sy (ˆ}{np orsCEr•
•o~t•r{†ns o}noyoCEuo}nv ...yp u{tpˆpp rtpuu•€ zoto} "up |o† xn ~•nv znwuxn• z ...yp~oy zoqrXŠu•|
...ono,o| •o~t•r{†ns ~sqo...{uos y{}}nowups
~y{upns ...y{zpt{ ns€up,p ~sqo...{uo}np p yx,ozor}nz{ ,,,ø...tx{n{fpp rtw ...o}tsrx•s†o p€

ABCDEF CG HEIJKL DMGKCN OFCPE IGQ BRNOKE ~~SCDRBHECUNFG~~BCV

/=:/33 4•—:•™—~8; •,tˆsup s p z•,tˆsup s x}nyo†}nz{
'o}ts ...oznoyuo†o z,tˆsupw xyozsuv o}zs'supw 4wy,o}nv8 x)n{u{ztpz{sn}w u{ 966> •}s ...ysr•rx'ps
u{nyo†,p }~y{•z{•n}w

ABCDEF CG HEIJKL DMGKCN OFCPE D BRNOKJX ~~SCDRBHECUNFG~~

9 /:/ ; lzsn

+ "xu,fpw n{†|sy{ 4zsunptwnoy on,tˆ{sn}w ˆsysq ,6 | puxn€
, "xu,fpw n{†|sy{ 4zsunptwnoy z•,tˆ{sn}w ˆsysq 56 | puxn8
? "xu,fpw n{†|sy{ 4zsunptwnoy z•,tˆ{sn}w ˆsysq + ˆ{ }{8

B : 5 /:/ ; #sunpt{noy

A 'yp~oy p|ssn , }nx...sup ...yopqzornstvuo}np

E æszsy} 4qp|uww ,,}...tx{n{fppw8 : z...sysr 4tsnuwvx,n{fppw8
_G[FC\GDPCG SEFFLG

•o|pu{tvu{w |o'uo}nv; ?@ +A @ 96- : 3 9B-
•nop|o}nu{w qu{ˆp|o}nv x}tx†p; +(5B 4 D: 8:-
šyozsuv qzx,ozo† |o'uo}np zsunptwnoy{; B,(C #4 8
'{,} y{€or zoqrXŠuo†o ...ono,{ zsunptwnoy{; ,C(9? D:
musy†o...onys~tsups z ysCEp|s oCEpr{upw; 6(B -
'{,} },oyo}nv zoqrXŠuo†o ...ono,{; +(BE :

WGFKCNEKJH`K CXE DNGSFCKG [EHEPKGHCDKCE+BSPEQFC FE D]GXEKCFVCV`

'yoxr,nĐn us nyw~z{ r{ }s pq€zĐytw q{sruo } ~pnozpnēn...{rĐfp • ,y{w u{ s,}...to{n{f pouupw |x ...sypor zpu{tp ...ysr{z{fns ...yoxr,n{ z ...xu,Đn q{ }Đ~pyfuyf,tpy{us u{ on...{rĐfp on sts,nyp`ŝ},o p sts,nyouuo o~oyxrz{us N{ ...ozs`ŝ puoy| {fpw }s o~Đyusns ,Đ| ,o|...snsunu{n{ o~`pu},{ {r|pup}ny{fpw 'oz{ }s onu{ }w p q{ z}p^,p ~{ nsypp ptp {,x|xt{noyp(,opno |o{`n r{ ~Đr{n z,t^sup z o~€z{n{ u{ ro}n{z,{n{ 'ysrp ...ysr{z{ us z ...xu,n{ q{ }Đ~py{us u{ on...{rĐfp z}p^,p }|suw|p ~{nsypp ptp {,x|xt{noyp nyw~z{ r{ }Đr {n pqz{rsup 'Đy{ozf pns }{ rĐCEup r{ ...yps|{n o~y{n{uo}n{ypw xysr ~sq...t{n{uo •n{ypns xypr`ŝ}no }ĐrĐyCE{n ^xz}nzpnstup tp^up r{uup •Đz •{Š punsys} •p pu•oy|py{|s(`s onfozoyuo }n u{ ,y{fupw ...onys~pnst s r{ pqnyps r{uupns on }n{ypns xysrp(...ysru{qu`sup q{ pq€zĐytw



šysrĐn y{q...ot{t{ } + y{qtp^up }ns...sup u{ |o'uo}n



šysrĐn y{q...ot{t{ } , y{qtp^up }ns...sup u{ |o'uo}n



šysrĐn p|{ zorsu ysqsyzo{y q{ ozt{CEuwz{us u{ zĐqrx€ z ...o|s'supsno



šysrĐn s o~oyxrz{u }Đ} }suqoysu rp)...tsf(,osno ...oqzotwz{ xrøsu pq~oy u{ y{qtp^upns u{ }nyoƒ,p



šysrĐn y{q...ot{t{ } •xu,fpw n{f|sy



šysrĐn y{q...ot{t{ } o}fptpy{` •xu,fpw(,owno ...oqzotwz{ zĐynw }s rzpCEsups u{ zsunpt{noy{ ...yp sruozys|suo zsunptpy{us



Òt{z{n{ u{ zsunpt{noy{ |oCEs r{ }s u{,t{uw z o...ysrstŝ u rp{...{qou



šysrĐn y{q...ot{t{ } •xu,fpw q{ ozt{CEuwz{us u{ ...o|s'supsno(,owno ro...ypu{ }w q{ ro...Đtupnstsuo €t{CEr{` s•s,n

^PEQEFCV QE IGQJBE

- s ...Đ€{fns ...ysr|snp ptp ...yĐ}npns }p ...ysq q{`pnu{ŝŝn,{
- s ...o{n{zwfns ...ysr|snp(,fno u{...yp|sy rys€p(zĐy€sx{
- up|{z{fns ...yp rĐttp ,o}p •ĐqrxŠupwn ...ono, |oCEs r{ p q{ }x`s •...{qz{fns ro}n{nĐ^u{ rp}n{ufpw
- Đ€y{uwz{fns x,{q{upwn{ p pu}nyx,fpns q{ ~sqo...{uoln}p{txyuo |w}no q{ ...o2u{n{nĐŠu{ x...onys~{

ABCDEF CG PEP HEIJKC JDMGKNGFCGKJ IGQ SCDRBFEDMNGFCG

/=:/33 4•— :ÓÑ— 8; "zsnstsupns }s z,t^z{ p pq,t^ z{ u{...Đtuo
•tsr ,{no }s z,t^p onuozo(wy,o)nn{ s u{ }nyosu{ u{ 9 66> •}p^,p ...ysrpŠup u{ }nyoƒ,p }s uxtpy{n

ABCDEF CG PEP HEIJKC JDMGKNGFCGKJ D SCDKBFEDMNGFC

9 •t^z{us:Óq,t^z{us; |zsntpu{
+ "xu,fpw n{f|sy 4zsunpt{noyĐn }s pq,t^z{ }tsr ,6 | puxnp€
, "xu,fpw n{f|sy 4zsunpt{noyĐn }s pq,t^z{ }tsr 56 | puxnp8
? "xu,fpw n{f|sy 4zsunpt{noyĐn }s pq,t^z{ }tsr + ^{ } }8

B : 5 •t^z{us:Óq,t^z{us; #sunpt{noy

A šysrĐn y{q...ot{t{ } , y{qtp^up }ns...sup u{ |o'uo}n

E œ{~on{ u{ q{rsu €or 4y{~on{ ...ysq qp|{n{8 : y{~am{ ...ysrsu €or 4y{~on{ ...ysq twnoi
_G[FC\GDPE CF%oJHXETCV

- o|pu{tu{ |o'uo}n; ?@ +A @ 96- : 3 9B-
Ó,)...to{n{f pouu{ }noƒuo}n; +(5B 4 D: 8:-
•pzo u{ qzx,oz{n{ |o'uo}n u{ zsunpt{noy{; B,(C #4 8
>{,}p|{tsu rs~pn u{ zsunpt{noy{; ,C(9? D:
—ou}x|{fpw u{ susytpw z ysCEp| u{ fonozuo}n; 6(B -
>{,}p|{tu{ },oyo}n u{ zĐqrx€; +(BE :

, 0 - • * 0 " * 0 0 *
 K V V K V U K K KK
 K K T* UVV VS Ý*P
 1K* (K P*) P K) V V 0
 V UV S) V S V 7 P
 T*) P V (P Ý*P P) K
 K K U* K K K KK K
 Ú K K K* ((K VS P
 V P K K K V S) KKK



K K K))P * U K



K K V))P * U K



K K K P*K U K K U V



K K K P K' P * P (P K))P V UV
 K V UVV



K K P U P S



K K VS S (*Ý S P K V
 P VV P K



V * K K K * U S



K K K U P S (V*V K U P Ý P V

) 0 " %
 = * K P V V (**V
 = V ('K V V K K
 ß T ** # U * K V . P V V

à) V K K UV *)P K

, 0! 0 % • % 0 0 0

:1%; V' * 2: ' V
 % K ' V) P V' 966>2 K P V U & P P V UV
 V UV

, 0! 0 % • 1 0 0 0

9 *V V: ;) Ý
 + % P U P S4 V ,6' V ' 8
 , % P U P S4 V 56' V ' 8
 ? % P U P S4 V +S V ' 8

B :5 *V V: ;& V
 A K K ,) P * U K
 E 3 U 4K S8: P 4 V S8
 • 0 1

. * U K ; ? @ + A @ 96- : 3 9B-
 Ö K K ; + (5 B 4 D : 8 :-
 & V 2 * U K ; B, (C # 4 8
 7 @ V V 2 K) V ; , C (9 ? D :
 V K K S ; 6 (B -
 K K ; + (B E :

; - * ; ! ' #
 " á ") á % " * " ' á
 " ") 7
 " ") 4 " * 8
 á) 4 " * 8 á " !
 ' ' â) " * " =) " "
 ") á ' "

2 " á "
 3 " "
 4 " á)
 5 " ") ' " "
 6 " ") " "
 7 " ")) *"
 8 " "))
 9 " "))
 0 " "))
 1 " "))
 2 " "))
 3 " "))
 4 " "))
 5 " "))
 6 " "))
 7 " "))
 8 " "))
 9 " "))
 0 " "))

\$) á) á
) á á " ' á "
 &) á á) 0" á ' á) á

\$' ")
) ! *;









â: &; ' " : "
 =" " * ã 966 > * ã "

) ! *;
 9 á: ; *
 + . 4 " " ,6 8
 , . 4 " " 56 8
 ? . 2 4 " " + 8
 B : 5 á: ; 3 "
 A " , "
 E) 4 8: á) 4 8

\$)) ; ? @ + A @ 96- : 3 9B-
 " ; +(5B 4 D: 8:-
 3 " * á ; B, (C # 4 8
 7 @ ") ; , C (9? D:
 \$)) \$ # 2 " ; 6(B -
 7 @ ; +(BE :

* ' ? * + ! *
* * Z ' 0
* c c ' 0
c * f ' Z ' % *
* c ' ' \$ * *
* . f '
' (* *
' ä * * * *

! " #
* ' *
* * * * 7 ' *
* ' * * *
' * * * * ' * g *
ä * ' \$ ä * c f * *
** * *

-  0 ä * + c
-  0 ä * , c
-  0 ä * ' f * ' *
-  0 ä * * ' * * * Z c '
-  0 ä * * * c
-  0 ä * * * (* Z * *
-  ! f c * *
-  0 ä * * f * ' * (g ' ä *

= ' c ' ' g
= * * ' (' * '
' f f *

\$ c * ' * Z

2! * * * ! * ?

01 a0â =/:%\$1 a0â =/;\$ * * ' '
= ' * c * (' g 966 > * c * : * c * * \$ ' ' Z * ' c

2! * * * ! * ?

9 0 * c : % * c ; \$ *
+ 3 * * c 4 ,6 8
, 3 * * c 4 * c * 56 8
? 3 * * c 4 * c * + 8

B : 5 0 * c : % * c ; &
A 0 ä * , c
E f * 4 8 : f * ' * 4 * 8
?

a c * ; ? @ + A @ 96 - : 3 9B -
* ; + (5 B 4 D : 8 :-

* c ; B , (C # 4 8

7 ' ; , C (9 ? D :

g * * f c * ; 6 (B -
7 ; + (B E :

* + ? !
 % * c ' * ' *
 ' * ' ' * c ' . *
 * c & * *
 ' ** c * ' <
 ' (* *

? #
 ' % ' * f * *
 c ' / * c
 * * (' *
 ' c ' * \$ '
 ' g * (* c '



= ' + c ' * c



= ' , c ' * c



= ' f * '



= ' * ' * (c c



= ' * c



= ' * * (c * * * ' c *



! * *



= ' * f * ' (' ' c

= ** ' ' gc g
 = ' ' ** ' (c
 # ' (c . ' c 0'g * *

0'g * ' *g *

2! * ? * ! * *

&1 / : % < 1 / ; c * ' ' ' f : *
 1 * ' ' f (966 > & ' ' *

2! * ? * ! * *
 9 & ! : % ' ; \$
 + 3 * c 4 ' ' , 6 8
 , 3 * c 4 ' ' 56 8
 ? 3 * c 4 ' ' + 8

B : 5 & ! : % ' ; &

A = ' , c ' * c

E f * 4 * 8 : ' * 4' * 8

? !

= c ; ? @ + A @ 96 - : 3 9B -

\$; + (5B 4 D : 8 -

= c ' * ; B , (C # 4 8

= * c * ' * ; , C (9 ? D :

* * ' ' * ; 6 (B -

= * c * ; + (B E :

0 ! * > æ ' h ' +! " 0" > #
 &h ' c U* f f
 * V h h U /
 * 'U g T . K' U*' g K V (K
 çf æ Tc æ V &g èK K V æ'
 U K V K * T' U ' ' æ h' c
 \$ K' c c *T K KT* & V* ' j* (f fh
 h' fU è* ' h T* h ' c c h V

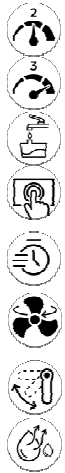

U * ' * + ch h h 'j
 U * ' * , ch h h 'j
 U * ' * V f c
 U ** h h ' * (c fj * h h ch U
 U * ' * c c
 U * ' * V (V fj * h' V ' Tc * V
 V V Vjæ
 U * ' * c (V' ' 'U K

) ! ? % ! " "
 I T f * f ' '
 = 'U * V * f ' ' (' c
 / ' ' h . çf æ K' T f * cT æ
 &g 'c K' V * ' T æ
 <! + * " % 0 ?
 < :&_ ; \$ T' ' : '
 " ' k U 966> * &g ' V *T *T
 <! + * " > 0 ?
 9 < :& ' ; \$
 + 3 c c 4 V ' ' ,6 T 8
 , 3 c c 4 V ' ' 56 T 8
 ? 3 c c 4 V ' ' + V 8
 B : 5 < :& ' ; & V
 A U * ' * , ch h h 'j
 E 4 V' V 8 : ' 4 V ' V 8
 % 0
 7 h h ; ? @ +A @ 96- : 3 9B-
 ; +(5B 4 D: 8:-
 I j K h V ; B, C #4 8
 7 @ h æ' V ; , C(9? D:
 U ' f ; 6(B-
 7 @ h æ ; +(BE :

* ' +! ! "#
 / * ' * * Z
 ' ' * * f c ' * * * * * 7
 ' * c f 'Z * % f * ' * *
 * * * c ' \$ * * ' * * *
 ' * g * ' ' * * ä *
 \$ ä * c f * * c ' < * (* *
 ** * ' ä * * f



0 ä * + c



0 ä * , c



0 ä * ' f * ' *



0 ä * * ' * * * Z c '



0 ä * * * c



0 ä * * * (* Z * *



! f c * *



0 ä * * f * ' * (g ' ä *

!

= ' c ' ' g g
 = * * ' (' * ' (ä *
 # ' f f * * *

\$ c * ' * Z

2! * * ! * ?

01 a0â =/:%\$1 a0â =/;\$ * * ' ' * c : * c
 = ' ' * * ' g 966 > * c * \$ ' ' g *

2! * * ! * ?

9 0 * c :% * c ;\$ *
 + 3 * * 4 * c * ,6 8
 , 3 * * 4 * c * 56 8
 ? 3 * * 4 * c * + 8

B : 5 0 * c :% * c ;&

A 0 ä * , c

E 4 8 : ' * 4 * 8

?

a c * ; ? @ + A @ 96 - : 3 9B -

* ; + (5B 4 D : 8 :-

= * c ; B, (C #4 8

7 ' ; , C (9 ? D :

g * * f c * ; 6 (B -

7 ; + (BE :

*; + ; * #
' & " *
*"" ' 0 ' *
\$ * ' (è
*"" " * è * ' *
è & * ' *
' (è" * '
*""



\$ + è
\$, è
\$ ' è
\$ ' (è
\$
\$ (è *
& ' " ""
\$ (" *
2 *
" è ' * è
b * ' * 4 8
* ' * 0 è ' è *
\$" è * * *
* !

\$%\$\$:&b a ; " : " *
" ã 966> 1ê "

* !
9 \$: " * ; &
+ . 4 " * , 6 " 8
, . 4 " * 56 " 8
? . 4 " * + " 8
B : 5 \$: " * ; 3"
A \$, è
E " 4)) 8 : è 4 f 8

; ? @ + A @ 96 - : 3 9B -
.ê "" ; + (5B 4 D : 8 :-
& ; B , (C #4 8
7 @ ; , C (9 ? D :
; 6(B -
7 @ 0 ; + (BE :

š á + ' !' # ' 'á
(á * 'á
' á ' (á ó * (ô
" 3 ' ' 3 " (!
'ô 3 'ó ('á " (



" + 'ó



" , 'ó



"



" ó (ô ó



"



" (ô ó



& ô* ó



" (ô ô

\$

ó (@ ó ('á "

0 á á ô ó

/'

) " * *

.õ= :\$ 01; ó :
=á ó ã' ã 966> ã ã ã

) " * , ! * *

9 . :3 ;

+ . 4 ,6 8

, . 4 56 8

? . 2 4 + 8

B : 5 . :3 ;&

A " , 'ó

E ô 4 8: ô 4 8

!"

\$ ô ;?@ +A @ 96- : 3 9B-

= ó ;+(5B 4 D: 8:-









;B,(C #4 8

7 ô ; ,C(9? D:

\$ ô ;6(B -

7 ; +(BE :

' * +! ! ~ "#
 / *' f * Z
 f c ' ' * * * * 7
 ' * ' f 'g ' % f * ' *
 * * *c ' \$ * * ' * * *
 ' g ' f * 'g
 7 c ' < * (* * *
 ä * * Z f * ' \$ ä * c f *

 ' + c
 ' , c
 ' ' f * ' *
 ' * ' * * * Z c ' g *
 ' * * c
 0 ä * * * (* Z * *
 ! f c *
 ' * f * ' * (g ' ä *

) !
 = ' c ' ' g g
 = ** ' (' ' (' ' g
 # ' \$ ** f f * *

\$ c * ' * Z

2! * * ! * ?

01 a:%\$1 a;\$ * ' *c* *c* ' ' *c * ' g
 * 966> \$ ' ' g *

2! * * ! * ?

9 0 * :% * ; lzsnt
 + "xu,fp { n{ |sy{ 4zsunpt{noy }s p}, x^x s u{,ou ,6 |puxn{8
 , "xu,fp { n{ |sy{ 4zsunpt{noy }s p}, x^x s u{,ou 56 |puxn{8
 ? "xu,fp { n{ |sy{ 4zsunpt{noy }s p}, x^x s u{,ou + }{n{8

B : 5 0 * :% * ; ts...sq{

A ' , c

E €or xu{q{r 4qp|},p y{r8 : u{...ysr 4tsn p y{r8
 ? *

a c * ; ? @ + A @ 96- : 3 9B-
 ; +(5B 4 D: 8:-

= * c ; B,(C #4 8

7 ' ; ,C(9? D:

g * * f ' ' ; 6(B -

7 ; +(BE :

WGFKCNVKJH XEY KEP [EHEPKGHCDKPC+ VPZFMJFOBUEOC\FJXR PHGC

s† zpy ~ us |oCEu{x npt qxz{np y{qo} q ...o~xnozplp z€or{|p •{...yp, uf nsy| ux s,}...tx{n{f q{zCErp
ro)n{ztw†ns zpy ~ x ...xu,n ...yp†o|xz€or z sts,nyp^uo†o † sts,nyouuo†o o~t{ru{uuw o~ r qu{np}w
{rys}x n{,o†o ...xu,nx(~xrv t},{(qzsyn{†ns}w ro | }v,o {r| u}ny{f s n{,oCE }no}xnv}w z}€ ~{n{ys†o,
{,x|xtwnoy z q |oCEtpz }n• ...sysq{ywrCE{uuw('o z,t^su z ,o|...ts,n ...o)n{z,p š} ~{n{ys†,p †
{,x|xtwnoy p q |oCEtpz }n• ...sysq{ywrCE{uuw ...ozpuzptx^}np}w q zpyo~x ...sysr †o†o ro)n{z,o• z ...xu,n
...yp†o|x z€or z Žptsyp qo~ozMwq{usq,oŠnozuo q{~py{np }n{y ...ypt{rp •n{y ...ypt{rp ^}no | }nwnv
,ou• rsuf †u o}o~p)n r{u Ń{rtw zt}uo ~sq...s,p ...{|Nwn{†ns('o ,oCEup†,fszpt ,oyp}nxz{^ us}s
z r...ozr{tvu }nv q{zpr{tsuuw r{up€ q }n{yp€ ...ypt{rz('o ...rtw†{•nv xnpt q{f



'yp}ny † |{ + yqu y zu ...onxCEuo)n



'yp}ny † |{ , y qup€ y zuw ...onxCEuo)n



'yp}ny † |{ ysqsyxz{y rtw zorp rtw qzotoCESuuw ...ozyw ...yp|suuw



'yp}ny † o}u{sup† }su}oyup| rp}...ts |{('o roqzotw qyx^uo zp~py{np yqu u{t{Šnxz{uuw



'yp}ny † |{ •xu,f • n{†|sy{



'yp}ny † |{ •xu,f • ,otpz{uuw(w,{ roqzotw zsunptwnoyx ,otpz{np}w(oruo^}uo ...yozny••p



Òotoz,x zsunptwnoy{ |oCEu{ qts†,{ u{€ptpnp



'yp}ny † |{ •xu,f • qzotoCESuuw ...yp|suuw('o }...ypw ror{n,ozo|x s•s,nx o€otorCESuuw

FDKHRPT ; Q KG[F PC IC

•s z)n{ztw†ns ~xrv2w, ...ysr|snp {~o ...{tvf ^sysq q{€p}ux ysŠn,x

•s ,t{r nv u{ ...yp}n† ~xrv2w, ...ysr|snp(u{...yp,t{r orw†

xrvns o~sysCEuq roz†p| zoto}}w| € |oCEu{ z}|o,nxz{np ...oznywup| ...ono,ol <yp|{†ns ~sq...s^ux rp)n{uf•

Ń~sy†{†ns z} z,{q z,p n{ u}nyx,f 'oro ~sq...s,p rtw ...or{tvŠo†o zp,oyp}n{uuw

ABCD KJUJ+ VP BHETYÿ DM KCNOFCP IGQ BRNOIKJX\$BQKRIE

š• ›— : •Ó›— ; •z nptvup, xz |,usuo {~o zp|,usuo ...ozu }n• z)n{uozt• nv}w u{ 966> w},y{zo)n ...yp ...oznoyuolx
xz |,usuu š} ...o...sysru{t{Šnxz{uuw },pr{•nv}w

ABCD KJUJ+ VP BHETYÿ DM KCNOFCP Q BRNOIKJX\$BQKRIE

9 šz|, : •p|, ; }z nto

+ "xu,f w n{†|sy{ 4zsunptwnoy zp|p,{ nv}w ^sysq ,6 €zptpu†

, "xu,f w n{†|sy{ 4zsunptwnoy zp|p,{ nv}w ^sysq 56 €zptpu8

? "xu,f w n{†|sy{ 4zsunptwnoy zp|p,{ nv}w ^sysq + †orpup8

B : 5 šz|, :•p,t ; zsunptwnoy

A 'yp}ny † |{ , y qu Šzpr,o)n

E yszsy} 4s,}...tx{n{fw zqpl,x8 : €r z...sysr 4s,}...tx{n{fw zt n,x€

_G[F\FE F%wJHXET V

•...oCEpz{uuw susy†; ?@ +A @ 96- : 3 9B-

œ{ru{ Š, rtpz }nv; +(5B 4 D: 8:-

• zo }ptvup† qzx, zsunptwnoy{; B,(C #4 8

>{,} ...yono, ...oznyw x zsunptwnoy,C(9? D:

'o}pt{uuw }nyx|x z ysCEp| †onozuo}n; 6(B -

>{,} Šzpr, }nv ...oznyw ; +(BE :