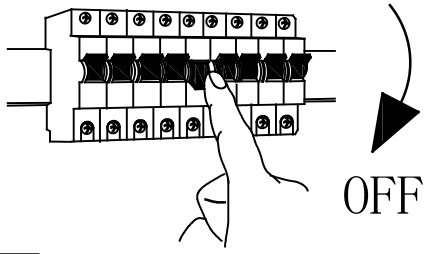
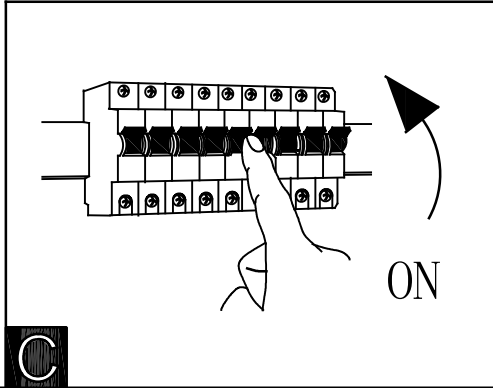
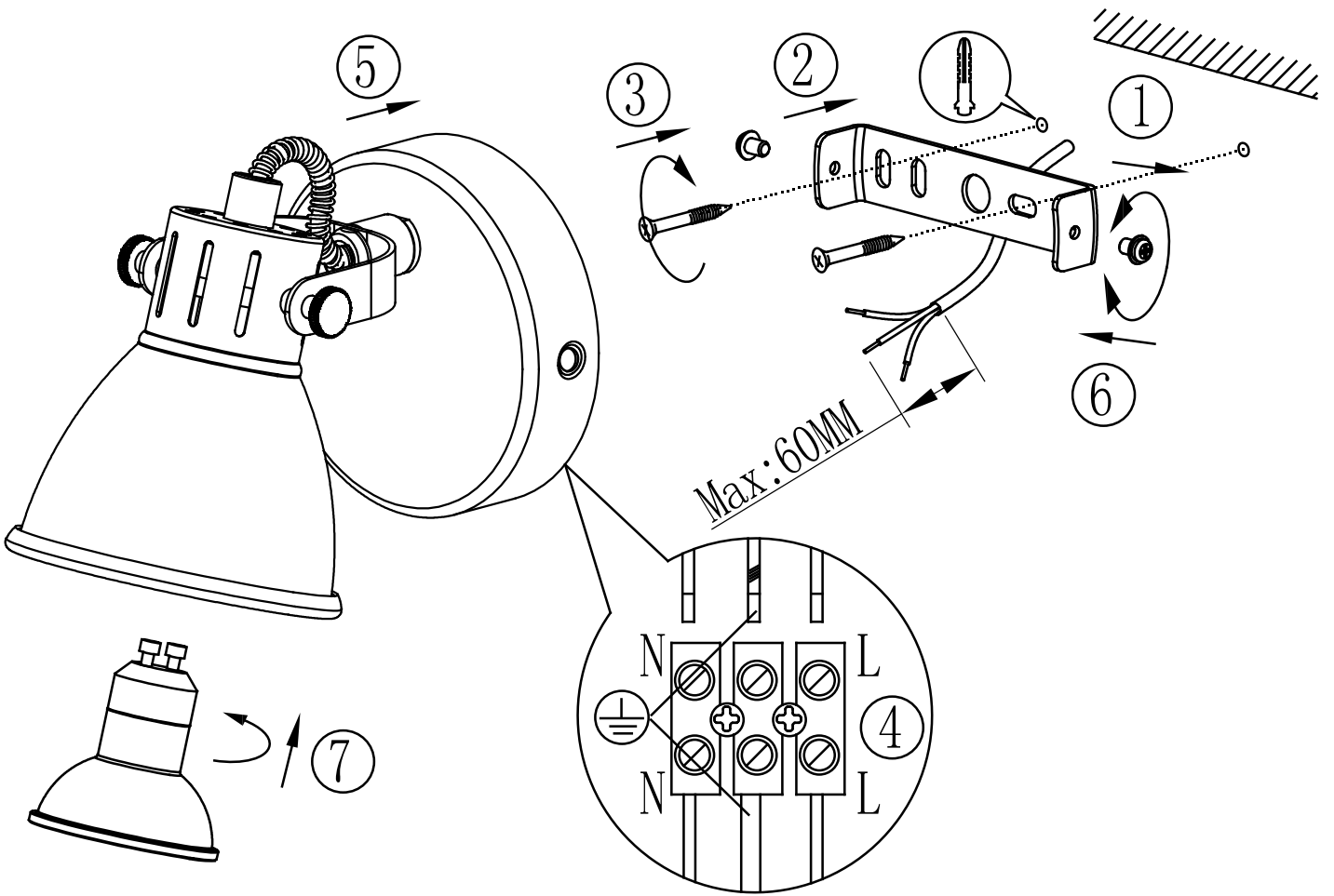

B**A****C**

B96552

www.eglo.com