

ARTWORK

Master Ref: **PHL449172**
 TR Ref: **TR2052566**
 Brand: PHILIPS
 Brand execution: HUE White
 Product name:
 Article Number: 50633/**/P7 / 50634/**/P7
 Region: Trident UK
 Template Ref: As Previous
 Artwork 12NC: 440402911462
 Die cut 12NC:
 Barcode: N/A
 CRC Number:
 Action: **C**
 Date: 02/02/2021

Project Manager: Arno van den Biggelaar

Trident Artist: Oli Hayton

Technical & Non Printing Items
 Dieline Guides

Colours:

Black	1
	2%

PHILIPS

TRIDENT

Trident UK, Connaught House, Connaught Road,
 Kingswood Business Park, Hull, HU7 3AP, England.
 T: +44 (0) 01482 828100

Please note that any low resolution paper Canon colour copies associated with this job should be referred to for content, layout and colour separation only.

UNDER NO CIRCUMSTANCES SHOULD THIS ARTWORK BE ALTERED WITHOUT PRIOR PERMISSION FROM TRIDENT.

ARTWORK

Master Ref: **PHL449172**
 TR Ref: **TR2052566**
 Brand: PHILIPS
 Brand execution: HUE White
 Product name:
 Article Number: 50633/**/P7 / 50634/**/P7
 Region: Trident UK
 Template Ref: As Previous
 Artwork 12NC: 440402911462
 Die cut 12NC:
 Barcode: N/A
 CRC Number:
 Action: **C**
 Date: 02/02/2021

Project Manager: Arno van den Biggelaar

Trident Artist: Oli Hayton

Technical & Non Printing Items

■ DieLine ■ Guides

Colours:



PHILIPS



Trident UK, Connaught House, Connaught Road,
 Kingswood Business Park, Hull, HU7 3AP, England.
 T: +44 (0) 01482 828100

Please note that any low resolution paper Canon colour copies associated with this job should be referred to for content, layout and colour separation only.

UNDER NO CIRCUMSTANCES SHOULD THIS ARTWORK BE ALTERED WITHOUT PRIOR PERMISSION FROM TRIDENT.

100 mm

120 mm

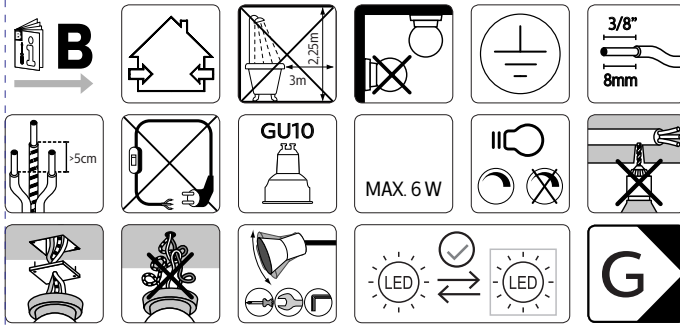
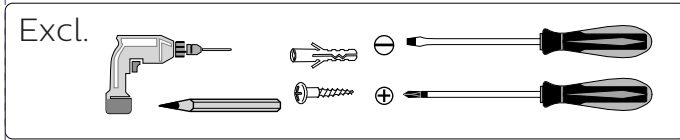
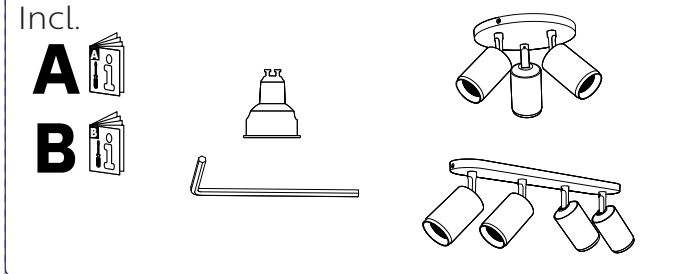

2

ARTWORK

Master Ref: **PHL449172**
TR Ref: **TR2052566**
Brand: PHILIPS
Brand execution: HUE White
Product name:
Article Number: 50633/**/P7 / 50634/**/P7
Region: Trident UK
Template Ref: As Previous
Artwork 12NC: 440402911462
Die cut 12NC:
Barcode: N/A
CRC Number:
Action: **C**
Date: 02/02/2021

Project Manager: Arno van den Biggelaar

Trident Artist: Oli Hayton

Technical & Non Printing Items

■ Dieline ■ Guides

Colours:

Black	1
	2th

PHILIPS



Trident UK, Connaught House, Connaught Road,
Kingswood Business Park, Hull, HU7 3AP, England.
T: +44 (0) 01482 828100

Please note that any low resolution paper Canon colour
copies associated with this job should be referred to for
content, layout and colour separation only.

UNDER NO CIRCUMSTANCES SHOULD THIS
ARTWORK BE ALTERED WITHOUT PRIOR
PERMISSION FROM TRIDENT.

100 mm

120 mm

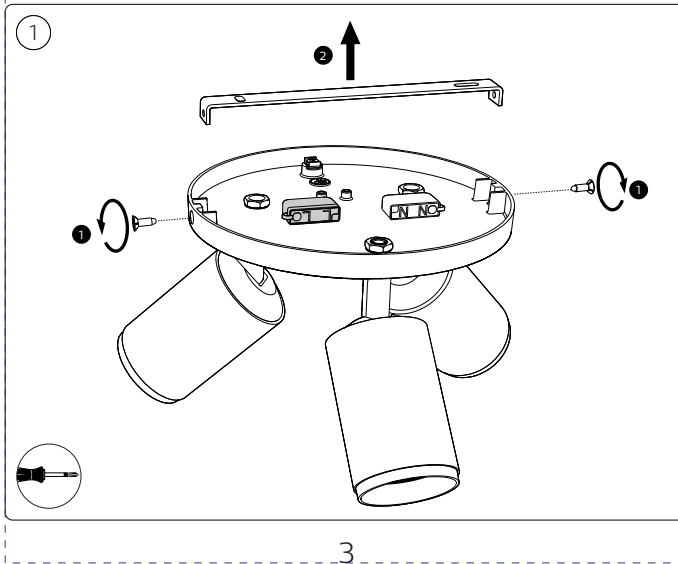
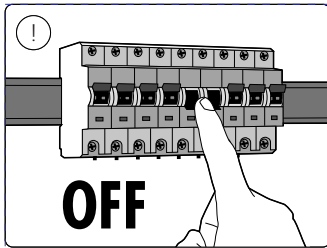

ARTWORK

Master Ref: **PHL449172**
TR Ref: **TR2052566**
Brand: PHILIPS
Brand execution: HUE White
Product name:
Article Number: 50633/**/P7 / 50634/**/P7
Region: Trident UK
Template Ref: As Previous
Artwork 12NC: 440402911462
Die cut 12NC:
Barcode: N/A
CRC Number:
Action: **C**
Date: 02/02/2021

Project Manager: Arno van den Biggelaar

Trident Artist: Oli Hayton

Technical & Non Printing Items

■ Dieline ■ Guides

Colours:

Black	1
	2th

PHILIPS



Trident UK, Connaught House, Connaught Road,
Kingswood Business Park, Hull, HU7 3AP, England.
T: +44 (0) 01482 828100

Please note that any low resolution paper Canon colour
copies associated with this job should be referred to for
content, layout and colour separation only.

UNDER NO CIRCUMSTANCES SHOULD THIS
ARTWORK BE ALTERED WITHOUT PRIOR
PERMISSION FROM TRIDENT.

100 mm

120 mm

2a

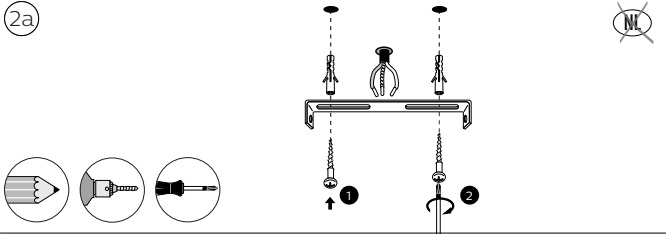

2b

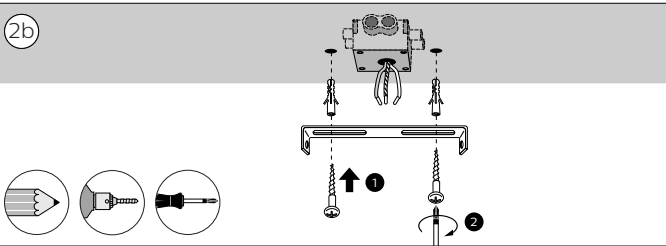

2c

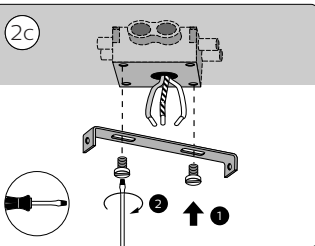

4

ARTWORK

Master Ref: **PHL449172**
TR Ref: **TR2052566**
Brand: PHILIPS
Brand execution: HUE White
Product name:
Article Number: 50633/**/P7 / 50634/**/P7
Region: Trident UK
Template Ref: As Previous
Artwork 12NC: 440402911462
Die cut 12NC:
Barcode: N/A
CRC Number:
Action: **C**
Date: 02/02/2021

Project Manager: Arno van den Biggelaar

Trident Artist: Oli Hayton

Technical & Non Printing Items

■ Dieline ■ Guides

Colours:



PHILIPS



TRIDENT
Trident UK, Connaught House, Connaught Road,
Kingswood Business Park, Hull, HU7 3AP, England.
T: +44 (0) 01482 828100

Please note that any low resolution paper Canon colour copies associated with this job should be referred to for content, layout and colour separation only.

UNDER NO CIRCUMSTANCES SHOULD THIS ARTWORK BE ALTERED WITHOUT PRIOR PERMISSION FROM TRIDENT.

100 mm

120 mm

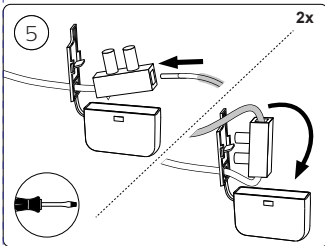
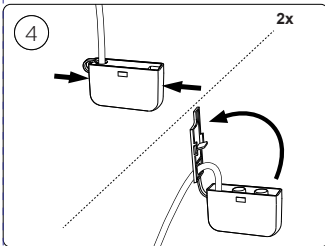
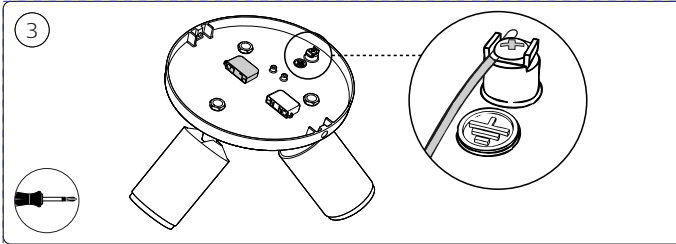

5

ARTWORK

Master Ref: **PHL449172**
TR Ref: **TR2052566**
Brand: PHILIPS
Brand execution: HUE White
Product name:
Article Number: 50633/**/P7 / 50634/**/P7
Region: Trident UK
Template Ref: As Previous
Artwork 12NC: 440402911462
Die cut 12NC:
Barcode: N/A
CRC Number:
Action: **C**
Date: 02/02/2021

Project Manager: Arno van den Biggelaar

Trident Artist: Oli Hayton

Technical & Non Printing Items

■ Dieline ■ Guides

Colours:

Black	1
	3%

PHILIPS



TRIDENT

Trident UK, Connaught House, Connaught Road,
Kingswood Business Park, Hull, HU7 3AP, England.
T: +44 (0) 01482 828100

Please note that any low resolution paper Canon colour
copies associated with this job should be referred to for
content, layout and colour separation only.

UNDER NO CIRCUMSTANCES SHOULD THIS
ARTWORK BE ALTERED WITHOUT PRIOR
PERMISSION FROM TRIDENT.

100 mm

120 mm

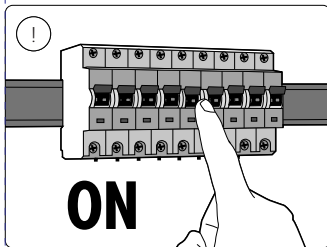
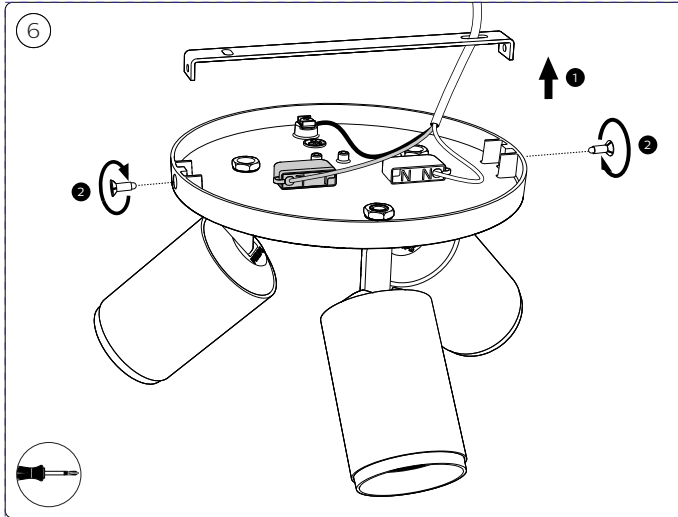

6

ARTWORK

Master Ref: **PHL449172**
TR Ref: **TR2052566**
Brand: PHILIPS
Brand execution: HUE White
Product name:
Article Number: 50633/**/P7 / 50634/**/P7
Region: Trident UK
Template Ref: As Previous
Artwork 12NC: 440402911462
Die cut 12NC:
Barcode: N/A
CRC Number:
Action: **C**
Date: 02/02/2021

Project Manager: Arno van den Biggelaar

Trident Artist: Oli Hayton

Technical & Non Printing Items

■ Dieline ■ Guides

Colours:

Black	1
	2/3

PHILIPS



TRIDENT

Trident UK, Connaught House, Connaught Road,
Kingswood Business Park, Hull, HU7 3AP, England.
T: +44 (0) 01482 828100

Please note that any low resolution paper Canon colour
copies associated with this job should be referred to for
content, layout and colour separation only.

UNDER NO CIRCUMSTANCES SHOULD THIS
ARTWORK BE ALTERED WITHOUT PRIOR
PERMISSION FROM TRIDENT.

100 mm

120 mm

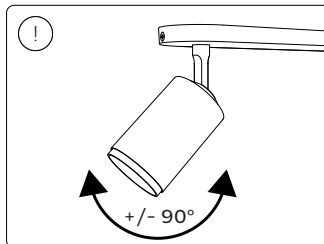
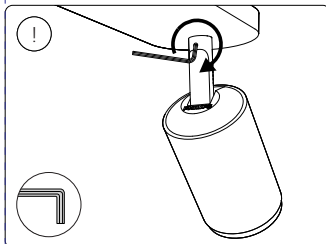
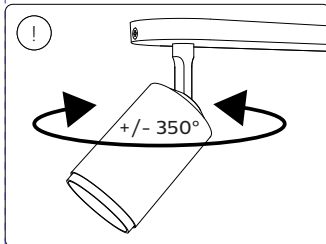
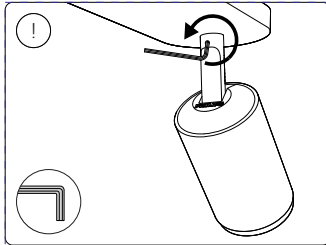

7

ARTWORK

Master Ref: **PHL449172**
TR Ref: **TR2052566**
Brand: PHILIPS
Brand execution: HUE White
Product name:
Article Number: 50633/**/P7 / 50634/**/P7
Region: Trident UK
Template Ref: As Previous
Artwork 12NC: 440402911462
Die cut 12NC:
Barcode: N/A
CRC Number:
Action: **C**
Date: 02/02/2021

Project Manager: Arno van den Biggelaar

Trident Artist: Oli Hayton

Technical & Non Printing Items

■ Dieline ■ Guides

Colours:



PHILIPS



TRIDENT

Trident UK, Connaught House, Connaught Road,
Kingswood Business Park, Hull, HU7 3AP, England.
T: +44 (0) 01482 828100

Please note that any low resolution paper Canon colour
copies associated with this job should be referred to for
content, layout and colour separation only.

UNDER NO CIRCUMSTANCES SHOULD THIS
ARTWORK BE ALTERED WITHOUT PRIOR
PERMISSION FROM TRIDENT.

100 mm

120 mm

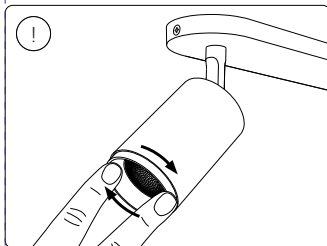
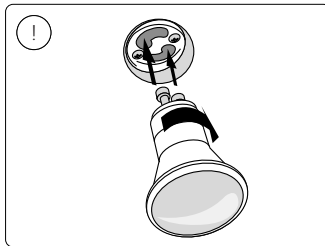
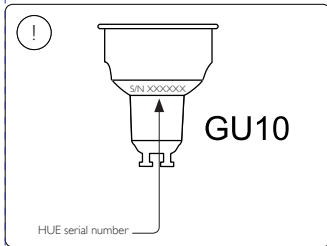
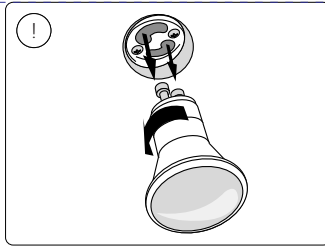
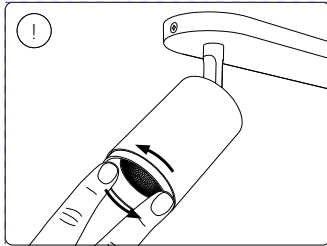

8

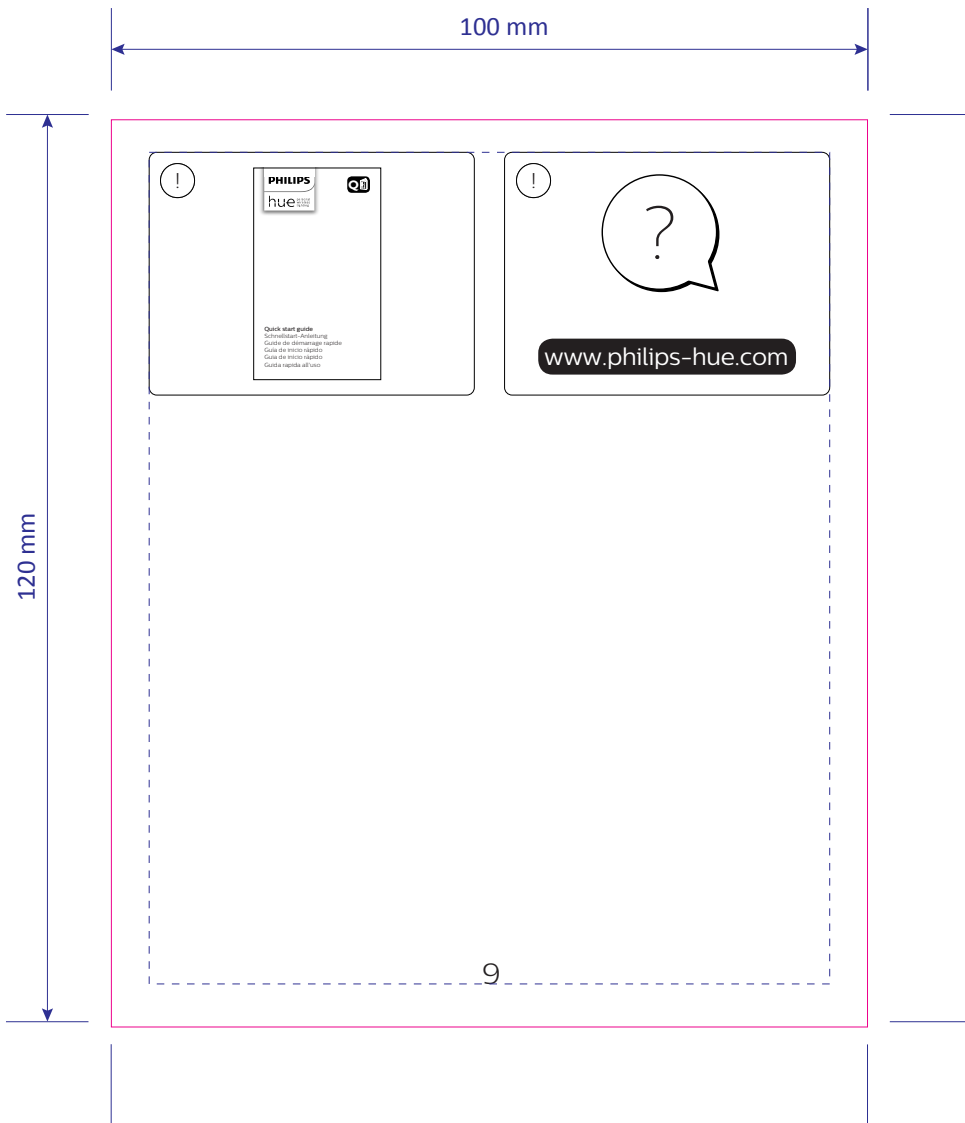

ARTWORK

Master Ref: **PHL449172**
 TR Ref: **TR2052566**
 Brand: PHILIPS
 Brand execution: HUE White
 Product name:
 Article Number: 50633/**/P7 / 50634/**/P7
 Region: Trident UK
 Template Ref: As Previous
 Artwork 12NC: 440402911462
 Die cut 12NC:
 Barcode: N/A
 CRC Number:
 Action: **C**
 Date: 02/02/2021

Project Manager: Arno van den Biggelaar

Trident Artist: Oli Hayton

Technical & Non Printing Items

Dieline
 Guides

Colours:



PHILIPS



TRIDENT

Trident UK, Connaught House, Connaught Road,
 Kingswood Business Park, Hull, HU7 3AP, England.
 T: +44 (0) 01482 828100

Please note that any low resolution paper Canon colour copies associated with this job should be referred to for content, layout and colour separation only.

UNDER NO CIRCUMSTANCES SHOULD THIS
 ARTWORK BE ALTERED WITHOUT PRIOR
 PERMISSION FROM TRIDENT.

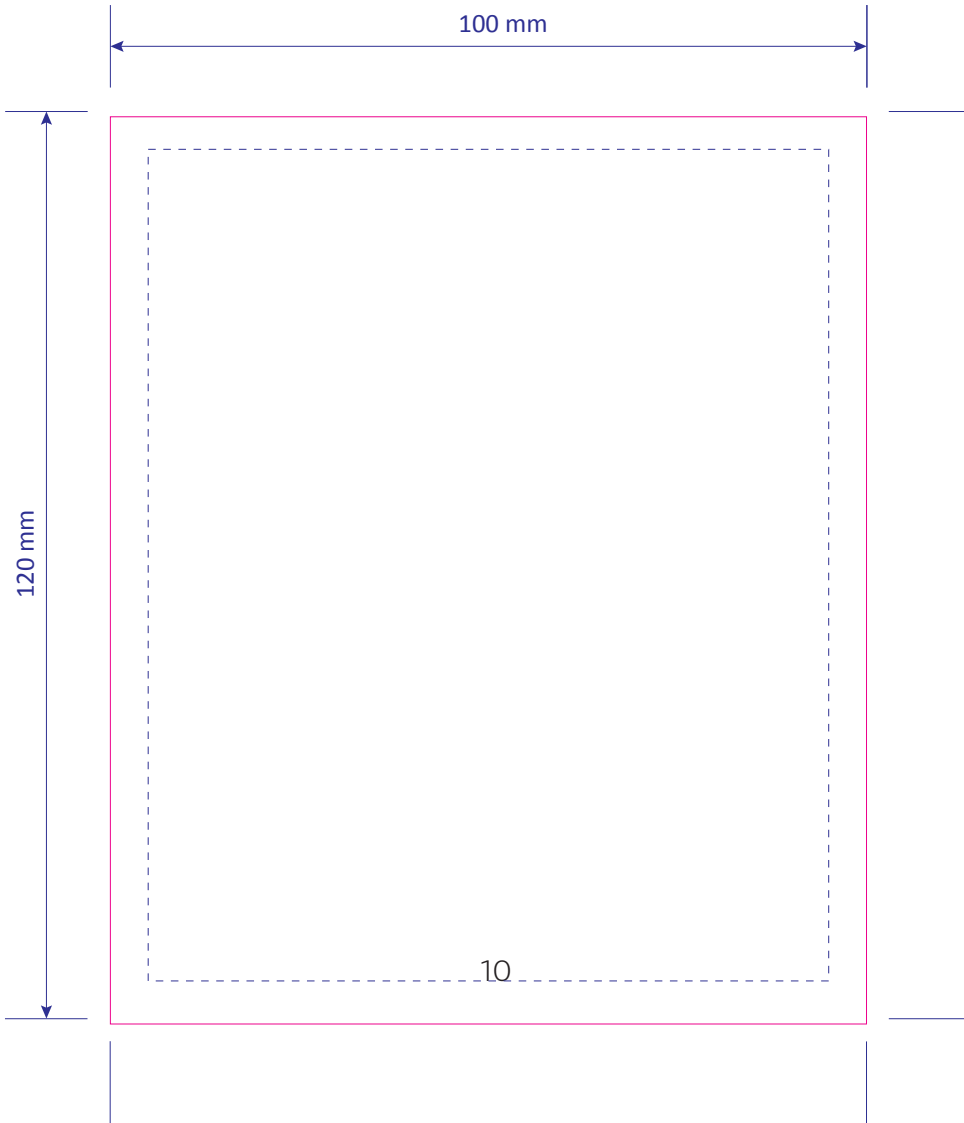

ARTWORK

Master Ref: **PHL449172**
 TR Ref: **TR2052566**
 Brand: PHILIPS
 Brand execution: HUE White
 Product name:
 Article Number: 50633/**/P7 / 50634/**/P7
 Region: Trident UK
 Template Ref: As Previous
 Artwork 12NC: 440402911462
 Die cut 12NC:
 Barcode: N/A
 CRC Number:
 Action: **C**
 Date: 02/02/2021

Project Manager: Arno van den Biggelaar

Trident Artist: Oli Hayton

Technical & Non Printing Items
■ Die Line ■ Guides

Colours:

Black	1
	2th

PHILIPS



TRIDENT
 Trident UK, Connaught House, Connaught Road,
 Kingswood Business Park, Hull, HU7 3AP, England.
 T: +44 (0) 01482 828100

Please note that any low resolution paper Canon colour copies associated with this job should be referred to for content, layout and colour separation only.

UNDER NO CIRCUMSTANCES SHOULD THIS ARTWORK BE ALTERED WITHOUT PRIOR PERMISSION FROM TRIDENT.

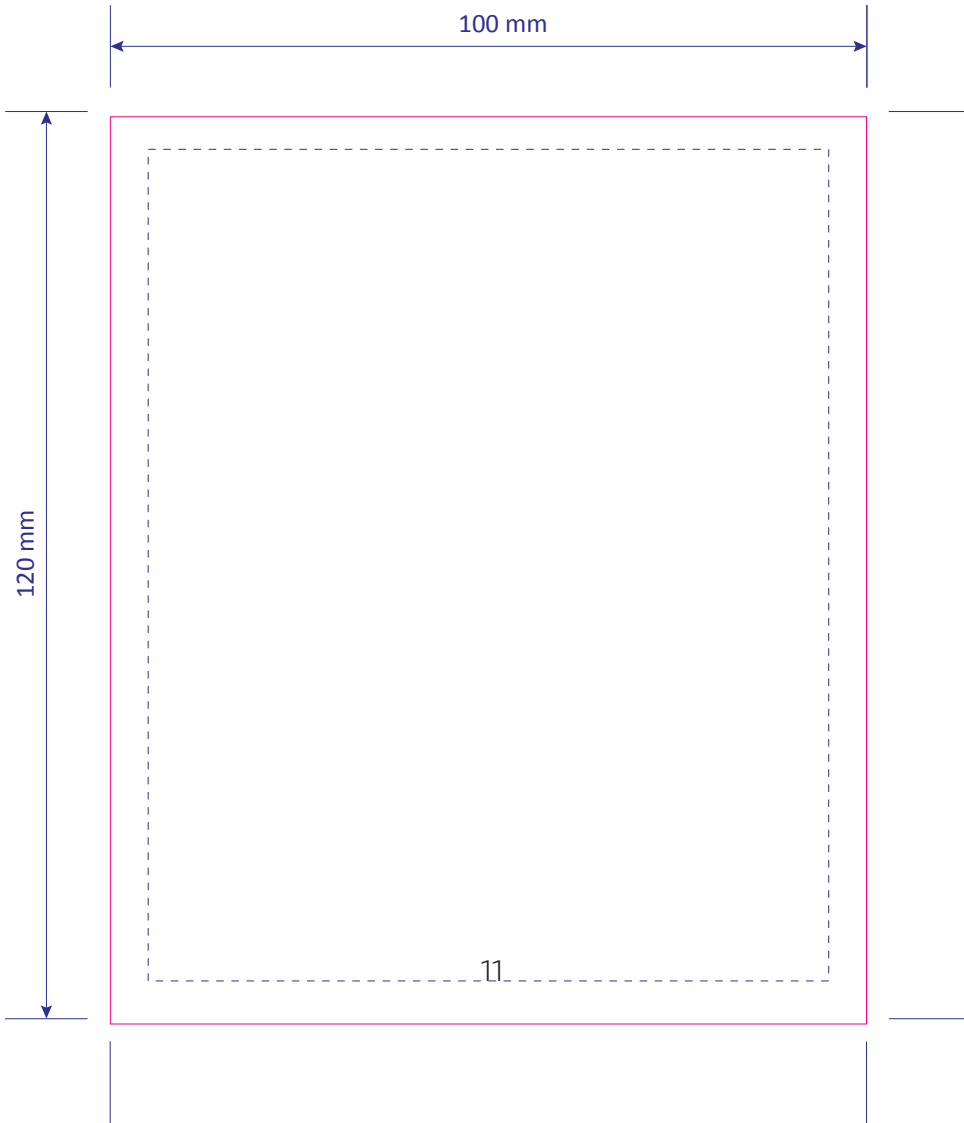

ARTWORK

Master Ref: **PHL449172**
TR Ref: **TR2052566**
Brand: PHILIPS
Brand execution: HUE White
Product name:
Article Number: 50633/**/P7 / 50634/**/P7
Region: Trident UK
Template Ref: As Previous
Artwork 12NC: 440402911462
Die cut 12NC:
Barcode: N/A
CRC Number:
Action: **C**
Date: 02/02/2021

Project Manager: Arno van den Biggelaar

Trident Artist: Oli Hayton

Technical & Non Printing Items
■ Dieline ■ Guides

Colours:

Black	1
	2th

PHILIPS



TRIDENT
Trident UK, Connaught House, Connaught Road,
Kingswood Business Park, Hull, HU7 3AP, England.
T: +44 (0) 01482 828100

Please note that any low resolution paper Canon colour copies associated with this job should be referred to for content, layout and colour separation only.

UNDER NO CIRCUMSTANCES SHOULD THIS ARTWORK BE ALTERED WITHOUT PRIOR PERMISSION FROM TRIDENT.

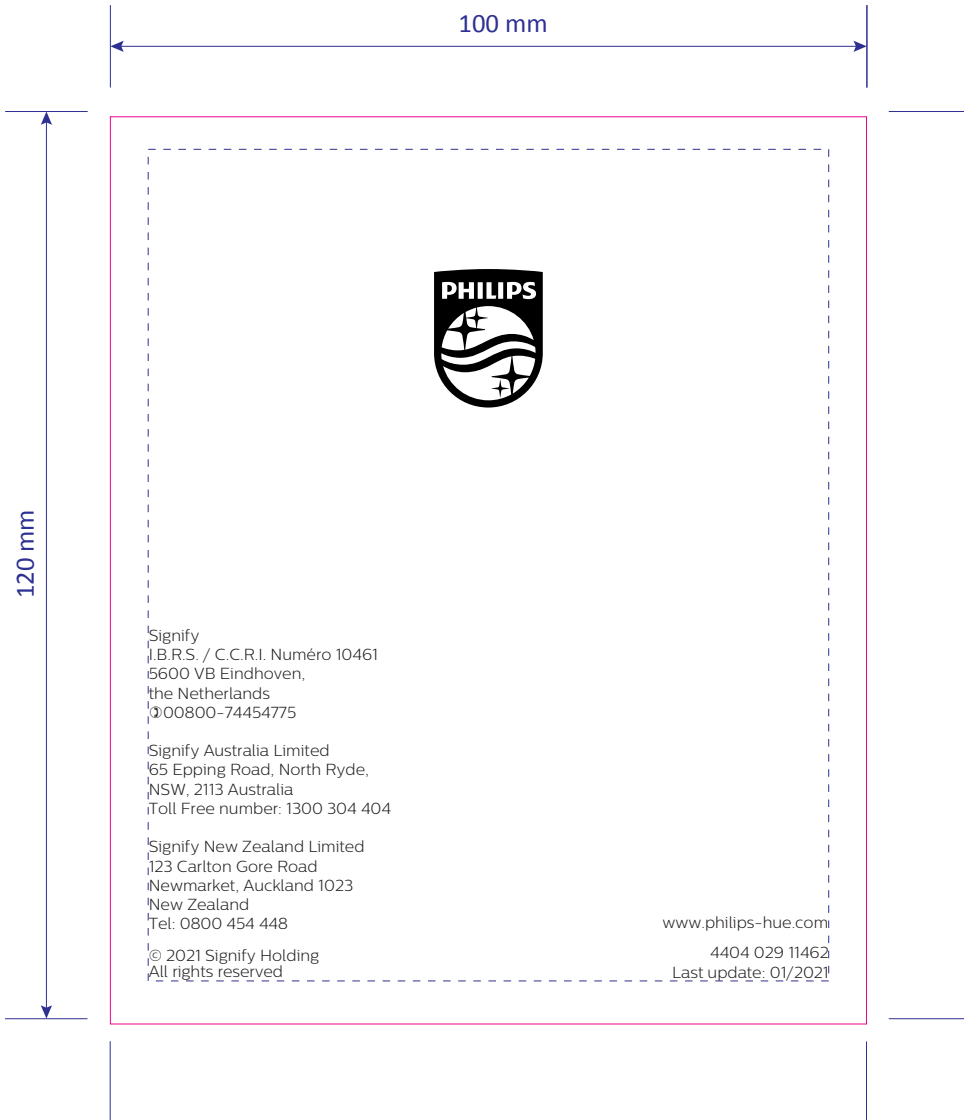

ARTWORK

Master Ref: **PHL449172**
 TR Ref: **TR2052566**
 Brand: PHILIPS
 Brand execution: HUE White
 Product name:
 Article Number: 50633/**/P7 / 50634/**/P7
 Region: Trident UK
 Template Ref: As Previous
 Artwork Ref: 440402911462
 Die cut 12NC:
 Barcode: N/A
 CRC Number:
 Action: **C**
 Date: 02/02/2021

Project Manager: Arno van den Biggelaar

Trident Artist: Oli Hayton

Technical & Non Printing Items

■ Dieline ■ Guides

Colours:

Black	1
	2th

PHILIPS



TRIDENT

Trident UK, Connaught House, Connaught Road,
 Kingswood Business Park, Hull, HU7 3AP, England.
 T: +44 (0) 01482 828100

Please note that any low resolution paper Canon colour copies associated with this job should be referred to for content, layout and colour separation only.

UNDER NO CIRCUMSTANCES SHOULD THIS ARTWORK BE ALTERED WITHOUT PRIOR PERMISSION FROM TRIDENT.

Signify
 J.B.R.S. / C.C.R.I. Numéro 10461
 5600 VB Eindhoven,
 the Netherlands
 ☎00800-74454775

Signify Australia Limited
 65 Epping Road, North Ryde,
 NSW, 2113 Australia
 ☎Toll Free number: 1300 304 404

Signify New Zealand Limited
 123 Carlton Gore Road
 Newmarket, Auckland 1023
 New Zealand
 ☎Tel: 0800 454 448

www.philips-hue.com

4404 029 11462

© 2021 Signify Holding
 All rights reserved

Last update: 01/2021