

4018211 207930

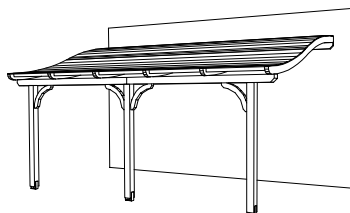

4018211 207954

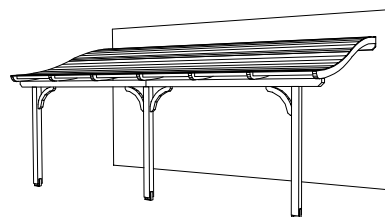

4018211 207978

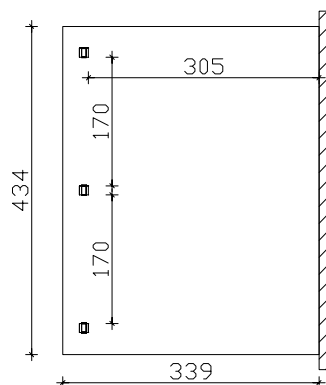

Grundriss

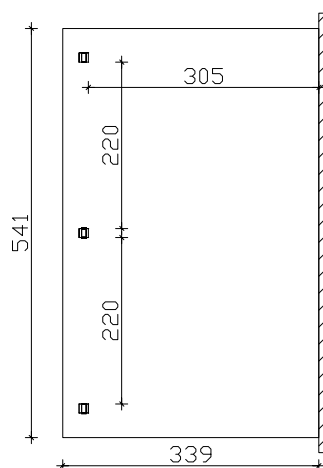

Grundriss

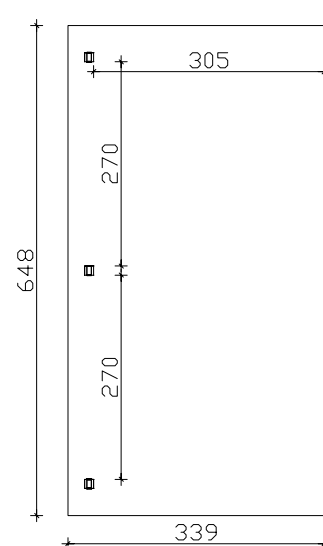

Grundriss

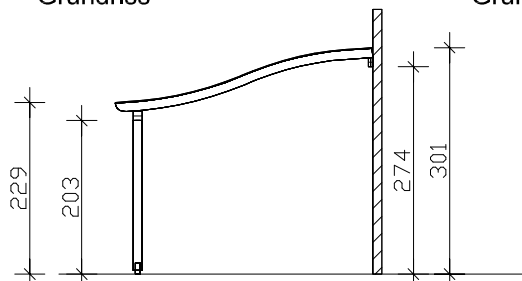

Seitenansicht

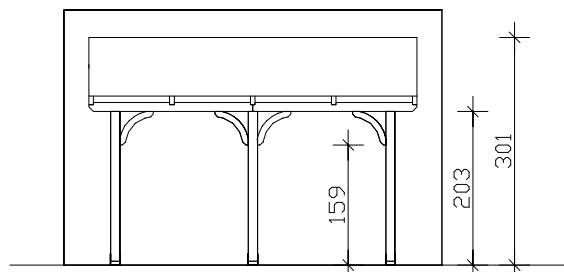

Frontansicht

M 1:100

"Venezia" Terrassenüberdachung, 339cm x 434cm / 541cm / 648cm

Technische Information / Baubeschreibung



Holzart / Eisenteile	Leimholz, unbehandelt / verzinkt
Pfosten	3 Stück 12x12x198cm
Dacheindeckung	Polycarbonat Doppelstegplatten 10mm (transparent)
Schneelast	sk = 1,35kN/m²
Tiefe x Breite	339cm x 434cm / 541cm / 648cm
Höhe / Durchgang	229-301cm / 203cm (inkl. Abstand zum Boden, Aufschraubstütze = 5cm)
Fläche (umb.Raum)	14,71m² (41,03m³) / 18,33m² (50,23m³) / 21,97m² (59,42m³)
Verpackungseinheit	B x L x H 110 x 366 x 38-46cm / Gewicht 260-335kg
Inklusive	Montagematerial, Aufschraubstützen, Kopfbänder, Aufbauanleitung (ohne Dübel für Wandbefestigung, ohne Wandabdichtungsprofile)