

4018211 201297

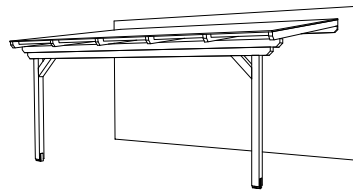

4018211 201372

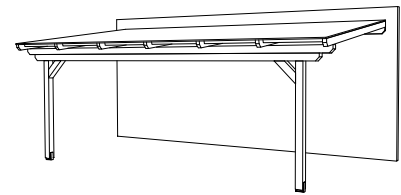

4018211 201457

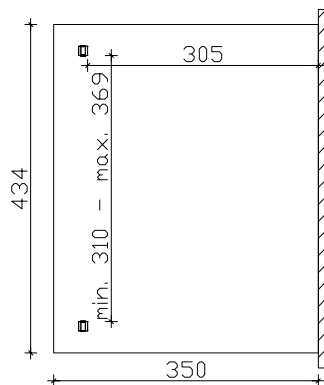

Grundriss

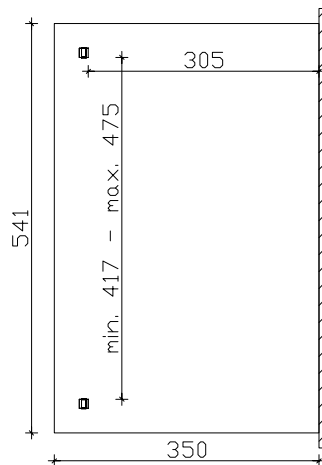

Grundriss

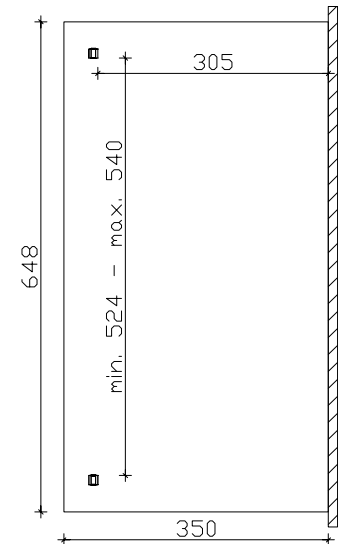

Grundriss

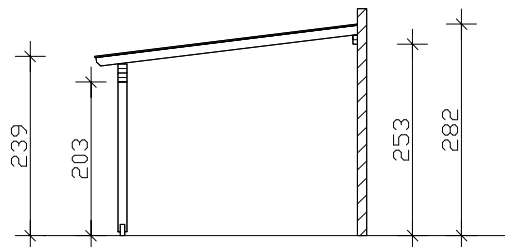

Seitenansicht

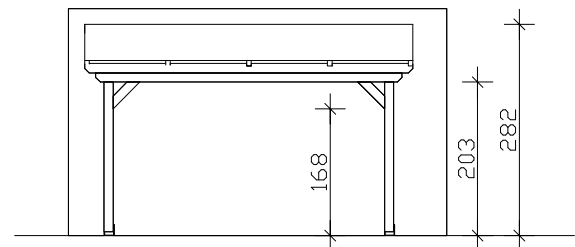

Frontansicht

M 1:100

"Ancona" Terrassenüberdachung, 350cm x 434cm / 541cm / 648cm

Technische Information / Baubeschreibung



Holzart / Eisenteile	Leimholz, unbehandelt / verzinkt
Pfosten	2 Stück 12x12x198cm
Dacheindeckung	Polycarbonat Doppelstegplatten 16mm (transparent)
Schneelast	sk = 1,00kN/m²
Tiefe x Breite	350cm x 434cm / 541cm / 648cm
Höhe / Durchgang	239-282cm / 203cm (inkl. Abstand zum Boden, Aufschraubstütze = 5cm)
Fläche (umb.Raum)	15,19m² (37,35m³) / 18,94m² (46,56m³) / 22,68m² (55,77m³)
Dachneigung	7°
Verpackungseinheit	B x L x H 110 x 450-655 x 38-46cm / Gewicht 255-350kg
Inklusive	Montagematerial, Aufschraubstützen, Kopfbänder, Aufbauanleitung (ohne Dübel für Wandbefestigung, ohne Wandabdichtungsprofile)